



# Bedroom Collections



Allentown | Barrington | Brookstone | Cabin Creek | Canyon Creek  
Chelsea | Claremont Mission | Hamilton | Lew Modern | Lewiston | Luellen  
Manhattan | Monticello | Olde Cottage | Regency | Rosedale  
Shoreview | Sonora Timber Mill | Wilkensburg





*Allentown*  
Bedroom Collection

# Allentown



## Allentown Bedroom Collection w/ Allentown Bed

- AL-4017Q Queen Bed
- AL-4054 Dresser
- AL-4042 Night Stand
- MI-4030 Mirror
- AL-4063 Chest

Shown above in **Brown Maple** with # 4080 Base  
**OCS - 133 Tundra** and **4318BRPW Hardware**

### Standard Features:



4318BRPW Knobs



Standard with side-mount drawer slides



Stained poplar drawer boxes



Dovetailed bed slats

### Available Upgrades:

- Any Hardware on our Hardware options sheet
- Undermount soft close slides [See Price List]

## Base Options for Allentown



# 4080 Base



# 4081 Base



# 4082 Base



# 4083 Base

All units 3"  
 Lower for  
 Base # 4082

# Allentown Night Stands



**AL-4042**  
Night Stand shown

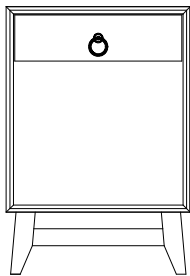

**AL-4040 Night Stand**  
19¼"w 28"h 16½"d  
w/1 drawer

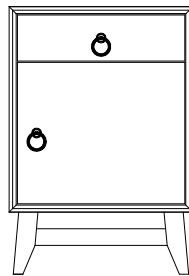

**AL-4041 Night Stand**  
19¼"w 28"h 16½"d  
w/1 drawer, 1 door

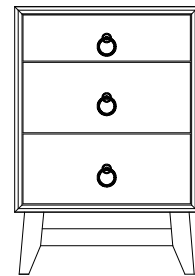

**AL-4042 Night Stand**  
19¼"w 28"h 16½"d  
w/3 drawers

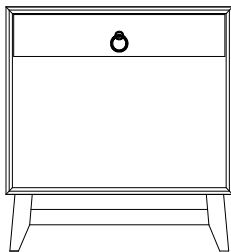

**AL-4043 Night Stand**  
26"w 28"h 16½"d  
w/1 drawer

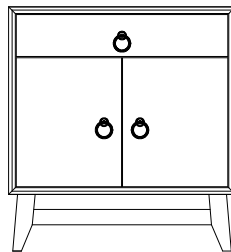

**AL-4044 Night Stand**  
26"w 28"h 16½"d  
w/1 drawer, 2 doors

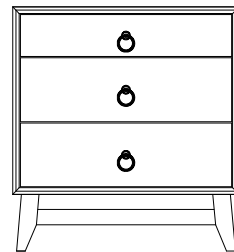

**AL-4045 Night Stand**  
26"w 28"h 16½"d  
w/3 drawers

# Allentown Chests & Miscellaneous



**AL-4063**  
Chest shown

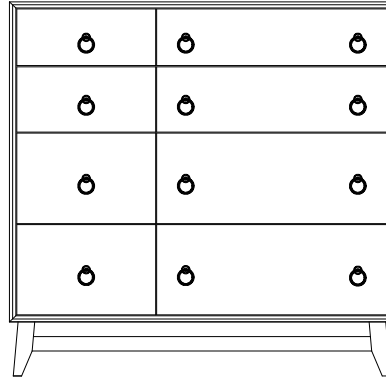

**AL-4048 Chest**  
46¼"w 45"h 20"d  
w/8 drawers

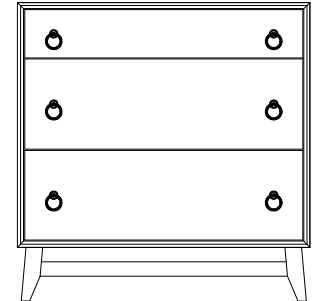

**AL-4049 Chest**  
35¼"w 37"h 20"d  
w/3 drawers

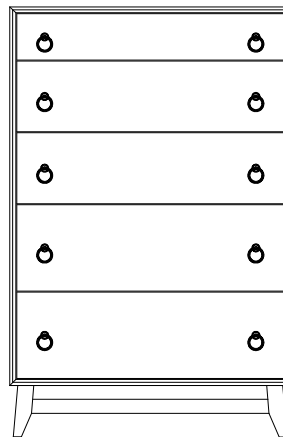

**AL-4063 Chest**  
35¼"w 54"h 20"d  
w/5 drawers

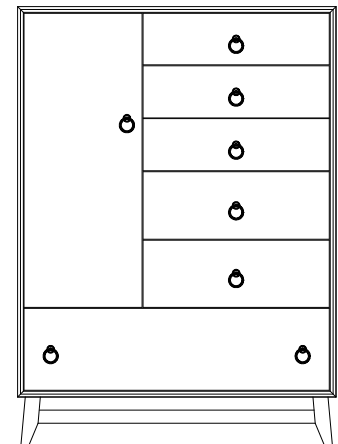

**AL-4052 Chifferobe**  
42"w 58¼"h 20"d  
w/6 drawers, 1 door,  
2 adjustable shelves

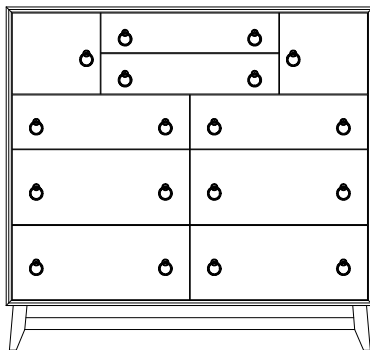

**AL-4053 His & Hers**  
53½"w 50½"h 20"d  
w/8 drawers, 2 doors

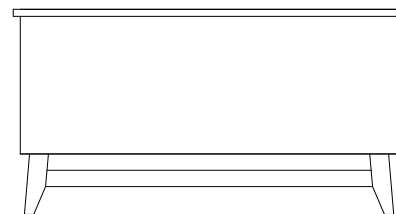

**AL-4039 Blanket Chest**  
42"w 22"h 21½"d

Available  
with aromatic  
cedar bottom

# Allentown Dressers



AL-4054 Dresser shown with MI-4030 Mirror

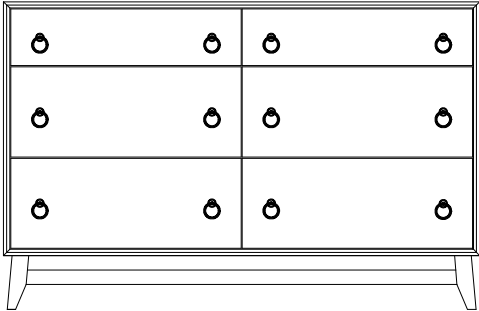

**AL-4054**  
57¼" w 37" h 20" d  
w/6 drawers

Suggested Mirrors:  
**MI-4030**  
40" h 36" w

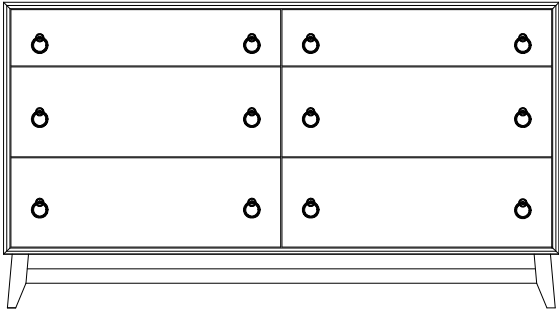

**AL-4055**  
67¼" w 37" h 20" d  
w/6 drawers

Suggested Mirrors:  
**MI-4031**  
40" h 46" w

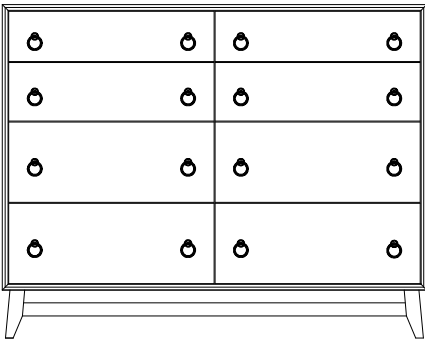

**AL-4060**  
57¼" w 45" h 20" d  
w/8 drawers

Suggested Mirrors:  
**MI-4032**  
32" h 42" w

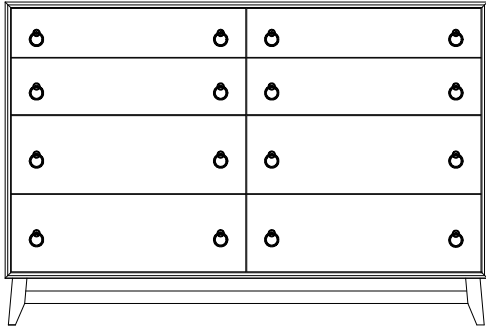

**AL-4061**  
67¼" w 45" h 20" d  
w/8 drawers

Suggested Mirrors:  
**MI-4033**  
32" h 52" w

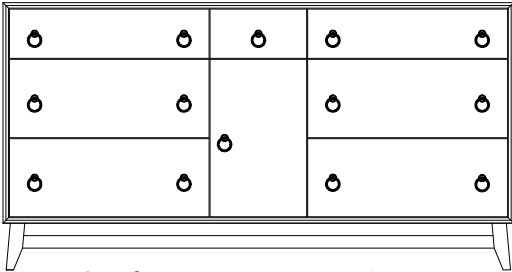

**AL-4056**  
70¾" w 37" h 20" d  
w/7 drawers, 1 door,  
1 adjustable shelf

Suggested Mirrors:  
**MI-4031**  
40" h 46" w



Plain Mirror

**MI-4030 Mirror**  
40" h 36" w

**MI-4031 Mirror**  
40" h 46" w

**MI-4032 Mirror**  
32" h 42" w

**MI-4033 Mirror**  
32" h 52" w

# Allentown Bed Frames



shown with Regular Footboard

## Allentown Bed

### Regular Footboard

Available with underbed storage options.

**AL-4017-K** (King)  
84 $\frac{5}{8}$ "w 87 $\frac{3}{4}$ "l  
HB 48"h ■ FB 18"h

**AL-4017-Q** (Queen)  
69"w 87 $\frac{3}{4}$ "l  
HB 48"h ■ FB 18"h

**AL-4017-F** (Full)  
61 $\frac{7}{8}$ "w 82 $\frac{3}{4}$ "l  
HB 48"h ■ FB 18"h

**AL-4017-T** (Twin)  
47"w 82 $\frac{3}{4}$ "l  
HB 48"h ■ FB 18"h

### Low Footboard

**AI-4025-K** (King)  
84 $\frac{5}{8}$ "w 87 $\frac{3}{4}$ "l  
HB 48"h ■ FB 14 $\frac{3}{4}$ "h

**AI-4025-Q** (Queen)  
69"w 87 $\frac{3}{4}$ "l  
HB 48"h ■ FB 14 $\frac{3}{4}$ "h

**AI-4025-F** (Full)  
61 $\frac{7}{8}$ "w 82 $\frac{3}{4}$ "l  
HB 48"h ■ FB 14 $\frac{3}{4}$ "h

**AI-4025-T** (Twin)  
47"w 82 $\frac{3}{4}$ "l  
HB 48"h ■ FB 14 $\frac{3}{4}$ "h

### Headboard Only

**AL-4033K-HB** (King)  
48" high

**AL-4033Q-HB** (Queen)  
48" high

**AL-4033F-HB** (Full)  
48" high

**AL-4033T-HB** (Twin)  
48" high

# Allentown Storage Rail Upgrades

## 12<sup>3</sup>/<sub>4</sub>" From Floor to Box Spring

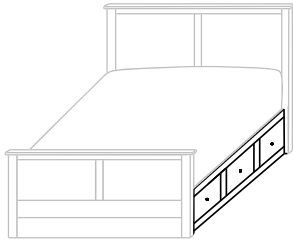

- With 3 drawers on each side
- 12<sup>3</sup>/<sub>4</sub>" from floor to Box Spring
- Inside drawer dimensions on all sizes  
9<sup>1</sup>/<sub>4</sub>"h 18<sup>7</sup>/<sub>8</sub>"w 22<sup>1</sup>/<sub>2</sub>"d

**532-SR-K** King – 6 drawers  
**532-SR-Q** Queen – 6 drawers  
**532-SR-F** Full – 6 drawers  
**532-SR-T** Twin – 3 drawers

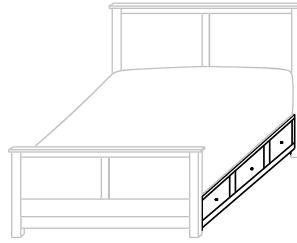

- With 3" Toe Kick
- With 3 drawers on each side
- 12<sup>3</sup>/<sub>4</sub>" from floor to Box Spring
- Inside drawer dimensions on all sizes  
6<sup>1</sup>/<sub>4</sub>"h 18<sup>7</sup>/<sub>8</sub>"w 22<sup>1</sup>/<sub>2</sub>"d

**234-SR-K** King – 6 drawers  
**234-SR-Q** Queen – 6 drawers  
**234-SR-F** Full – 6 drawers  
**234-SR-T** Twin – 3 drawers

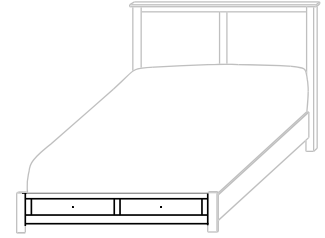

- 12<sup>3</sup>/<sub>4</sub>" from floor to Box Spring
- Inside drawer dimensions  
6<sup>1</sup>/<sub>4</sub>"h 22<sup>1</sup>/<sub>2</sub>"d  
(King) 31"w (Queen) 23<sup>1</sup>/<sub>4</sub>"w  
(Full) 19<sup>3</sup>/<sub>8</sub>"w (Twin) 29<sup>1</sup>/<sub>4</sub>"w

**685-FDS-K** King – 2 drawers  
**685-FDS-Q** Queen – 2 drawers  
**685-FDS-F** Full – 2 drawers  
**685-FDS-T** Twin – 1 drawer

## 19<sup>3</sup>/<sub>4</sub>" From Floor to Box Spring

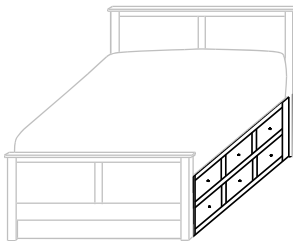

- With 6 drawers on each side
- Twin has 6 drawers on 1 side only
- 19<sup>3</sup>/<sub>4</sub>" from floor to Box Spring
- Inside drawer dimensions on all sizes  
6<sup>1</sup>/<sub>4</sub>"h 18<sup>7</sup>/<sub>8</sub>"w 22<sup>1</sup>/<sub>2</sub>"d

**654-SR-K** King – 12 drawers  
**654-SR-Q** Queen – 12 drawers  
**654-SR-F** Full – 12 drawers  
**654-SR-T** Twin – 6 drawers

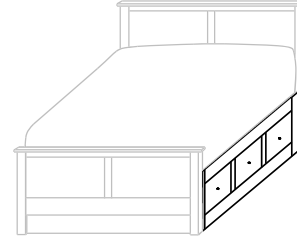

- With 3 drawers on each side
- 19<sup>3</sup>/<sub>4</sub>" from floor to Box Spring
- Inside drawer dimensions on all sizes  
10<sup>1</sup>/<sub>4</sub>"h 18<sup>7</sup>/<sub>8</sub>"w 22<sup>1</sup>/<sub>2</sub>"d

**325-SR-K** King – 6 drawers  
**325-SR-Q** Queen – 6 drawers  
**325-SR-F** Full – 6 drawers  
**325-SR-T** Twin – 3 drawers

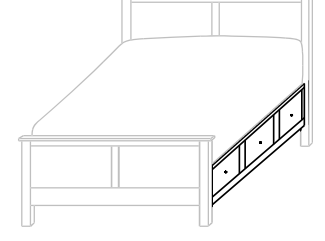

- With 7" Toe Kick
- With 3 drawers on each side
- 19<sup>3</sup>/<sub>4</sub>" from floor to Box Spring
- Inside drawer dimensions on all sizes  
9<sup>1</sup>/<sub>4</sub>"h 18<sup>7</sup>/<sub>8</sub>"w 22<sup>1</sup>/<sub>2</sub>"d

**236-SR-K** King – 6 drawers  
**236-SR-Q** Queen – 6 drawers  
**236-SR-F** Full – 6 drawers  
**236-SR-T** Twin – 3 drawers

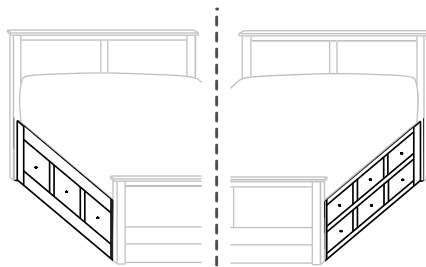

- With 3 drawers on one side and 6 drawers on other side
- 19<sup>3</sup>/<sub>4</sub>" from floor to Box Spring

**420-SR-K** King – 9 drawers  
**420-SR-Q** Queen – 9 drawers  
**420-SR-F** Full – 9 drawers  
 (Twin Not Available)

### Additional Upgrades

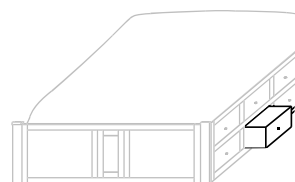

- With Step Stool Pullout in place of drawer

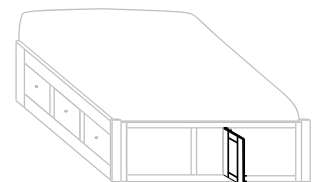

- With Door in Footboard to access area between rails





*Barrington*  
Bedroom Collection

# Barrington



## Barrington Bedroom Collection w/Barrington Bed

- BR-1414Q Queen Bed
- BR-1354 Dresser
- BR-1340 Night Stand
- MI-1630 Mirror
- BR-1350 Chest

Shown above in **Brown Maple** with **OCS-121 Smoke** and **K272-SN Hardware**

### Standard Features:



K 800-SN Knobs  
K272-SN Pulls



Standard with side-mount drawer slides

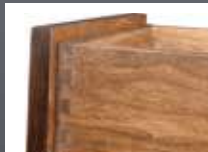

Stained poplar dovetailed drawers



Dovetailed bed slats

### Available Upgrades:

- Any hardware on our Hardware Options Sheet
- Undermount soft close slides [See Price List]



- ER-1930Q Elk Ridge Sleigh Bed
- BR-1345 Night Stand
- BR-1363 Chest
- BR-1360 Dresser
- MI-1632 Mirror

Shown in **Brown Maple** with **FC-19093 Dark Knight** and **24017-SN Hardware**

# Barrington Night Stands



**BR-1340**  
Night Stand shown

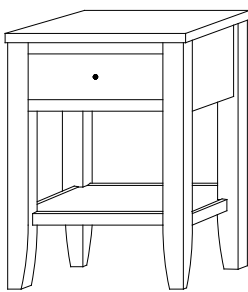

**BR-1340 Night Stand**  
19¾"w 28"h 17"d  
w/1 drawer

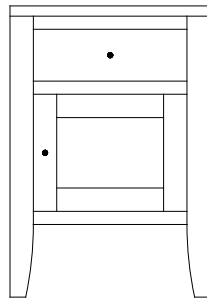

**BR-1341 Night Stand**  
19¼"w 28"h 16½"d  
w/1 drawer, 1 door

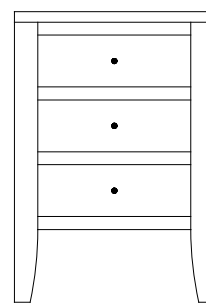

**BR-1342 Night Stand**  
19¼"w 28"h 16½"d  
w/3 drawers

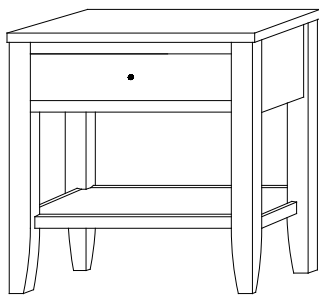

**BR-1343 Night Stand**  
26½"w 28"h 17"d  
w/1 drawer

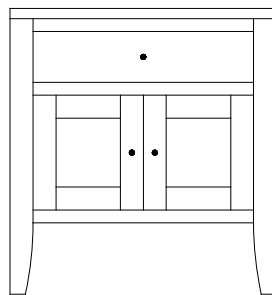

**BR-1344 Night Stand**  
26"w 28"h 16½"d  
w/1 drawer, 2 doors

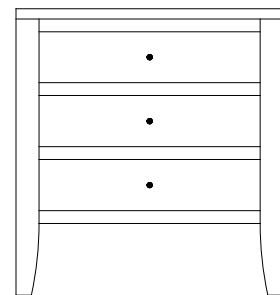

**BR-1345 Night Stand**  
26"w 28"h 16½"d  
w/3 drawers

# Barrington Lingeries & Chests



**BR-1350**  
Chest shown

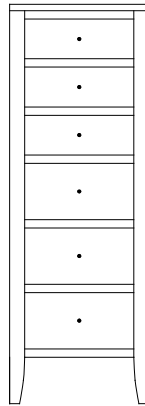

**BR-1346 Lingerie**  
21"w 60¼"h 20½"d  
w/6 drawers

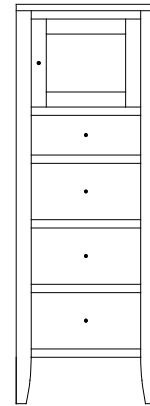

Available with  
mirror panel  
in door

**BR-1347 Lingerie**  
21"w 60¼"h 20½"d  
w/4 drawers, 1 wood  
door, 1 adjustable shelf

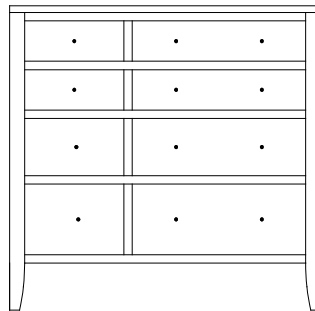

**BR-1348 Chest**  
46¼"w 45¼"h 20½"d  
w/8 drawers

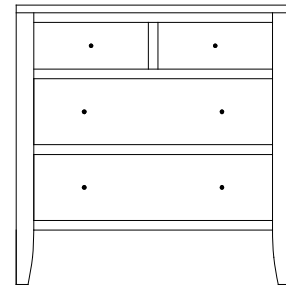

**BR-1349 Chest**  
35¼"w 36"h 20½"d  
w/4 drawers

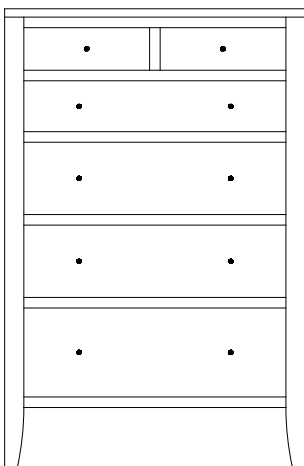

**BR-1350 Chest**  
35¼"w 54"h 20½"d  
w/6 drawers

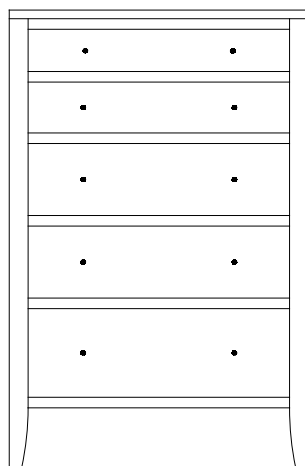

**BR-1363 Chest**  
35¼"w 54"h 20½"d  
w/5 drawers

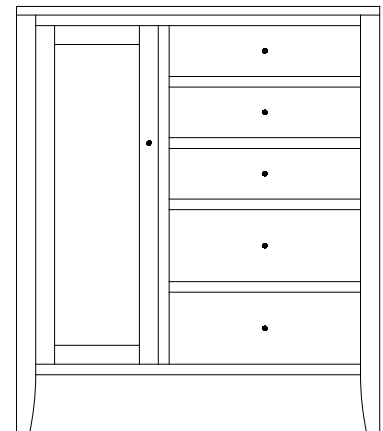

**BR-1351 Door Chest**  
42¾"w 50½"h 20½"d  
w/5 drawers, 1 door

# Barrington Miscellaneous

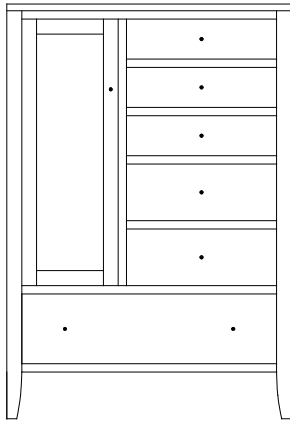

Option:  
Mirror on  
back of door

**BR-1352 Chifferobe**  
42<sup>3</sup>/<sub>4</sub>"w 62<sup>1</sup>/<sub>4</sub>"h 20<sup>1</sup>/<sub>2</sub>"d  
w/6 drawers, 1 door, 2 adj. shelves

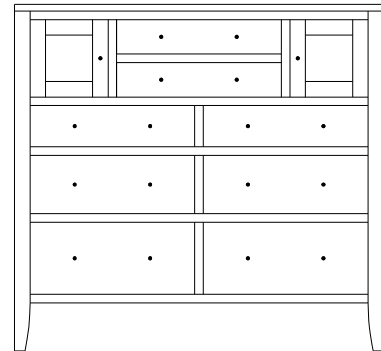

**BR-1353 His & Hers**  
55<sup>3</sup>/<sub>4</sub>"w 50<sup>1</sup>/<sub>2</sub>"h 20<sup>1</sup>/<sub>2</sub>"d  
w/8 drawers, 2 doors

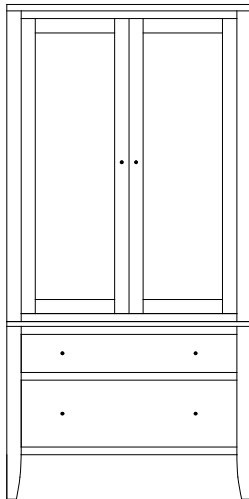

**BR-1362 Armoire**  
38<sup>1</sup>/<sub>2</sub>"w 78"h 20<sup>1</sup>/<sub>2</sub>"d  
w/2 drawers, (top drawer w/divider)  
w/2 doors, 2 adj. shelves & closet rod

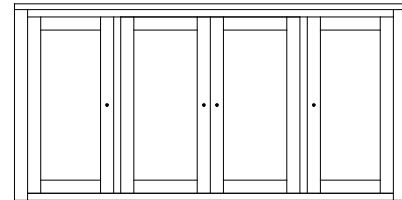

**BR-1359 Mule Chest Top**  
67<sup>1</sup>/<sub>4</sub>"w 33<sup>1</sup>/<sub>4</sub>"h 20<sup>1</sup>/<sub>2</sub>"d  
w/4 doors & 6 adjustable shelves

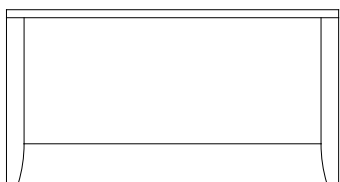

**BR-1339 Blanket Chest**  
41"w 22"h 21"d

Available  
with aromatic  
cedar bottom

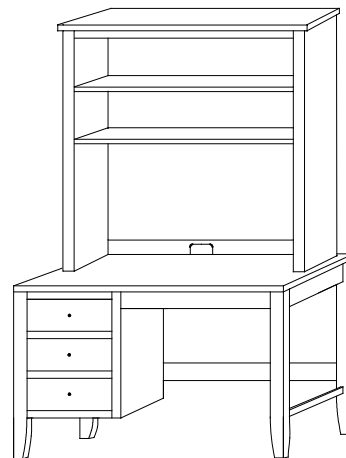

**BR-1397 Study Carrel**  
48"w 42"h 13"d  
w/2 adjustable shelves

**BR-1399 Student Desk**  
46"w 29<sup>1</sup>/<sub>2</sub>"h 21<sup>1</sup>/<sub>2</sub>"d  
w/3 drawers  
w/1 pencil drawer

Upgrades available on student desk:

Keyboard slideout instead of pencil drawer  
File drawer instead of bottom 2 drawers

# Barrington Dressers



**BR-1354 Dresser** shown with **MI-1630 Mirror**

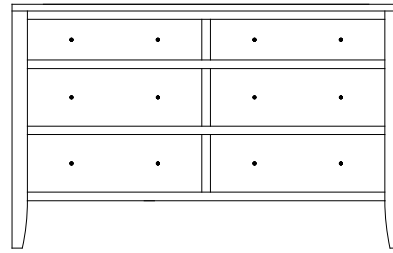

**BR-1354 Dresser**  
57¼"w 36"h 20½"d  
w/6 drawers

Suggested Mirrors:

**MI-1630 Mirror**  
40"h 36"w

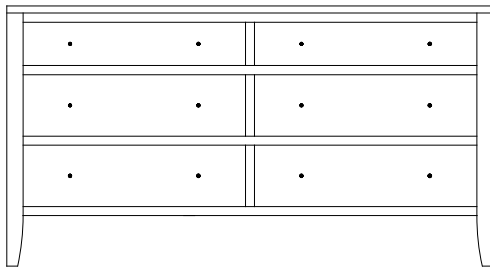

**BR-1355 Dresser**  
67¼"w 36"h 20½"d  
w/6 drawers

Suggested Mirrors:

**MI-1631 Mirror**  
40"h 46"w

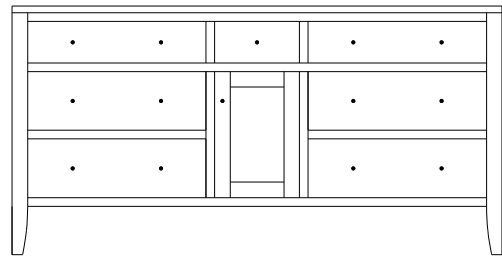

**BR-1356 Dresser**  
70¾"w 36"h 20½"d  
w/7 drawers, 1 door  
w/1 adjustable shelf

Suggested Mirrors:

**MI-1631 Mirror**  
40"h 46"w

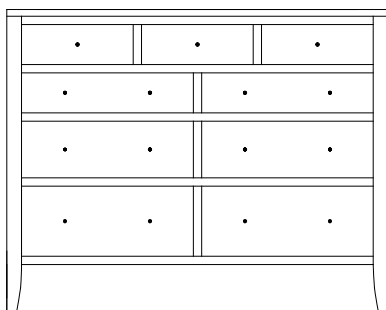

**BR-1357 Dresser**  
57¼"w 45¼"h 20½"d  
w/9 drawers

Suggested Mirrors:

**MI-1632 Mirror**  
32"h 42"w

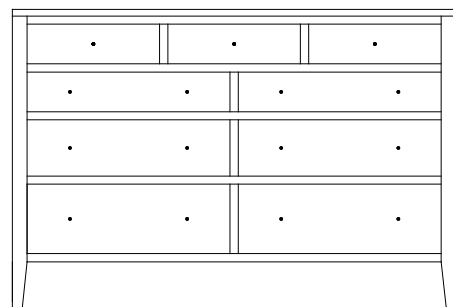

**BR-1358 Dresser**  
67¼"w 45¼"h 20½"d  
w/9 drawers

Suggested Mirrors:

**MI-1633 Mirror**  
32"h 52"w

# Barrington Dressers

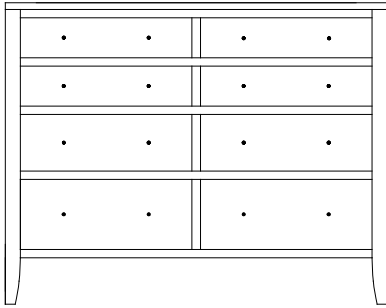

**BR-1360 Dresser**  
57¼"w 45¼"h 20½"d  
w/8 drawers

Suggested Mirrors:

**MI-1632 Mirror**  
32"h 42"w

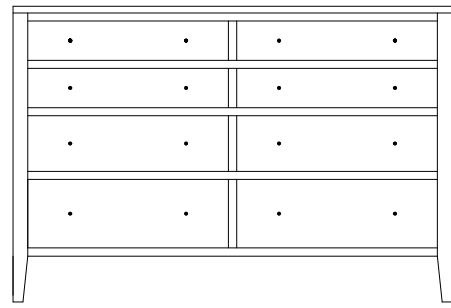

**BR-1361 Dresser**  
67¼"w 45¼"h 20½"d  
w/8 drawers

Suggested Mirrors:

**MI-1633 Mirror**  
32"h 52"w

# Barrington Mirrors



Beveled Mirror

**MI-1630 Mirror**  
40"high 36"wide

**MI-1631 Mirror**  
40"high 46"wide

**MI-1632 Mirror**  
32"high 42"wide

**MI-1633 Mirror**  
32"high 52"wide

# Barrington Bed Frames



Shown with Low Footboard



234-SR Storage Upgrade

Shown with Low Footboard

## Barrington Bed w/Wood Panels

Available with underbed storage options.

### Regular Footboard

<b>BR-1414-K</b> (King) 78 $\frac{3}{8}$ "w 84 $\frac{1}{2}$ "l HB 54"h ■ FB 30"h	<b>BR-1414-Q</b> (Queen) 63 $\frac{1}{8}$ "w 84 $\frac{1}{2}$ "l HB 54"h ■ FB 30"h
<b>BR-1414-F</b> (Full) 55 $\frac{7}{8}$ "w 79 $\frac{1}{2}$ "l HB 54"h ■ FB 30"h	<b>BR-1414-T</b> (Twin) 41"w 79 $\frac{1}{2}$ "l HB 54"h ■ FB 30"h

### Low Footboard

<b>BR-1422-K</b> (King) 78 $\frac{3}{8}$ "w 84 $\frac{1}{2}$ "l HB 54"h ■ FB 14 $\frac{3}{4}$ "h	<b>BR-1422-Q</b> (Queen) 63 $\frac{1}{8}$ "w 84 $\frac{1}{2}$ "l HB 54"h ■ FB 14 $\frac{3}{4}$ "h
<b>BR-1422-F</b> (Full) 55 $\frac{7}{8}$ "w 79 $\frac{1}{2}$ "l HB 54"h ■ FB 14 $\frac{3}{4}$ "h	<b>BR-1422-T</b> (Twin) 41"w 79 $\frac{1}{2}$ "l HB 54"h ■ FB 14 $\frac{3}{4}$ "h

### Headboard Only

<b>BR-1430K-HB</b> (King) 54" high	<b>BR-1430Q-HB</b> (Queen) 54" high
<b>BR-1430F-HB</b> (Full) 54" high	<b>BR-1430T-HB</b> (Twin) 54" high

## Elk Ridge Sleigh Bed

Available with underbed storage options.

### Regular Footboard

<b>ER-1930-K</b> (King) 79 $\frac{3}{8}$ "w 93"l HB 59"h ■ FB 30"h	<b>ER-1930-Q</b> (Queen) 64"w 93"l HB 59"h ■ FB 30"h
<b>ER-1930-F</b> (Full) 56 $\frac{7}{8}$ "w 88"l HB 59"h ■ FB 30"h	<b>ER-1930-T</b> (Twin) 42"w 88"l HB 59"h ■ FB 30"h

### Low Footboard

<b>ER-1932-K</b> (King) 79 $\frac{3}{8}$ "w 88 $\frac{3}{4}$ "l HB 59"h ■ FB 14 $\frac{3}{4}$ "h	<b>ER-1932-Q</b> (Queen) 64"w 88 $\frac{3}{4}$ "l HB 59"h ■ FB 14 $\frac{3}{4}$ "h
<b>ER-1932-F</b> (Full) 56 $\frac{7}{8}$ "w 83 $\frac{3}{4}$ "l HB 59"h ■ FB 14 $\frac{3}{4}$ "h	<b>ER-1932-T</b> (Twin) 42"w 83 $\frac{3}{4}$ "l HB 59"h ■ FB 14 $\frac{3}{4}$ "h

### Headboard Only

<b>ER-1940K-HB</b> (King) 59" high	<b>ER-1940Q-HB</b> (Queen) 59" high
<b>ER-1940F-HB</b> (Full) 59" high	<b>ER-1940T-HB</b> (Twin) 59" high

# Barrington Storage Rail Upgrades

## 12<sup>3</sup>/<sub>4</sub>" From Floor to Box Spring

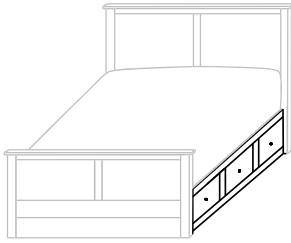

- With 3 drawers on each side
- 12<sup>3</sup>/<sub>4</sub>" from floor to Box Spring
- Inside drawer dimensions on all sizes  
9<sup>1</sup>/<sub>4</sub>"h 18<sup>7</sup>/<sub>8</sub>"w 22<sup>1</sup>/<sub>2</sub>"d

**532-SR-K** King – 6 drawers  
**532-SR-Q** Queen – 6 drawers  
**532-SR-F** Full – 6 drawers  
**532-SR-T** Twin – 3 drawers

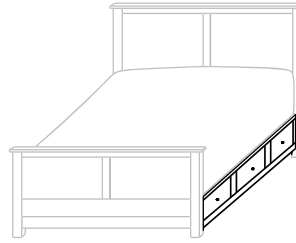

- With 3" Toe Kick
- With 3 drawers on each side
- 12<sup>3</sup>/<sub>4</sub>" from floor to Box Spring
- Inside drawer dimensions on all sizes  
6<sup>1</sup>/<sub>4</sub>"h 18<sup>7</sup>/<sub>8</sub>"w 22<sup>1</sup>/<sub>2</sub>"d

**234-SR-K** King – 6 drawers  
**234-SR-Q** Queen – 6 drawers  
**234-SR-F** Full – 6 drawers  
**234-SR-T** Twin – 3 drawers

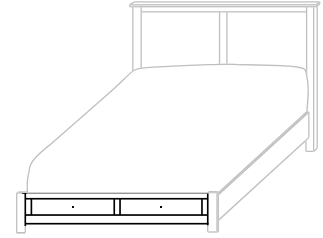

- 12<sup>3</sup>/<sub>4</sub>" from floor to Box Spring
- Inside drawer dimensions  
6<sup>1</sup>/<sub>4</sub>"h 22<sup>1</sup>/<sub>2</sub>"d  
 (King) 31"w      (Queen) 23<sup>1</sup>/<sub>4</sub>"w  
 (Full) 19<sup>5</sup>/<sub>8</sub>"w      (Twin) 29<sup>1</sup>/<sub>4</sub>"w

**685-FDS-K** King – 2 drawers  
**685-FDS-Q** Queen – 2 drawers  
**685-FDS-F** Full – 2 drawers  
**685-FDS-T** Twin – 1 drawer

## 19<sup>3</sup>/<sub>4</sub>" From Floor to Box Spring

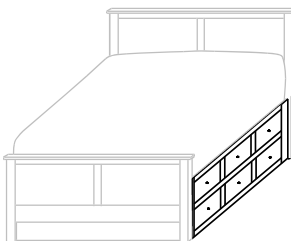

- With 6 drawers on each side
- Twin has 6 drawers on 1 side only
- 19<sup>3</sup>/<sub>4</sub>" from floor to Box Spring
- Inside drawer dimensions on all sizes  
6<sup>1</sup>/<sub>4</sub>"h 18<sup>7</sup>/<sub>8</sub>"w 22<sup>1</sup>/<sub>2</sub>"d

**654-SR-K** King – 12 drawers  
**654-SR-Q** Queen – 12 drawers  
**654-SR-F** Full – 12 drawers  
**654-SR-T** Twin – 6 drawers

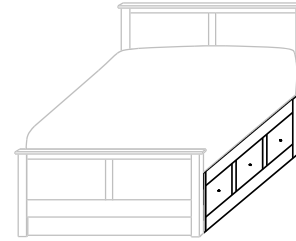

- With 3 drawers on each side
- 19<sup>3</sup>/<sub>4</sub>" from floor to Box Spring
- Inside drawer dimensions on all sizes  
10<sup>1</sup>/<sub>4</sub>"h 18<sup>7</sup>/<sub>8</sub>"w 22<sup>1</sup>/<sub>2</sub>"d

**325-SR-K** King – 6 drawers  
**325-SR-Q** Queen – 6 drawers  
**325-SR-F** Full – 6 drawers  
**325-SR-T** Twin – 3 drawers

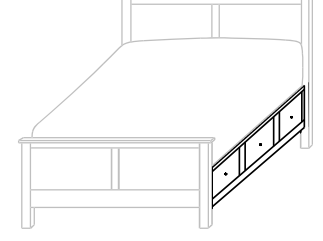

- With 7" Toe Kick
- With 3 drawers on each side
- 19<sup>3</sup>/<sub>4</sub>" from floor to Box Spring
- Inside drawer dimensions on all sizes  
9<sup>1</sup>/<sub>4</sub>"h 18<sup>7</sup>/<sub>8</sub>"w 22<sup>1</sup>/<sub>2</sub>"d

**236-SR-K** King – 6 drawers  
**236-SR-Q** Queen – 6 drawers  
**236-SR-F** Full – 6 drawers  
**236-SR-T** Twin – 3 drawers

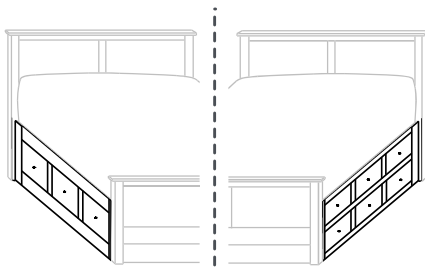

- With 3 drawers on one side and 6 drawers on other side
- 19<sup>3</sup>/<sub>4</sub>" from floor to Box Spring

**420-SR-K** King – 9 drawers  
**420-SR-Q** Queen – 9 drawers  
**420-SR-F** Full – 9 drawers  
 (Twin Not Available)

### Additional Upgrades

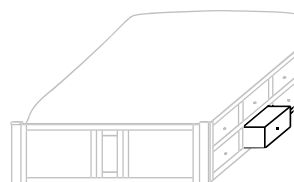

- With Step Stool Pullout in place of drawer

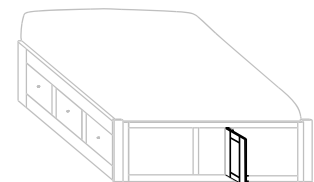

- With Door in Footboard to access area between rails





*Brookstone*  
Bedroom Collection

# Brookstone



## Brookstone Bedroom Collection

- BK-2865Q Queen Bed
- BK-2842 Night Stand
- BK-2850 Chest
- BK-2858 Dresser
- MI-2833 Mirror

Shown above in **QWO** with **OCS-113 Michael's KR15 Black Hardware w/ Optional Black Rope & Base Trim**

### Standard Features:



K810-MB Knobs



Standard with side-mount drawer slides



Stained poplar dovetailed drawers



Dovetailed bed slats

### Available Upgrades:

- Any hardware on our Hardware Options Sheet
- Black Rope & Base Trim
- Undermount soft close slides [See Price List]



- BK-2865Q Queen Bed
- BK-2842 Night Stand
- BK-2850 Chest
- BK-2858 Dresser
- MI-2833 Mirror

Shown in **Rustic QWO** with **OCS-136 Graystone** and **K810-MB Hardware**

# Brookstone Night Stands



**BK-2842**  
Night Stand shown



Sliding top option available on all night stands  
(Hidden compartment w/Lock)

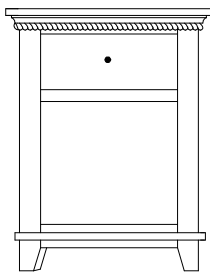

**BK-2840 Night Stand**  
21 $\frac{3}{4}$ "w 28 $\frac{1}{4}$ "h 17 $\frac{3}{4}$ "d  
w/1 drawer

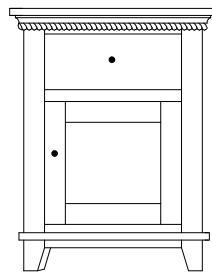

**BK-2841 Night Stand**  
21 $\frac{3}{4}$ "w 28 $\frac{1}{4}$ "h 17 $\frac{3}{4}$ "d  
w/1 drawer, 1 door

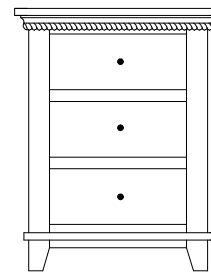

**BK-2842 Night Stand**  
21 $\frac{3}{4}$ "w 28 $\frac{1}{4}$ "h 17 $\frac{3}{4}$ "d  
w/3 drawers

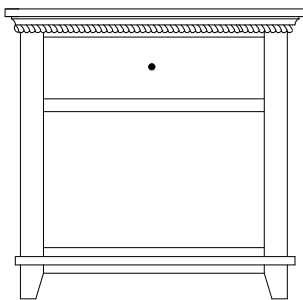

**BK-2843 Night Stand**  
28 $\frac{1}{2}$ "w 28 $\frac{1}{4}$ "h 17 $\frac{3}{4}$ "d  
w/1 drawer

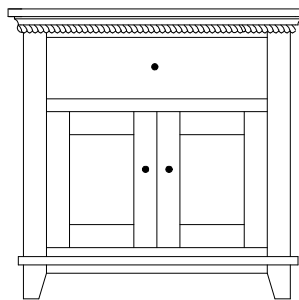

**BK-2844 Night Stand**  
28 $\frac{1}{2}$ "w 28 $\frac{1}{4}$ "h 17 $\frac{3}{4}$ "d  
w/1 drawer, 2 doors

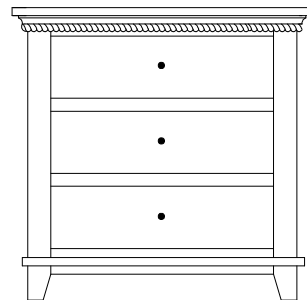

**BK-2845 Night Stand**  
28 $\frac{1}{2}$ "w 28 $\frac{1}{4}$ "h 17 $\frac{3}{4}$ "d  
w/3 drawers

# Brookstone Lingeries & Chests



**BK-2850**  
Chest shown

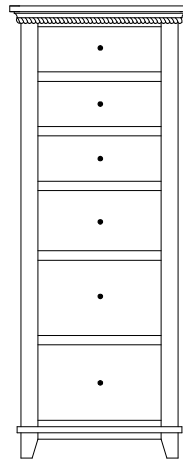

**BK-2846 Lingerie**  
23 $\frac{3}{8}$ "w 60"h 21 $\frac{3}{4}$ "d  
w/6 drawers

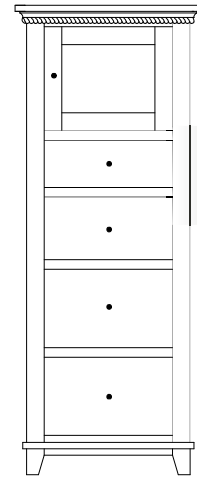

Available with  
mirror in  
door panel

**BK-2847 Lingerie**  
23 $\frac{3}{8}$ "w 60"h 21 $\frac{3}{4}$ "d  
w/4 drawers, 1 wood door,  
1 adjustable shelf

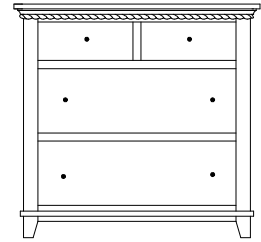

**BK-2849 Chest**  
37 $\frac{3}{4}$ "w 36 $\frac{1}{4}$ "h 21 $\frac{3}{4}$ "d  
w/4 drawers

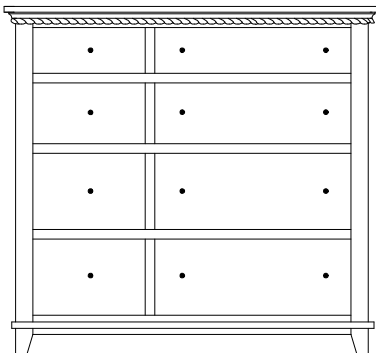

**BK-2848 Chest**  
48 $\frac{3}{4}$ "w 45 $\frac{1}{2}$ "h 21 $\frac{3}{4}$ "d  
w/8 drawers

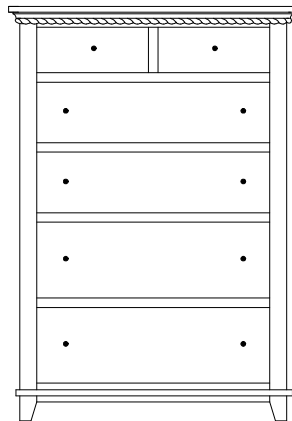

**BK-2850 Chest**  
37 $\frac{3}{4}$ "w 54 $\frac{3}{4}$ "h 21 $\frac{3}{4}$ "d  
w/6 drawers

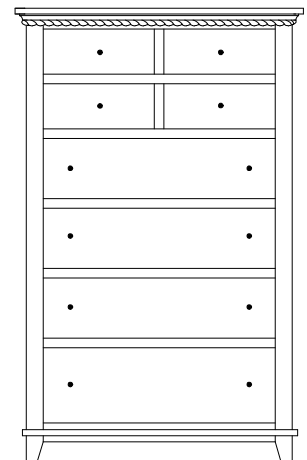

**BK-2851 Hi-Boy**  
37 $\frac{3}{4}$ "w 60"h 21 $\frac{3}{4}$ "d  
w/8 drawers

# Brookstone Miscellaneous

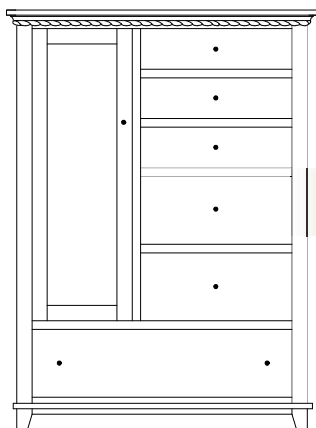

Option:  
Mirror on  
back of door

**BK-2852 Chifferobe**  
45¼"w 62"h 21¾"d  
w/6 drawers, 1 door, 2 adj. shelves

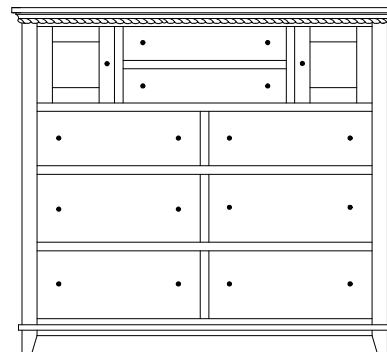

**BK-2853 His & Hers Chest**  
56¼"w 50¾"h 21¾"d  
w/8 drawers, 2 doors

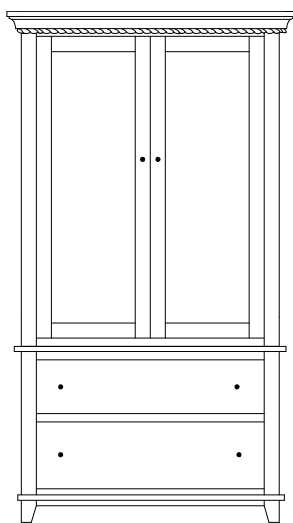

**BK-2862 Armoire**  
42"w 76¼"h 22¼"d  
w/2 drawers, w/2 doors,  
2 adj. shelves & closet rod

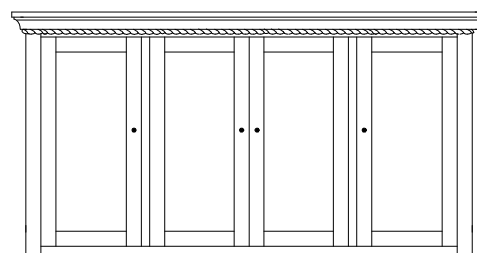

**BK-2859 Mule Chest Top**  
70¾"w 36½"h 22¼"d  
w/4 doors & 6 adjustable shelves

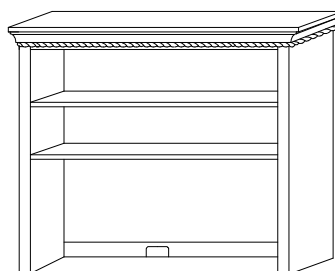

**BK-2897 Study Carrel**  
49½"w 42"h 13¾"d  
w/2 adjustable shelves

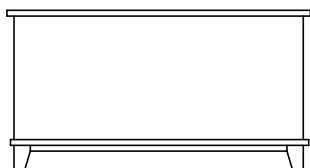

**BK-2835 Blanket Chest**  
42"w 22"h 21½"d

Available  
with aromatic  
cedar bottom



**BK-2899 Student Desk**  
48"w 29"h 23"d  
w/3 drawers  
w/1 pencil drawer

Upgrades available on student desk:

Keyboard slideout instead of pencil drawer  
File drawer instead of bottom 2 drawers

# Brookstone Dressers



**BK-2858** Dresser shown with **MI-2833** Mirror

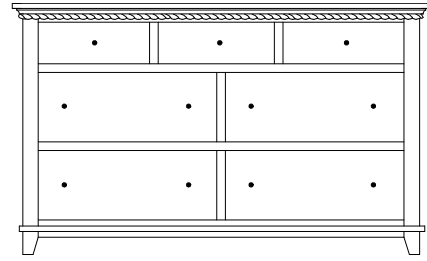

**BK-2854** Dresser  
59 $\frac{3}{4}$ "w 36 $\frac{1}{4}$ "h 21 $\frac{3}{4}$ "d  
w/7 drawers

Suggested Mirrors:

**MI-2830** Mirror  
40"h 37"w

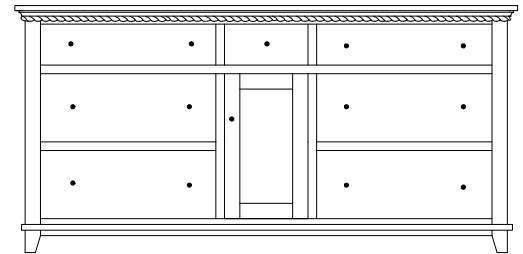

**BK-2856** Dresser  
73 $\frac{1}{4}$ "w 36 $\frac{1}{4}$ "h 21 $\frac{3}{4}$ "d  
w/7 drawers, 1 door  
w/1 adjustable shelf

Suggested Mirrors:

**MI-2831** Mirror  
40"h 47"w

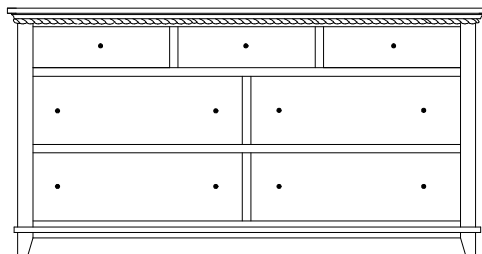

**BK-2855** Dresser  
69 $\frac{3}{4}$ "w 36 $\frac{1}{4}$ "h 21 $\frac{3}{4}$ "d  
w/7 drawers

Suggested Mirrors:

**MI-2831** Mirror  
40"h 47"w

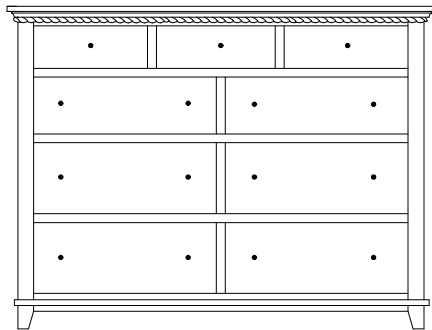

**BK-2857** Dresser  
59 $\frac{3}{4}$ "w 45 $\frac{1}{2}$ "h 21 $\frac{3}{4}$ "d  
w/9 drawers

Suggested Mirrors:

**MI-2832** Mirror  
32"h 43"w

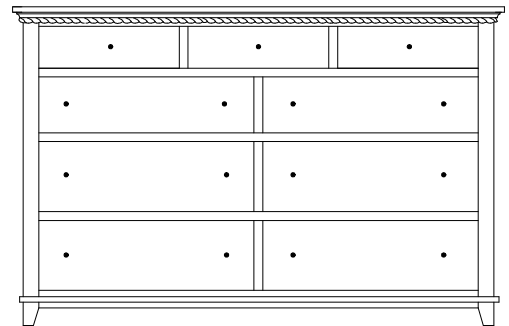

**BK-2858** Dresser  
69 $\frac{3}{4}$ "w 45 $\frac{1}{2}$ "h 21 $\frac{3}{4}$ "d  
w/9 drawers

Suggested Mirrors:

**MI-2833** Mirror  
32"h 53"w

# Brookstone Mirrors

---



**MI-2830 Mirror**  
40"h 37"w

**MI-2831 Mirror**  
40"h 47"w

**MI-2832 Mirror**  
32"h 43"w

**MI-2833 Mirror**  
32"h 53"w

Beveled Mirror

# Brookstone Bed Frames



shown with Regular Footboard

## Brookstone Bed

### Regular Footboard

Available  
with underbed  
storage options.

**BK-2865-K (King)**  
82<sup>5</sup>/<sub>8</sub>"w 89"l  
HB 55<sup>1</sup>/<sub>4</sub>"h ■ FB 34"h

**BK-2865-Q (Queen)**  
67"w 89"l  
HB 55<sup>1</sup>/<sub>4</sub>"h ■ FB 34"h

**BK-2865-F (Full)**  
59<sup>7</sup>/<sub>8</sub>"w 84"l  
HB 55<sup>1</sup>/<sub>4</sub>"h ■ FB 34"h

**BK-2865-T (Twin)**  
45"w 84"l  
HB 55<sup>1</sup>/<sub>4</sub>"h ■ FB 34"h

### Low Footboard

**BK-2866-K (King)**  
82<sup>5</sup>/<sub>8</sub>"w 87<sup>1</sup>/<sub>4</sub>"l  
HB 55<sup>1</sup>/<sub>4</sub>"h ■ FB 14<sup>3</sup>/<sub>4</sub>"h

**BK-2866-Q (Queen)**  
67"w 87<sup>1</sup>/<sub>4</sub>"l  
HB 55<sup>1</sup>/<sub>4</sub>"h ■ FB 14<sup>3</sup>/<sub>4</sub>"h

**BK-2866-F (Full)**  
59<sup>7</sup>/<sub>8</sub>"w 82<sup>1</sup>/<sub>4</sub>"l  
HB 55<sup>1</sup>/<sub>4</sub>"h ■ FB 14<sup>3</sup>/<sub>4</sub>"h

**BK-2866-T (Twin)**  
45"w 82<sup>1</sup>/<sub>4</sub>"l  
HB 55<sup>1</sup>/<sub>4</sub>"h ■ FB 14<sup>3</sup>/<sub>4</sub>"h

### Headboard Only

**BK-2867K-HB (King)**  
55<sup>1</sup>/<sub>4</sub>" high

**BK-2867Q-HB (Queen)**  
55<sup>1</sup>/<sub>4</sub>" high

**BK-2867F-HB (Full)**  
55<sup>1</sup>/<sub>4</sub>" high

**BK-2867T-HB (Twin)**  
48" high

# Brookstone Storage Rail Upgrades

## 12<sup>3</sup>/<sub>4</sub>" From Floor to Box Spring

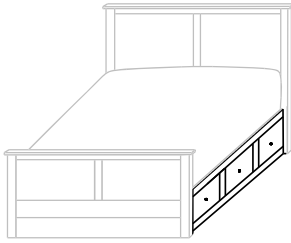

- With 3 drawers on each side
- 12<sup>3</sup>/<sub>4</sub>" from floor to Box Spring
- Inside drawer dimensions on all sizes  
9<sup>1</sup>/<sub>4</sub>"h 18<sup>7</sup>/<sub>8</sub>"w 22<sup>1</sup>/<sub>2</sub>"d

**532-SR-K** King – 6 drawers  
**532-SR-Q** Queen – 6 drawers  
**532-SR-F** Full – 6 drawers  
**532-SR-T** Twin – 3 drawers

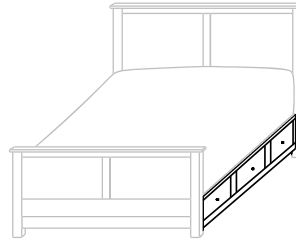

- With 3" Toe Kick
- With 3 drawers on each side
- 12<sup>3</sup>/<sub>4</sub>" from floor to Box Spring
- Inside drawer dimensions on all sizes  
6<sup>1</sup>/<sub>4</sub>"h 18<sup>7</sup>/<sub>8</sub>"w 22<sup>1</sup>/<sub>2</sub>"d

**234-SR-K** King – 6 drawers  
**234-SR-Q** Queen – 6 drawers  
**234-SR-F** Full – 6 drawers  
**234-SR-T** Twin – 3 drawers

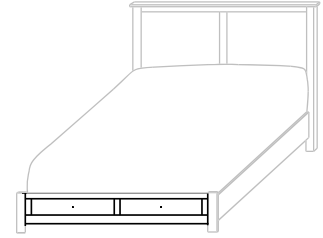

- 12<sup>3</sup>/<sub>4</sub>" from floor to Box Spring
- Inside drawer dimensions  
6<sup>1</sup>/<sub>4</sub>"h 22<sup>1</sup>/<sub>2</sub>"d  
 (King) 31"w      (Queen) 23<sup>1</sup>/<sub>4</sub>"w  
 (Full) 19<sup>5</sup>/<sub>8</sub>"w      (Twin) 29<sup>1</sup>/<sub>4</sub>"w

**685-FDS-K** King – 2 drawers  
**685-FDS-Q** Queen – 2 drawers  
**685-FDS-F** Full – 2 drawers  
**685-FDS-T** Twin – 1 drawer

## 19<sup>3</sup>/<sub>4</sub>" From Floor to Box Spring

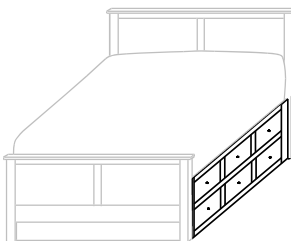

- With 6 drawers on each side
- Twin has 6 drawers on 1 side only
- 19<sup>3</sup>/<sub>4</sub>" from floor to Box Spring
- Inside drawer dimensions on all sizes  
6<sup>1</sup>/<sub>4</sub>"h 18<sup>7</sup>/<sub>8</sub>"w 22<sup>1</sup>/<sub>2</sub>"d

**654-SR-K** King – 12 drawers  
**654-SR-Q** Queen – 12 drawers  
**654-SR-F** Full – 12 drawers  
**654-SR-T** Twin – 6 drawers

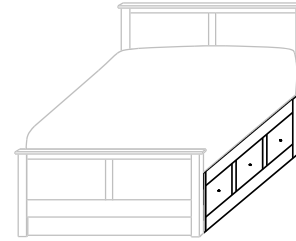

- With 3 drawers on each side
- 19<sup>3</sup>/<sub>4</sub>" from floor to Box Spring
- Inside drawer dimensions on all sizes  
10<sup>1</sup>/<sub>4</sub>"h 18<sup>7</sup>/<sub>8</sub>"w 22<sup>1</sup>/<sub>2</sub>"d

**325-SR-K** King – 6 drawers  
**325-SR-Q** Queen – 6 drawers  
**325-SR-F** Full – 6 drawers  
**325-SR-T** Twin – 3 drawers

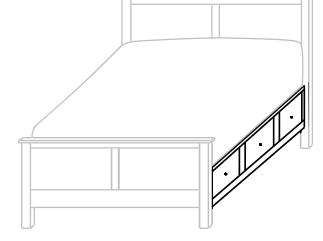

- With 7" Toe Kick
- With 3 drawers on each side
- 19<sup>3</sup>/<sub>4</sub>" from floor to Box Spring
- Inside drawer dimensions on all sizes  
9<sup>1</sup>/<sub>4</sub>"h 18<sup>7</sup>/<sub>8</sub>"w 22<sup>1</sup>/<sub>2</sub>"d

**236-SR-K** King – 6 drawers  
**236-SR-Q** Queen – 6 drawers  
**236-SR-F** Full – 6 drawers  
**236-SR-T** Twin – 3 drawers

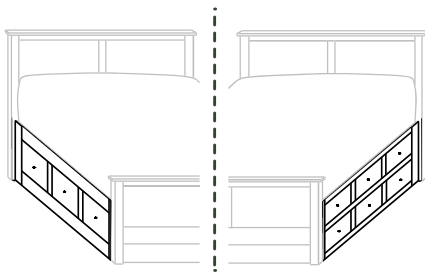

- With 3 drawers on one side and 6 drawers on other side
- 19<sup>3</sup>/<sub>4</sub>" from floor to Box Spring

**420-SR-K** King – 9 drawers  
**420-SR-Q** Queen – 9 drawers  
**420-SR-F** Full – 9 drawers  
 (Twin Not Available)

### Additional Upgrades

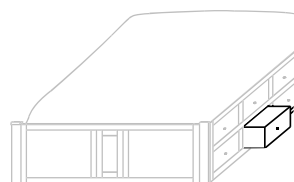

- With Step Stool Pullout in place of drawer

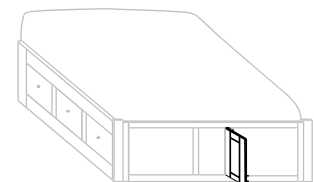

- With Door in Footboard to access area between rails





*Cabin Creek*  
Bedroom Collection

# Cabin Creek



## Cabin Creek Bedroom Collection w/Dreamland Bed

- PI-1124Q Prairie Bed w/685-FDS Storage Upgrade
- CA-542 Night Stand
- CA-551 Chest
- CA-558 Dresser
- MI-1733 Mirror

Shown above in **Brown Maple** with **OCS-117 Asbury** and **K3489-SN Hardware**

### Standard Features:



1 1/2" Wood Knobs



Standard with side-mount drawer slides

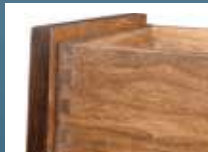

Stained poplar drawer boxes



Dovetailed bed slats



- CA-564Q Queen Bed
- CA-542 Night Stand
- CA-551 Hi-Boy
- CA-558 Dresser
- MI-1733 Mirror

Shown in **Brown Maple** with **FC-47874 Stockton** and **K558-SI Hardware**

### Available Upgrades:

- Any hardware on our Hardware Options Sheet
- Undermount soft close slides [See Price List]
- Rough sawn tops [See Price List]

# Cabin Creek Night Stands



**CA-542**  
Night Stand shown



Sliding top option available on all night stands  
(Hidden compartment w/Lock)

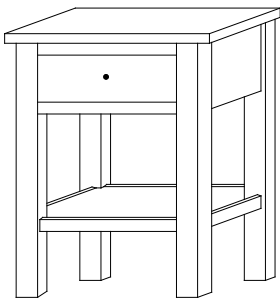

**CA-540 Night Stand**  
21¼"w 28"h 18½"d  
w/1 drawer

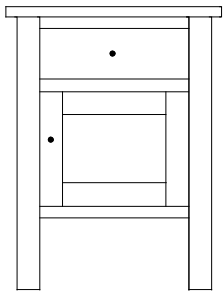

**CA-541 Night Stand**  
21¼"w 28"h 17½"d  
w/1 drawer, 1 door

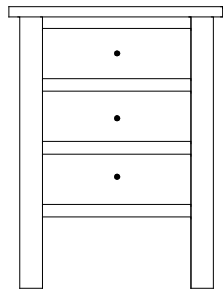

**CA-542 Night Stand**  
21¼"w 28"h 17½"d  
w/3 drawers

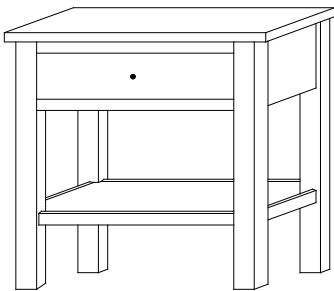

**CA-543 Night Stand**  
28"w 28"h 18½"d  
w/1 drawer

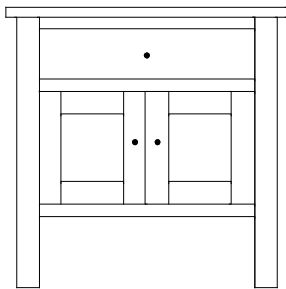

**CA-544 Night Stand**  
28"w 28"h 17½"d  
w/1 drawer, 2 doors

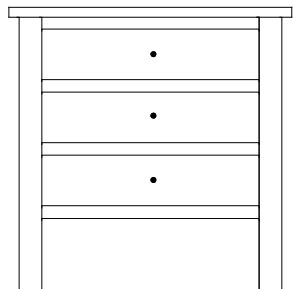

**CA-545 Night Stand**  
28"w 28"h 17½"d  
w/3 drawers

# Cabin Creek Lingeries & Chests



**CA-551**  
Hi-Boy shown

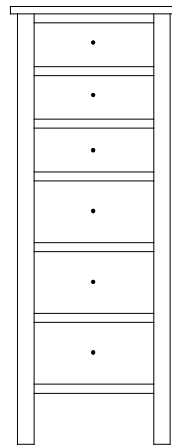

**CA-546 Lingerie**  
23"w 60¼"h 21½"d  
w/6 drawers

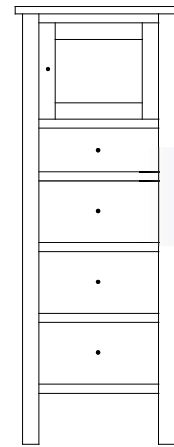

Available with  
mirror panel  
in door (CA-548)

**CA-547 Lingerie**  
23"w 60¼"h 21½"d  
w/4 drawers, 1 wood door,  
1 adjustable shelf

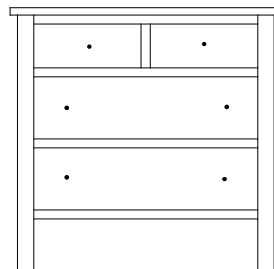

**CA-549 Chest**  
37¼"w 36"h 21½"d  
w/4 drawers

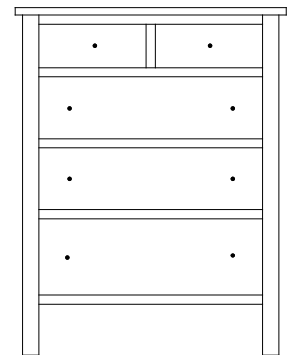

**CA-550 Chest**  
37¼"w 47¾"h 21½"d  
w/5 drawers

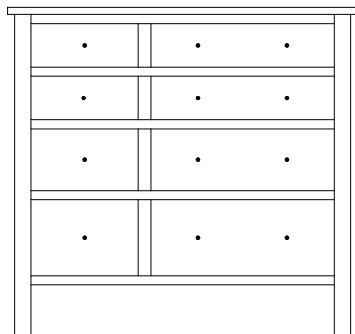

**CA-557 Chest**  
48¼"w 45¼"h 21½"d  
w/8 drawers

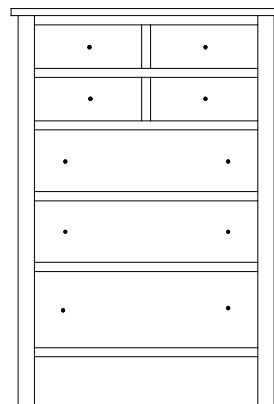

**CA-551 Hi-Boy**  
37¼"w 55"h 21½"d  
w/7 drawers

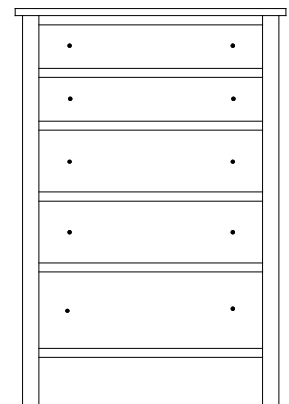

**CA-561 Hi-Boy**  
37¼"w 55"h 21½"d  
w/5 drawers

# Cabin Creek Miscellaneous

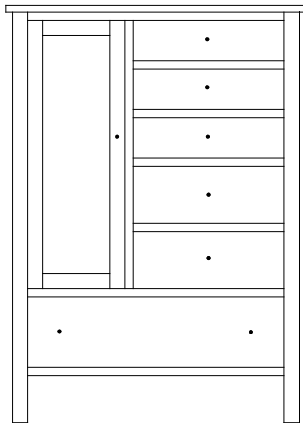

Option:  
Mirror on  
back of door

**CA-552 Chifferobe**  
44<sup>3</sup>/<sub>4</sub>"w 62<sup>1</sup>/<sub>4</sub>"h 21<sup>1</sup>/<sub>2</sub>"d  
w/6 drawers, 1 door, 2 adjustable shelves

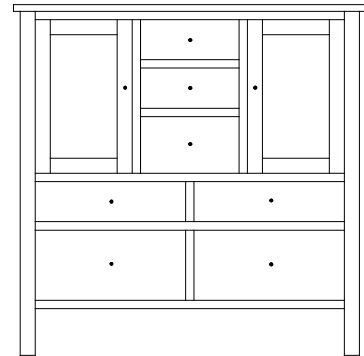

**CA-553 His & Hers**  
52<sup>3</sup>/<sub>4</sub>"w 52<sup>1</sup>/<sub>2</sub>"h 21<sup>1</sup>/<sub>2</sub>"d  
w/7 drawers, 2 doors, 2 adjustable shelves

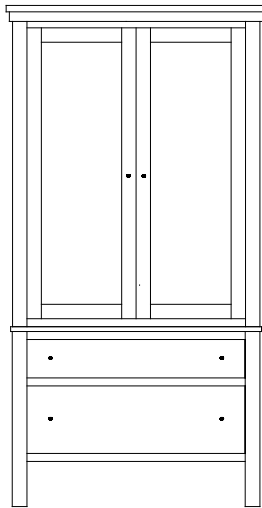

**CA-562 Armoire**  
40<sup>1</sup>/<sub>2</sub>"w 78"h 21<sup>1</sup>/<sub>2</sub>"d  
w/2 drawers, 2 doors,  
2 adjustable shelves, closet rod

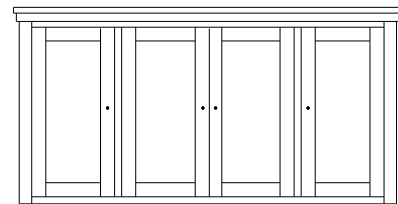

**CA-559 Mule Chest Top**  
69<sup>1</sup>/<sub>4</sub>"w 35"h 21<sup>1</sup>/<sub>2</sub>"d  
w/4 doors, 6 adjustable shelves

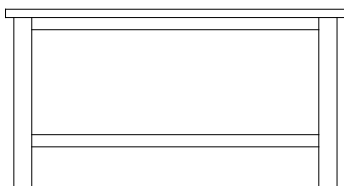

**CA-498 Blanket Chest**  
42"w 22"h 21<sup>1</sup>/<sub>2</sub>"d  
Available  
with aromatic  
cedar bottom

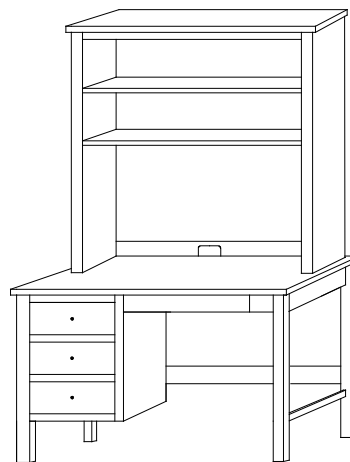

**CA-497 Study Carrel**  
48"w 42"h 13"d  
w/2 adjustable shelves

**CA-499 Student Desk**  
48"w 29<sup>1</sup>/<sub>2</sub>"h 22<sup>1</sup>/<sub>2</sub>"d  
w/3 drawers, 1 pencil drawer

Upgrades available on student desk:

Keyboard slideout instead of pencil drawer  
File drawer instead of bottom 2 drawers

# Cabin Creek Dressers



CA-558 Dresser shown with MI-1733 Mirror

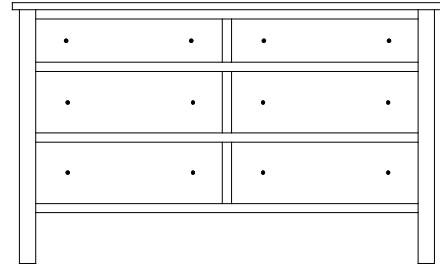

**CA-554 Dresser**  
59¼"w 36"h 21½"d  
w/6 drawers

Suggested Mirrors:

**MI-1730 Mirror**  
40"h 36"w

**MI-1830 Mirror**  
40"h 36"w

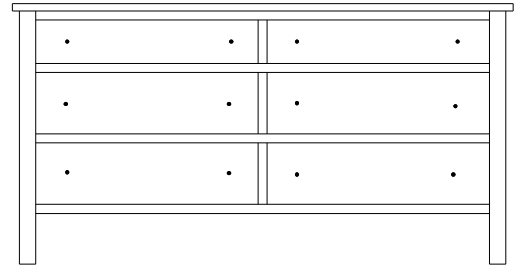

**CA-555 Dresser**  
69¼"w 36"h 21½"d  
w/6 drawers

Suggested Mirrors:

**MI-1731 Mirror**  
40"h 46"w

**MI-1831 Mirror**  
40"h 46"w

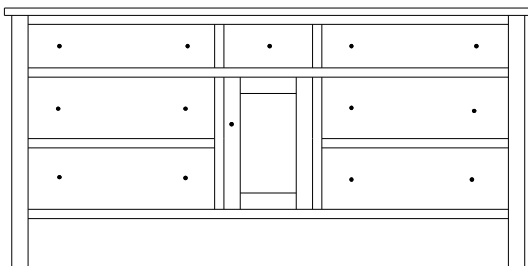

**CA-556 Dresser**  
72¾"w 36"h 21½"d  
w/7 drawers, 1 door,  
1 adjustable shelf

Suggested Mirrors:

**MI-1731 Mirror**  
40"h 46"w

**MI-1831 Mirror**  
40"h 46"w

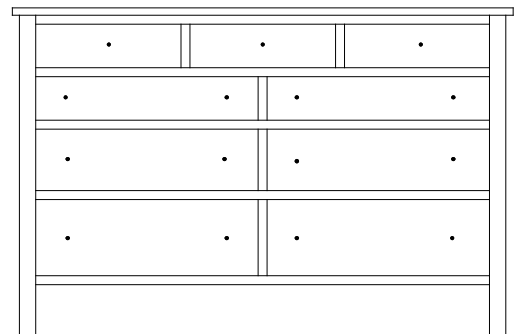

**CA-558 Dresser**  
69¼"w 45¼"h 21½"d  
w/9 drawers

Suggested Mirrors:

**MI-1733 Mirror**  
32"h 52"w

**MI-1833 Mirror**  
32"h 52"w

# Cabin Creek Mirrors

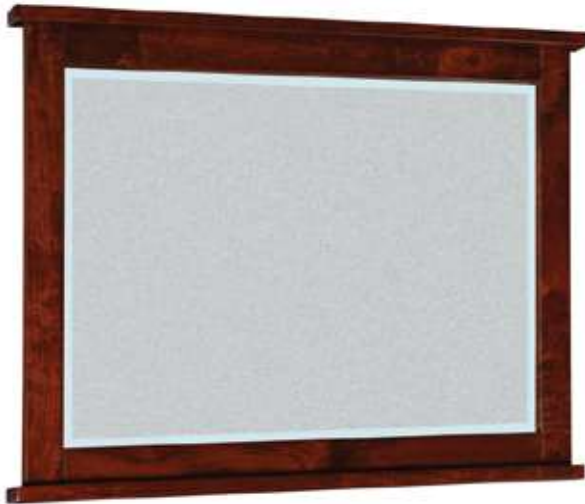

Beveled Mirror

**MI-1730 Mirror**  
40"high 36"wide

**MI-1731 Mirror**  
40"high 46"wide

**MI-1732 Mirror**  
32"high 42"wide

**MI-1733 Mirror**  
32"high 52"wide



Beveled Mirror

**MI-1830 Mirror**  
40"high 36"wide

**MI-1831 Mirror**  
40"high 46"wide

**MI-1832 Mirror**  
32"high 42"wide

**MI-1833 Mirror**  
32"high 52"wide

# Cabin Creek Bed Frames



shown with Regular Footboard



shown with Regular Footboard

## Prairie Bed

### Regular Footboard

Available with underbed storage options.

**PI-1122-K (King)**  
81 $\frac{5}{8}$ "w 84 $\frac{1}{2}$ "l  
HB 53"h ■ FB 30"h

**PI-1122-Q (Queen)**  
66"w 84 $\frac{1}{2}$ "l  
HB 53"h ■ FB 30"h

**PI-1122-F (Full)**  
58 $\frac{7}{8}$ "w 79 $\frac{1}{2}$ "l  
HB 53"h ■ FB 30"h

**PI-1122-T (Twin)**  
44"w 79 $\frac{1}{2}$ "l  
HB 53"h ■ FB 30"h

### Low Footboard

**PI-1124-K (King)**  
81 $\frac{5}{8}$ "w 84 $\frac{1}{2}$ "l  
HB 53"h ■ FB 14 $\frac{3}{4}$ "h

**PI-1124-Q (Queen)**  
66"w 84 $\frac{1}{2}$ "l  
HB 53"h ■ FB 14 $\frac{3}{4}$ "h

**PI-1124-F (Full)**  
58 $\frac{7}{8}$ "w 79 $\frac{1}{2}$ "l  
HB 53"h ■ FB 14 $\frac{3}{4}$ "h

**PI-1124-T (Twin)**  
44"w 79 $\frac{1}{2}$ "l  
HB 53"h ■ FB 14 $\frac{3}{4}$ "h

### Headboard Only

**PI-1126K-HB (King)**  
53" high

**PI-1126Q-HB (Queen)**  
53" high

**PI-1126F-HB (Full)**  
53" high

**PI-1126T-HB (Twin)**  
53" high

## Cabin Creek Bed

### Regular Footboard

Available with underbed storage options.

**CA-564-K (King)**  
82 $\frac{1}{8}$ "w 89 $\frac{1}{2}$ "l  
HB 49 $\frac{1}{4}$ "h ■ FB 21 $\frac{1}{4}$ "h

**CA-564-Q (Queen)**  
66 $\frac{5}{8}$ "w 89 $\frac{1}{2}$ "l  
HB 49 $\frac{1}{4}$ "h ■ FB 21 $\frac{1}{4}$ "h

**CA-564-F (Full)**  
59 $\frac{3}{8}$ "w 84 $\frac{1}{2}$ "l  
HB 49 $\frac{1}{4}$ "h ■ FB 21 $\frac{1}{4}$ "h

**CA-564-T (Twin)**  
44 $\frac{1}{2}$ "w 84 $\frac{1}{2}$ "l  
HB 49 $\frac{1}{4}$ "h ■ FB 21 $\frac{1}{4}$ "h

### Headboard Only

**CA-568K-HB (King)**  
49 $\frac{1}{4}$ " high

**CA-568Q-HB (Queen)**  
49 $\frac{1}{4}$ " high

**CA-568F-HB (Full)**  
49 $\frac{1}{4}$ " high

**CA-568T-HB (Twin)**  
49 $\frac{1}{4}$ " high

# Cabin Creek Storage Rail Upgrades

## 12<sup>3</sup>/<sub>4</sub>" From Floor to Box Spring

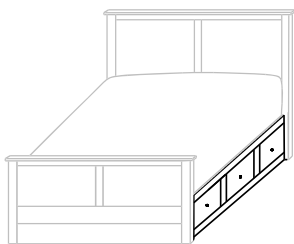

- With 3 drawers on each side
- 12<sup>3</sup>/<sub>4</sub>" from floor to Box Spring
- Inside drawer dimensions on all sizes  
9<sup>1</sup>/<sub>4</sub>"h 18<sup>7</sup>/<sub>8</sub>"w 22<sup>1</sup>/<sub>2</sub>"d

**532-SR-K** King – 6 drawers  
**532-SR-Q** Queen – 6 drawers  
**532-SR-F** Full – 6 drawers  
**532-SR-T** Twin – 3 drawers

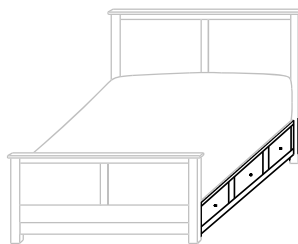

- With 3" Toe Kick
- With 3 drawers on each side
- 12<sup>3</sup>/<sub>4</sub>" from floor to Box Spring
- Inside drawer dimensions on all sizes  
6<sup>1</sup>/<sub>4</sub>"h 18<sup>7</sup>/<sub>8</sub>"w 22<sup>1</sup>/<sub>2</sub>"d

**234-SR-K** King – 6 drawers  
**234-SR-Q** Queen – 6 drawers  
**234-SR-F** Full – 6 drawers  
**234-SR-T** Twin – 3 drawers

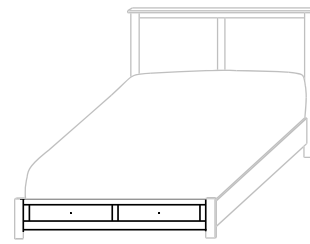

- 12<sup>3</sup>/<sub>4</sub>" from floor to Box Spring
- Inside drawer dimensions  
6<sup>1</sup>/<sub>4</sub>"h 22<sup>1</sup>/<sub>2</sub>"d  
 (King) 31"w      (Queen) 23<sup>1</sup>/<sub>4</sub>"w  
 (Full) 19<sup>5</sup>/<sub>8</sub>"w      (Twin) 29<sup>1</sup>/<sub>4</sub>"w

**685-FDS-K** King – 2 drawers  
**685-FDS-Q** Queen – 2 drawers  
**685-FDS-F** Full – 2 drawers  
**685-FDS-T** Twin – 1 drawer

## 19<sup>3</sup>/<sub>4</sub>" From Floor to Box Spring

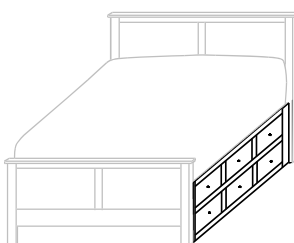

- With 6 drawers on each side
- Twin has 6 drawers on 1 side only
- 19<sup>3</sup>/<sub>4</sub>" from floor to Box Spring
- Inside drawer dimensions on all sizes  
6<sup>1</sup>/<sub>4</sub>"h 18<sup>7</sup>/<sub>8</sub>"w 22<sup>1</sup>/<sub>2</sub>"d

**654-SR-K** King – 12 drawers  
**654-SR-Q** Queen – 12 drawers  
**654-SR-F** Full – 12 drawers  
**654-SR-T** Twin – 6 drawers

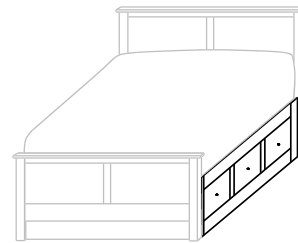

- With 3 drawers on each side
- 19<sup>3</sup>/<sub>4</sub>" from floor to Box Spring
- Inside drawer dimensions on all sizes  
10<sup>1</sup>/<sub>4</sub>"h 18<sup>7</sup>/<sub>8</sub>"w 22<sup>1</sup>/<sub>2</sub>"d

**325-SR-K** King – 6 drawers  
**325-SR-Q** Queen – 6 drawers  
**325-SR-F** Full – 6 drawers  
**325-SR-T** Twin – 3 drawers

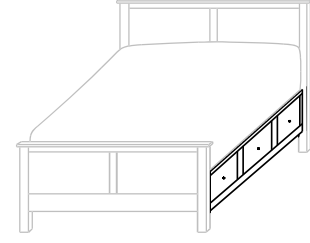

- With 7" Toe Kick
- With 3 drawers on each side
- 19<sup>3</sup>/<sub>4</sub>" from floor to Box Spring
- Inside drawer dimensions on all sizes  
9<sup>1</sup>/<sub>4</sub>"h 18<sup>7</sup>/<sub>8</sub>"w 22<sup>1</sup>/<sub>2</sub>"d

**236-SR-K** King – 6 drawers  
**236-SR-Q** Queen – 6 drawers  
**236-SR-F** Full – 6 drawers  
**236-SR-T** Twin – 3 drawers

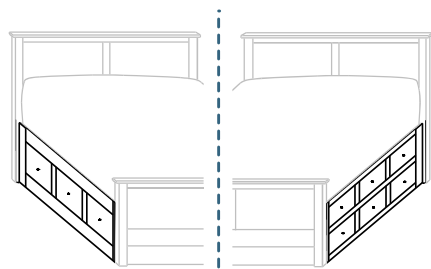

- With 3 drawers on one side and 6 drawers on other side
- 19<sup>3</sup>/<sub>4</sub>" from floor to Box Spring

**420-SR-K** King – 9 drawers  
**420-SR-Q** Queen – 9 drawers  
**420-SR-F** Full – 9 drawers  
 (Twin Not Available)

### Additional Upgrades

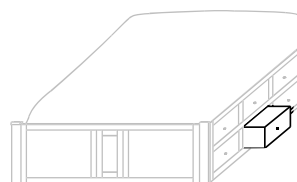

- With Step Stool Pullout in place of drawer

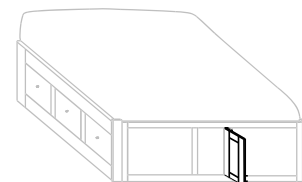

- With Door in Footboard to access area between rails





*Canyon Creek*  
Bedroom Collection

# Canyon Creek



## Canyon Creek Bedroom Collection

- CC-2565Q Queen Bed
- CC-2542 Night Stand
- CC-2550 Chest
- CC-2557 Dresser
- MI-2532 Mirror

Shown above in **Rustic QWO** with **OCS-113 Michael's** and **Optional Leather Accents** with **4425-WI Knobs** and **4424-WI Pulls**

### Standard Features:



4425-WI Knobs  
& 4424-WI Pulls



Standard with side-mount drawer slides



Stained poplar dovetailed drawers



Dovetailed bed slats

### Available Upgrades:

- Any hardware on our Hardware Options Sheet
- Leather Accent Panels in top drawers & bed [See Price List]
- Undermount soft close slides [See Price List]



- CC-2565Q Queen Bed
- CC-2545 Night Stand
- CC-2550 Chest
- CC-2558 Dresser
- MI-2533 Mirror

Shown in **Rustic QWO** with **OCS-122 Cocoa** and **Optional L555 Antique White Leather Accents** with **4425-WI Knobs** and **4424-WI Pulls**

# Canyon Creek Night Stands



**CC-2545**  
Night Stand shown



Sliding top option available on all night stands  
(Hidden compartment w/Lock)

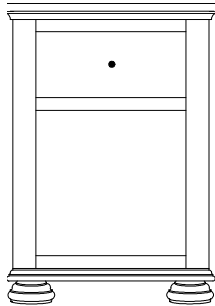

**CC-2540 Night Stand**  
21 $\frac{3}{4}$ "w 29 $\frac{1}{2}$ "h 17 $\frac{3}{4}$ "d  
w/1 drawer

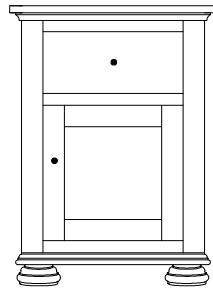

**CC-2541 Night Stand**  
21 $\frac{3}{4}$ "w 29 $\frac{1}{2}$ "h 17 $\frac{3}{4}$ "d  
w/1 drawer, 1 door

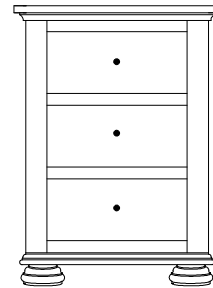

**CC-2542 Night Stand**  
21 $\frac{3}{4}$ "w 29 $\frac{1}{2}$ "h 17 $\frac{3}{4}$ "d  
w/3 drawers

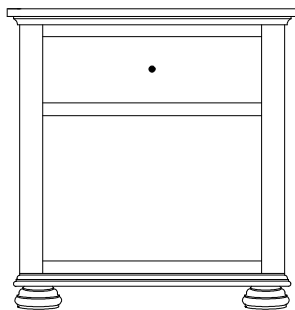

**CC-2543 Night Stand**  
28 $\frac{1}{2}$ "w 29 $\frac{1}{2}$ "h 17 $\frac{3}{4}$ "d  
w/1 drawer

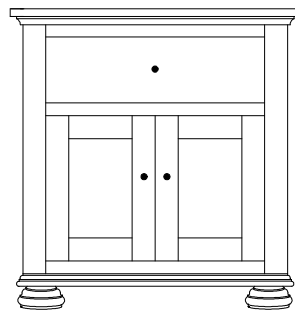

**CC-2544 Night Stand**  
28 $\frac{1}{2}$ "w 29 $\frac{1}{2}$ "h 17 $\frac{3}{4}$ "d  
w/1 drawer, 2 doors

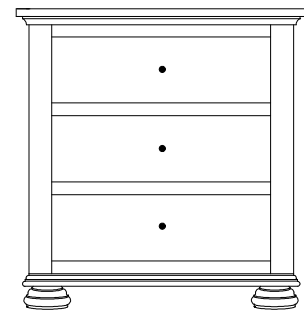

**CC-2545 Night Stand**  
28 $\frac{1}{2}$ "w 29 $\frac{1}{2}$ "h 17 $\frac{3}{4}$ "d  
w/3 drawers

# Canyon Creek Lingeries & Chests



**CC-2550**  
Chest shown

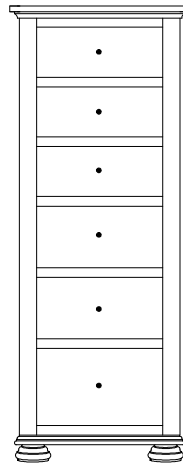

**CC-2546 Lingerie**  
23 $\frac{3}{8}$ "w 59 $\frac{1}{4}$ "h 21 $\frac{3}{4}$ "d  
w/7 drawers

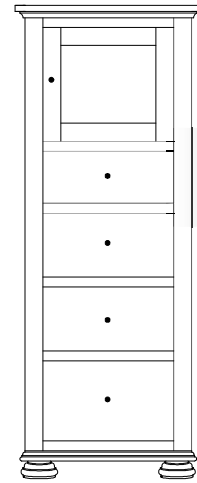

Available with  
mirror in  
door panel

**CC-2547 Lingerie**  
23 $\frac{3}{8}$ "w 59 $\frac{1}{4}$ "h 21 $\frac{3}{4}$ "d  
w/4 drawers, 1 wood door,  
1 adjustable shelf



**CC-2549 4-Drawer Chest**  
37 $\frac{3}{4}$ "w 36 $\frac{1}{2}$ "h 21 $\frac{3}{4}$ "d  
w/4 drawers

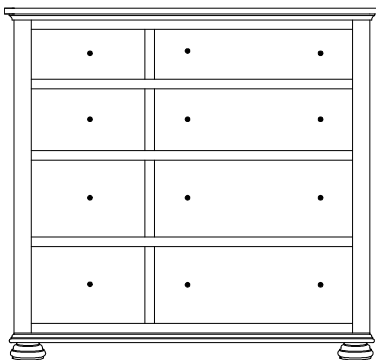

**CC-2548 8-Drawer Chest**  
48 $\frac{3}{4}$ "w 45 $\frac{3}{4}$ "h 21 $\frac{3}{4}$ "d  
w/8 drawers

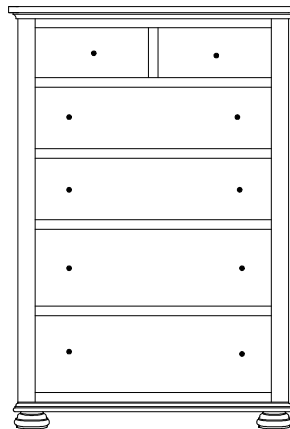

**CC-2550 Chest**  
37 $\frac{3}{4}$ "w 55" h 21 $\frac{3}{4}$ "d  
w/6 drawers

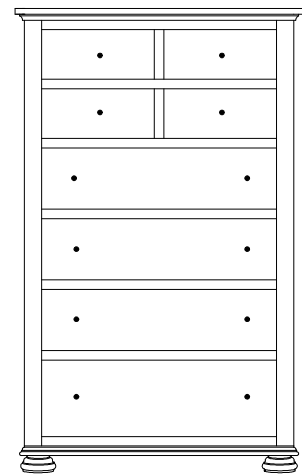

**CC-2551 Hi-Boy**  
37 $\frac{3}{4}$ "w 60 $\frac{3}{4}$ "h 21 $\frac{3}{4}$ "d  
w/8 drawers

# Canyon Creek Miscellaneous

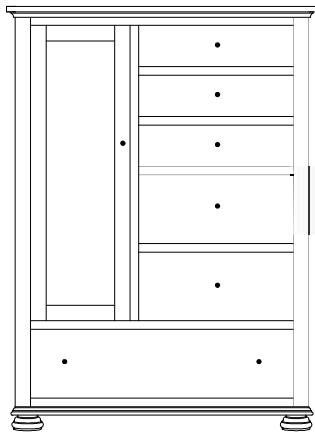

Option:  
Mirror on  
back of door

**CC-2552 Chifferobe**  
45¼"w 61¾"h 21¾"d  
w/6 drawers, 1 door, 2 adj. shelves

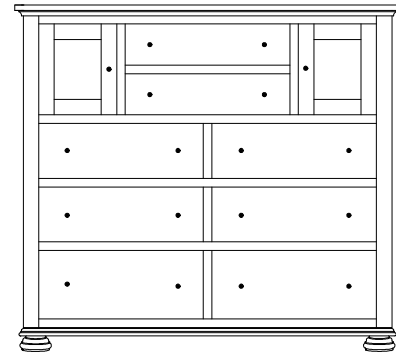

**CC-2553 His & Hers Chest**  
56¼"w 50½"h 21¾"d  
w/8 drawers, 2 doors

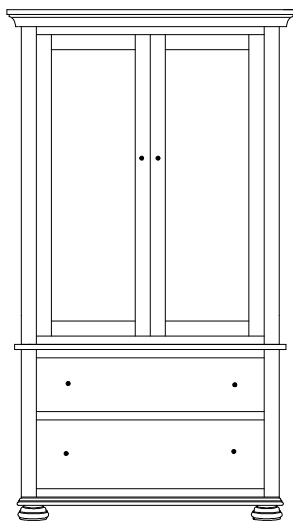

**CC-2562 Armoire**  
42"w 76¼"h 22¼"d  
w/2 drawers, w/2 doors,  
2 adj. shelves & closet rod

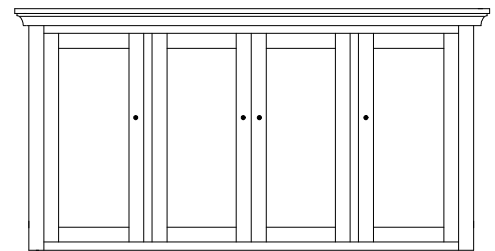

**CC-2559 Mule Chest Top**  
70¾"w 36½"h 21¾"d  
w/4 doors & 6 adjustable shelves

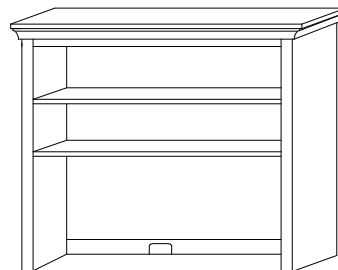

**CC-2597 Study Carrel**  
49½"w 42"h 13¾"d  
w/2 adjustable shelves

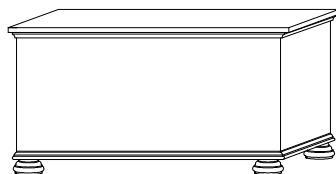

**CC-2535 Blanket Chest**  
42"w 22"h 21½"d

- Available  
with aromatic  
cedar bottom  
- Fabric or  
Leather Seat

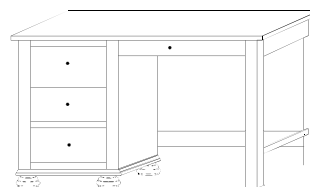

**CC-2599 Student Desk**  
48"w 28¾"h 23"d  
w/3 drawers  
w/1 pencil drawer

Upgrades available on student desk:

Keyboard slideout instead of pencil drawer  
File drawer instead of bottom 2 drawers

# Canyon Creek Dressers



CC-2558 Dresser shown with MI-2532 Mirror

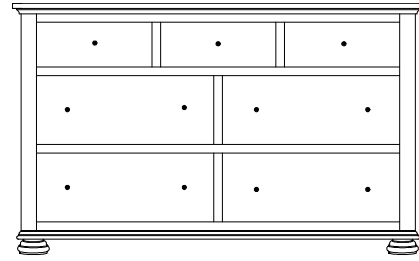

**CC-2554 Dresser**  
59¾"w 36½"h 21¾"d  
w/7 drawers

Suggested Mirrors:

**MI-2530 Mirror**  
45"h 36"w

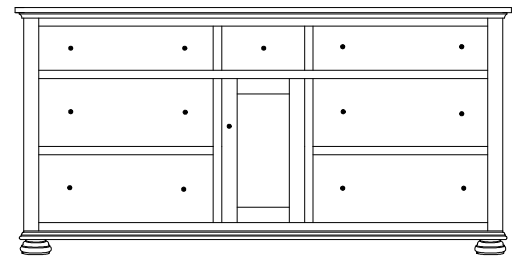

**CC-2556 Dresser**  
73¼"w 36½"h 21¾"d  
w/7 drawers, 1 door  
w/1 adjustable shelf

Suggested Mirrors:

**MI-2531 Mirror**  
45"h 46"w

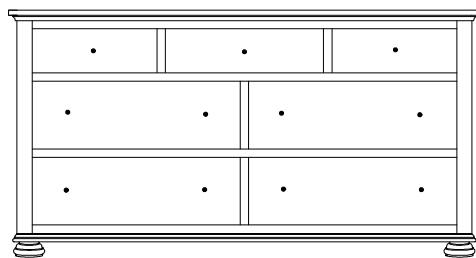

**CC-2555 Dresser**  
69¾"w 36½"h 21¾"d  
w/7 drawers

Suggested Mirrors:

**MI-2531 Mirror**  
45"h 46"w

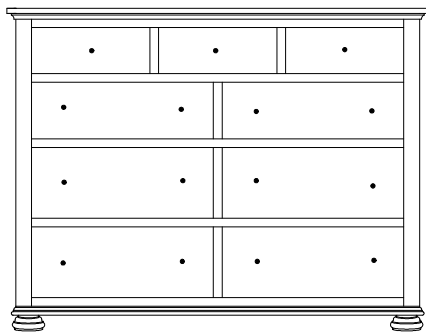

**CC-2557 Dresser**  
59¾"w 45¾"h 21¾"d  
w/9 drawers

Suggested Mirrors:

**MI-2532 Mirror**  
37"h 42"w

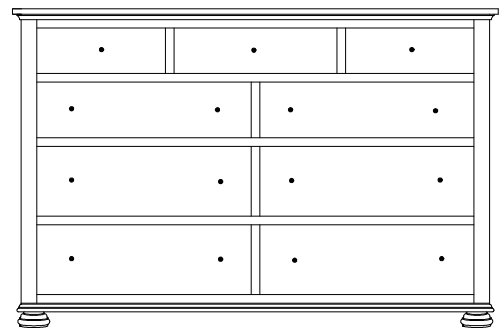

**CC-2558 Dresser**  
69¾"w 45¾"h 21¾"d  
w/9 drawers

Suggested Mirrors:

**MI-2533 Mirror**  
37"h 52"w

# Canyon Creek Mirrors

---



**MI-2530 Mirror**  
45"h 36"w

**MI-2531 Mirror**  
45"h 46"w

**MI-2532 Mirror**  
37"h 42"w

**MI-2533 Mirror**  
37"h 52"w

Beveled Mirror

# Canyon Creek Bed Frames



Bed shown with **Regular Footboard** and **Optional Leather Panels**

## Canyon Creek Bed

### Regular Footboard

Available with underbed storage options.

**CC-2565-K** (King)  
82 $\frac{5}{8}$ "w 88"l  
HB 58"h ■ FB 27"h

**CC-2565-Q** (Queen)  
67"w 88"l  
HB 58"h ■ FB 27"h

**CC-2565-F** (Full)  
59 $\frac{7}{8}$ "w 83"l  
HB 58"h ■ FB 27"h

**CC-2565-T** (Twin)  
45"w 83"l  
HB 58"h ■ FB 27"h

### Low Footboard

**CC-2566-K** (King)  
82 $\frac{5}{8}$ "w 86 $\frac{1}{4}$ "l  
HB 458"h ■ FB 14 $\frac{3}{4}$ "h

**CC-2566-Q** (Queen)  
67"w 86 $\frac{1}{4}$ "l  
HB 58"h ■ FB 14 $\frac{3}{4}$ "h

**CC-2566-F** (Full)  
59 $\frac{7}{8}$ "w 81 $\frac{1}{4}$ "l  
HB 58"h ■ FB 14 $\frac{3}{4}$ "h

**CC-2566-T** (Twin)  
45"w 81 $\frac{1}{4}$ "l  
HB 58"h ■ FB 14 $\frac{3}{4}$ "h

### Headboard Only

**CC-2567K-HB** (King)  
58" high

**CC-2567Q-HB** (Queen)  
58" high

**CC-2567F-HB** (Full)  
58" high

**CC-2567T-HB** (Twin)  
58" high

# Canyon Creek Storage Rail Upgrades

## 12<sup>3</sup>/<sub>4</sub>" From Floor to Box Spring

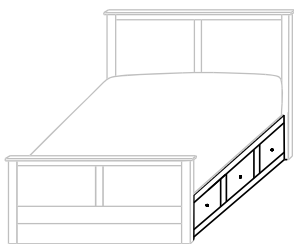

- With 3 drawers on each side
- 12<sup>3</sup>/<sub>4</sub>" from floor to Box Spring
- Inside drawer dimensions on all sizes  
9<sup>1</sup>/<sub>4</sub>"h 18<sup>7</sup>/<sub>8</sub>"w 22<sup>1</sup>/<sub>2</sub>"d

**532-SR-K** King – 6 drawers  
**532-SR-Q** Queen – 6 drawers  
**532-SR-F** Full – 6 drawers  
**532-SR-T** Twin – 3 drawers

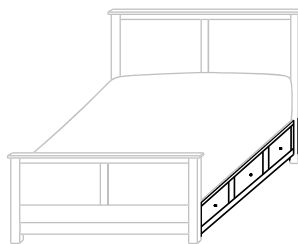

- With 3" Toe Kick
- With 3 drawers on each side
- 12<sup>3</sup>/<sub>4</sub>" from floor to Box Spring
- Inside drawer dimensions on all sizes  
6<sup>1</sup>/<sub>4</sub>"h 18<sup>7</sup>/<sub>8</sub>"w 22<sup>1</sup>/<sub>2</sub>"d

**234-SR-K** King – 6 drawers  
**234-SR-Q** Queen – 6 drawers  
**234-SR-F** Full – 6 drawers  
**234-SR-T** Twin – 3 drawers

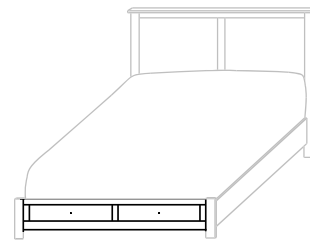

- 12<sup>3</sup>/<sub>4</sub>" from floor to Box Spring
- Inside drawer dimensions  
6<sup>1</sup>/<sub>4</sub>"h 22<sup>1</sup>/<sub>2</sub>"d  
 (King) 31"w      (Queen) 23<sup>1</sup>/<sub>4</sub>"w  
 (Full) 19<sup>5</sup>/<sub>8</sub>"w      (Twin) 29<sup>1</sup>/<sub>4</sub>"w

**685-FDS-K** King – 2 drawers  
**685-FDS-Q** Queen – 2 drawers  
**685-FDS-F** Full – 2 drawers  
**685-FDS-T** Twin – 1 drawer

## 19<sup>3</sup>/<sub>4</sub>" From Floor to Box Spring

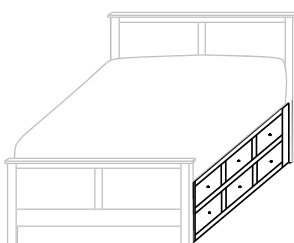

- With 6 drawers on each side
- Twin has 6 drawers on 1 side only
- 19<sup>3</sup>/<sub>4</sub>" from floor to Box Spring
- Inside drawer dimensions on all sizes  
6<sup>1</sup>/<sub>4</sub>"h 18<sup>7</sup>/<sub>8</sub>"w 22<sup>1</sup>/<sub>2</sub>"d

**654-SR-K** King – 12 drawers  
**654-SR-Q** Queen – 12 drawers  
**654-SR-F** Full – 12 drawers  
**654-SR-T** Twin – 6 drawers

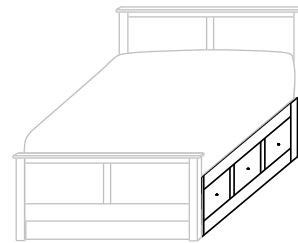

- With 3 drawers on each side
- 19<sup>3</sup>/<sub>4</sub>" from floor to Box Spring
- Inside drawer dimensions on all sizes  
10<sup>1</sup>/<sub>4</sub>"h 18<sup>7</sup>/<sub>8</sub>"w 22<sup>1</sup>/<sub>2</sub>"d

**325-SR-K** King – 6 drawers  
**325-SR-Q** Queen – 6 drawers  
**325-SR-F** Full – 6 drawers  
**325-SR-T** Twin – 3 drawers

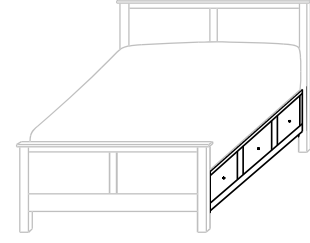

- With 7" Toe Kick
- With 3 drawers on each side
- 19<sup>3</sup>/<sub>4</sub>" from floor to Box Spring
- Inside drawer dimensions on all sizes  
9<sup>1</sup>/<sub>4</sub>"h 18<sup>7</sup>/<sub>8</sub>"w 22<sup>1</sup>/<sub>2</sub>"d

**236-SR-K** King – 6 drawers  
**236-SR-Q** Queen – 6 drawers  
**236-SR-F** Full – 6 drawers  
**236-SR-T** Twin – 3 drawers

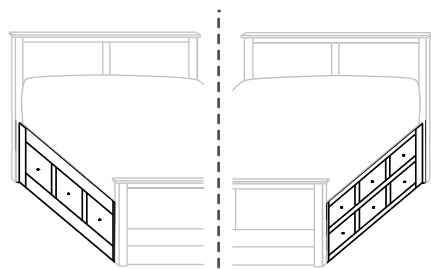

- With 3 drawers on one side and 6 drawers on other side
- 19<sup>3</sup>/<sub>4</sub>" from floor to Box Spring

**420-SR-K** King – 9 drawers  
**420-SR-Q** Queen – 9 drawers  
**420-SR-F** Full – 9 drawers  
 (Twin Not Available)

### Additional Upgrades

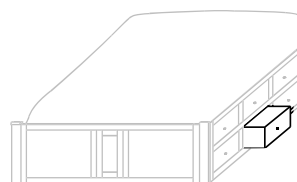

- With Step Stool Pullout in place of drawer

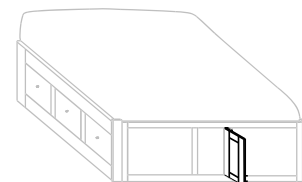

- With Door in Footboard to access area between rails





*Chelsea*

Bedroom Collection

# Chelsea



## Chelsea Bedroom Collection w/Rainbow Panel Bed

- CA-443Q Queen Bed
- CS-1639 Night Stand
- CS-1650 Chest
- CS-1654 Dresser
- MI-1730 Mirror

Shown above in **Brown Maple** with **OCS-111 Boston** and **53005-ORB Hardware**

### Standard Features:



53005-ORB Knobs



Standard with side-mount drawer slides



Stained poplar drawer boxes



Dovetailed bed slats



- RW-1910Q Rosewood Poster Bed
- CS-1645 Night Stand
- CS-1651 Hi-Boy
- CS-1657 Dresser
- MI-1632 Mirror
- CS-1635 Blanket Chest

Shown in *Rustic Cherry* with **OCS-104 Seely** and **53005-ORB Hardware**

### Available Upgrades:

- Any hardware on our Hardware Options Sheet
- Undermount soft close slides [See Price List]

# Chelsea Night Stands



**CS-1645**  
Night Stand shown



Sliding top option available on all night stands  
(Hidden compartment w/Lock)

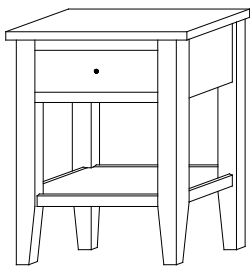

**CS-1639 Night Stand**  
21¼" w 28" h 18½" d  
w/1 drawer

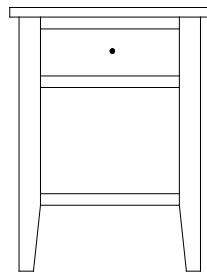

**CS-1640 Night Stand**  
21¼" w 28" h 17½" d  
w/1 drawer

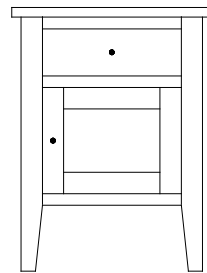

**CS-1641 Night Stand**  
21¼" w 28" h 17½" d  
w/1 drawer, 1 door

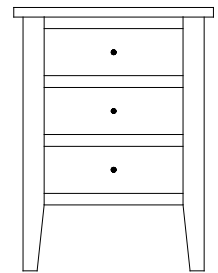

**CS-1642 Night Stand**  
21¼" w 28" h 17½" d  
w/3 drawers

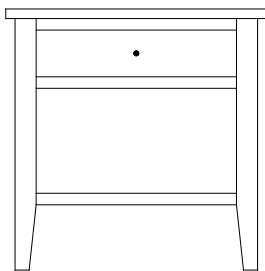

**CS-1643 Night Stand**  
28" w 28" h 17½" d  
w/1 drawer

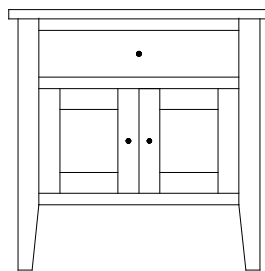

**CS-1644 Night Stand**  
28" w 28" h 17½" d  
w/1 drawer, 2 doors

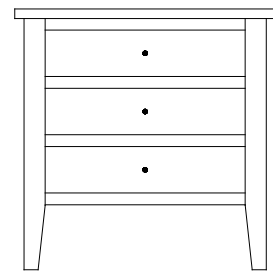

**CS-1645 Night Stand**  
28" w 28" h 17½" d  
w/3 drawers

# Chelsea Lingeries & Chests



**CS-1651**  
Hi-Boy shown

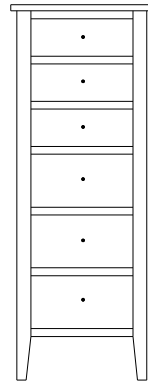

**CS-1646 Lingerie**  
23"w 60¼"h 21½"d  
w/6 drawers

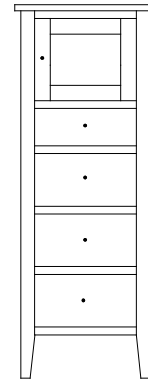

Available with  
mirror panel  
in door

**CS-1647 Lingerie**  
23"w 60¼"h 21½"d  
w/4 drawers, 1 wood door,  
1 adjustable shelf



**CS-1649 Chest**  
37¼"w 36"h 21½"d  
w/4 drawers

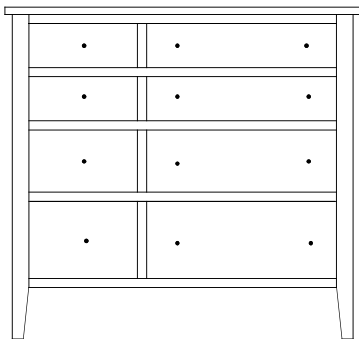

**CS-1648 Chest**  
48¼"w 45¼"h 21½"d  
w/8 drawers

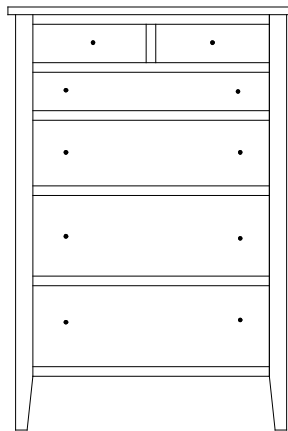

**CS-1650 Chest**  
37¼"w 54"h 21½"d  
w/6 drawers

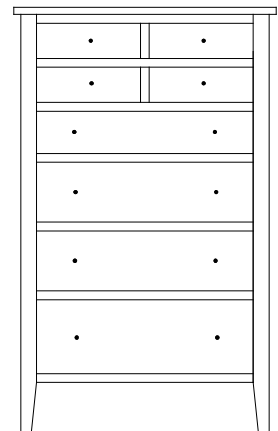

**CS-1651 Hi-Boy**  
37¼"w 60¼"h 21½"d  
w/8 drawers

# Chelsea Miscellaneous

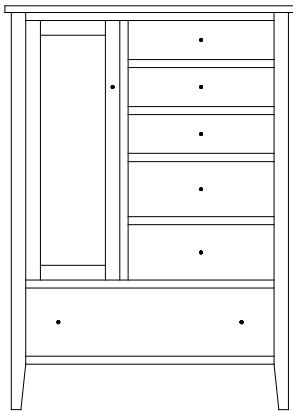

Option:  
Mirror on  
back of door

**CS-1652 Chifferobe**  
44<sup>3</sup>/<sub>4</sub>"w 62<sup>1</sup>/<sub>4</sub>"h 21<sup>1</sup>/<sub>2</sub>"d  
w/6 drawers, 1 door, 2 adj. shelves

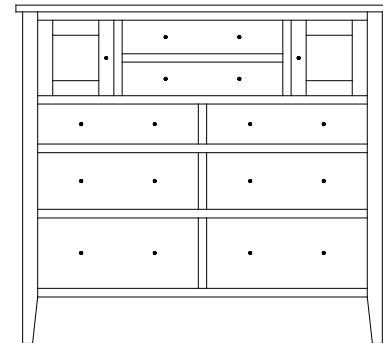

**CS-1653 His & Hers**  
55<sup>3</sup>/<sub>4</sub>"w 50<sup>1</sup>/<sub>2</sub>"h 21<sup>1</sup>/<sub>2</sub>"d  
w/8 drawers, 2 doors

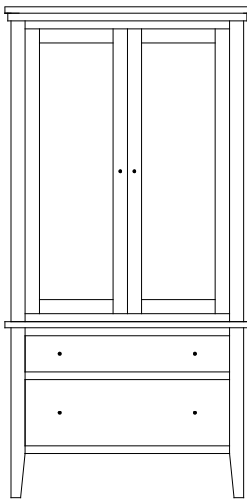

**CS-1662 Armoire**  
40<sup>1</sup>/<sub>2</sub>"w 78"h 21<sup>1</sup>/<sub>2</sub>"d  
w/2 drawers, (top drawer w/divider)  
w/2 doors, 2 adj. shelves & closet rod

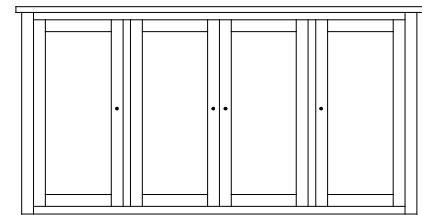

**CS-1659 Mule Chest Top**  
69<sup>1</sup>/<sub>4</sub>"w 35"h 21<sup>1</sup>/<sub>2</sub>"d  
w/4 doors & 6 adjustable shelves

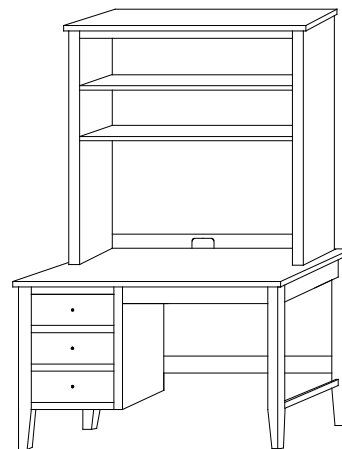

**CS-1697 Study Carrel**  
48"w 42"h 13"d  
w/2 adjustable shelves

**CS-1699 Student Desk**  
48"w 29<sup>1</sup>/<sub>2</sub>"h 22<sup>1</sup>/<sub>2</sub>"d  
w/3 drawers  
w/1 pencil drawer

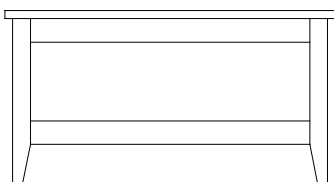

**CS-1635 Blanket Chest**  
42"w 22"h 21<sup>1</sup>/<sub>2</sub>"d

Available  
with aromatic  
cedar bottom

Upgrades available on student desk:

Keyboard slideout instead of pencil drawer  
File drawer instead of bottom 2 drawers

# Chelsea Dressers



CS-1657 Dresser shown with MI-1632 Mirror

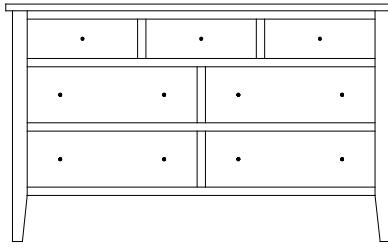

**CS-1654 Dresser**  
59¼" w 36" h 21½" d  
w/7 drawers

Suggested Mirrors:

**MI-1630 Mirror**  
40" h 36" w

**MI-1730 Mirror**  
40" h 36" w

**MI-1830 Mirror**  
40" h 36" w

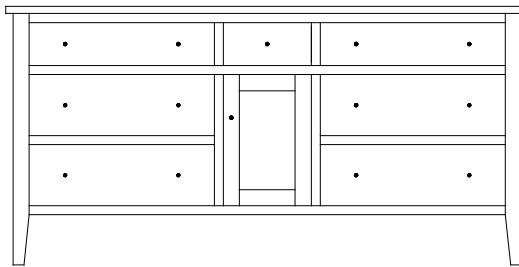

**CS-1656 Dresser**  
72¾" w 36" h 21½" d  
w/7 drawers, 1 door  
w/1 adjustable shelf

Suggested Mirrors:

**MI-1631 Mirror**  
40" h 46" w

**MI-1731 Mirror**  
40" h 46" w

**MI-1831 Mirror**  
40" h 46" w

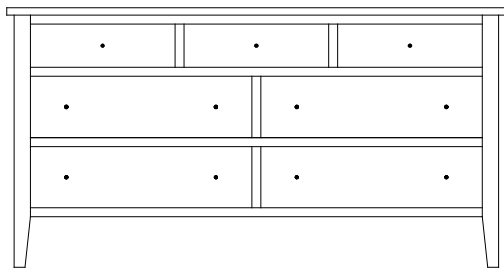

**CS-1655 Dresser**  
69¼" w 36" h 21½" d  
w/7 drawers

Suggested Mirrors:

**MI-1631 Mirror**  
40" h 46" w

**MI-1731 Mirror**  
40" h 46" w

**MI-1831 Mirror**  
40" h 46" w

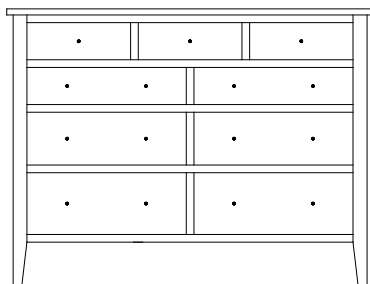

**CS-1657 Tall Dresser**  
59¼" w 45¼" h 21½" d  
w/9 drawers

Suggested Mirrors:

**MI-1632 Mirror**  
32" h 42" w

**MI-1732 Mirror**  
32" h 42" w

**MI-1832 Mirror**  
32" h 42" w

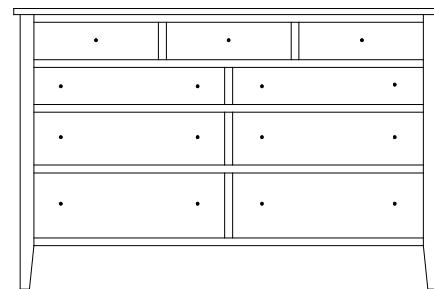

**CS-1658 Dresser**  
69¼" w 45¼" h 21½" d  
w/9 drawers

Suggested Mirrors:

**MI-1633 Mirror**  
32" h 52" w

**MI-1733 Mirror**  
32" h 52" w

**MI-1833 Mirror**  
32" h 52" w

# Chelsea Mirrors



Beveled Mirror

**MI-1630 Mirror**  
40"high 36"wide

**MI-1631 Mirror**  
40"high 46"wide

**MI-1632 Mirror**  
32"high 42"wide

**MI-1633 Mirror**  
32"high 52"wide



Beveled Mirror

**MI-1730 Mirror**  
40"high 36"wide

**MI-1731 Mirror**  
40"high 46"wide

**MI-1732 Mirror**  
32"high 42"wide

**MI-1733 Mirror**  
32"high 52"wide



Beveled Mirror

**MI-1830 Mirror**  
40"high 36"wide

**MI-1831 Mirror**  
40"high 46"wide

**MI-1832 Mirror**  
32"high 42"wide

**MI-1833 Mirror**  
32"high 52"wide

# Chelsea Bed Frames



Post Height 80"  
Posts are removable

shown with Regular Footboard



shown with Regular Footboard

## Rosewood Poster Beds

Available  
with underbed  
storage options.

### Regular Footboard

**RW-1910-K** (King)  
80 1/8"w 87 1/2"l  
HB 52"h ■ FB 23"h

**RW-1910-Q** (Queen)  
64 3/8"w 87 1/2"l  
HB 52"h ■ FB 23"h

**RW-1910-F** (Full)  
57 3/8"w 82 1/2"l  
HB 52"h ■ FB 23"h

**RW-1910-T** (Twin)  
42 1/2"w 82 1/2"l  
HB 52"h ■ FB 23"h

### Headboard Only

**RW-1920K-HB** (King)  
52" high

**RW-1920Q-HB** (Queen)  
52" high

**RW-1920F-HB** (Full)  
52" high

**RW-1920T-HB** (Twin)  
52" high

## Rainbow Panel Beds

Available  
with underbed  
storage options.

### Regular Footboard

**CA-441-K** (King)  
85 3/4"w 87"l  
HB 59 1/4"h ■ FB 30 1/4"h

**CA-441-Q** (Queen)  
70 1/4"w 87"l  
HB 57 1/4"h ■ FB 30 1/4"h

**CA-441-F** (Full)  
63"w 82"l  
HB 55 3/4"h ■ FB 30 1/4"h

**CA-441-T** (Twin)  
48 1/8"w 82"l  
HB 53 3/4"h ■ FB 30 1/4"h

### Low Footboard

**CA-443-K** (King)  
85 3/4"w 85 3/4"l  
HB 59 1/4"h ■ FB 14 3/4"h

**CA-443-Q** (Queen)  
70 1/4"w 85 3/4"l  
HB 57 1/4"h ■ FB 14 3/4"h

**CA-443-F** (Full)  
63"w 80 3/4"l  
HB 55 3/4"h ■ FB 14 3/4"h

**CA-443-T** (Twin)  
48 1/8"w 80 3/4"l  
HB 53 3/4"h ■ FB 14 3/4"h

### Headboard Only

**CA-446K-HB** (King)  
59 1/4" high

**CA-446Q-HB** (Queen)  
57 1/4" high

**CA-446F-HB** (Full)  
55 3/4" high

**CA-446T-HB** (Twin)  
53 3/4" high

# Chelsea Storage Rail Upgrades

## 12<sup>3</sup>/<sub>4</sub>" From Floor to Box Spring

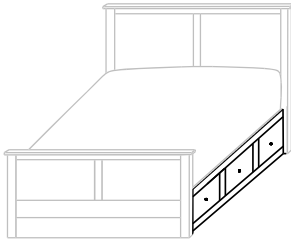

- With 3 drawers on each side
- 12<sup>3</sup>/<sub>4</sub>" from floor to Box Spring
- Inside drawer dimensions on all sizes  
9<sup>1</sup>/<sub>4</sub>"h 18<sup>7</sup>/<sub>8</sub>"w 22<sup>1</sup>/<sub>2</sub>"d

**532-SR-K** King – 6 drawers  
**532-SR-Q** Queen – 6 drawers  
**532-SR-F** Full – 6 drawers  
**532-SR-T** Twin – 3 drawers

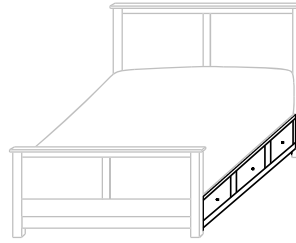

- With 3" Toe Kick
- With 3 drawers on each side
- 12<sup>3</sup>/<sub>4</sub>" from floor to Box Spring
- Inside drawer dimensions on all sizes  
6<sup>1</sup>/<sub>4</sub>"h 18<sup>7</sup>/<sub>8</sub>"w 22<sup>1</sup>/<sub>2</sub>"d

**234-SR-K** King – 6 drawers  
**234-SR-Q** Queen – 6 drawers  
**234-SR-F** Full – 6 drawers  
**234-SR-T** Twin – 3 drawers

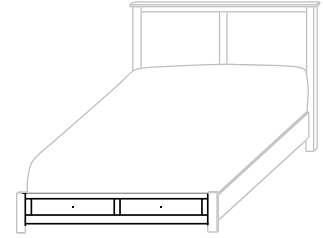

- 12<sup>3</sup>/<sub>4</sub>" from floor to Box Spring
- Inside drawer dimensions  
6<sup>1</sup>/<sub>4</sub>"h 22<sup>1</sup>/<sub>2</sub>"d  
 (King) 31"w      (Queen) 23<sup>1</sup>/<sub>4</sub>"w  
 (Full) 19<sup>5</sup>/<sub>8</sub>"w      (Twin) 29<sup>1</sup>/<sub>4</sub>"w

**685-FDS-K** King – 2 drawers  
**685-FDS-Q** Queen – 2 drawers  
**685-FDS-F** Full – 2 drawers  
**685-FDS-T** Twin – 1 drawer

## 19<sup>3</sup>/<sub>4</sub>" From Floor to Box Spring

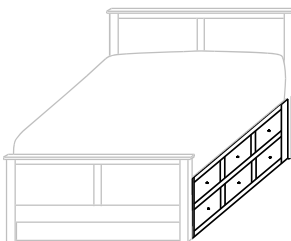

- With 6 drawers on each side
- Twin has 6 drawers on 1 side only
- 19<sup>3</sup>/<sub>4</sub>" from floor to Box Spring
- Inside drawer dimensions on all sizes  
6<sup>1</sup>/<sub>4</sub>"h 18<sup>7</sup>/<sub>8</sub>"w 22<sup>1</sup>/<sub>2</sub>"d

**654-SR-K** King – 12 drawers  
**654-SR-Q** Queen – 12 drawers  
**654-SR-F** Full – 12 drawers  
**654-SR-T** Twin – 6 drawers

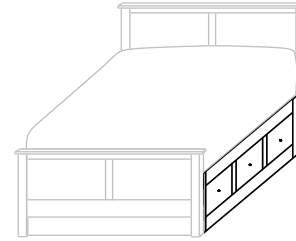

- With 3 drawers on each side
- 19<sup>3</sup>/<sub>4</sub>" from floor to Box Spring
- Inside drawer dimensions on all sizes  
10<sup>1</sup>/<sub>4</sub>"h 18<sup>7</sup>/<sub>8</sub>"w 22<sup>1</sup>/<sub>2</sub>"d

**325-SR-K** King – 6 drawers  
**325-SR-Q** Queen – 6 drawers  
**325-SR-F** Full – 6 drawers  
**325-SR-T** Twin – 3 drawers

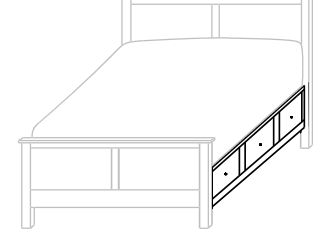

- With 7" Toe Kick
- With 3 drawers on each side
- 19<sup>3</sup>/<sub>4</sub>" from floor to Box Spring
- Inside drawer dimensions on all sizes  
9<sup>1</sup>/<sub>4</sub>"h 18<sup>7</sup>/<sub>8</sub>"w 22<sup>1</sup>/<sub>2</sub>"d

**236-SR-K** King – 6 drawers  
**236-SR-Q** Queen – 6 drawers  
**236-SR-F** Full – 6 drawers  
**236-SR-T** Twin – 3 drawers

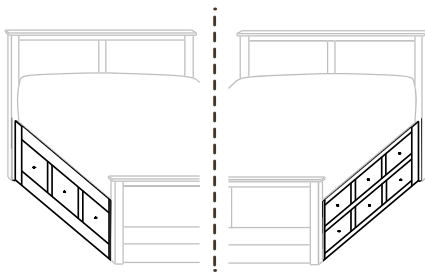

- With 3 drawers on one side and 6 drawers on other side
- 19<sup>3</sup>/<sub>4</sub>" from floor to Box Spring

**420-SR-K** King – 9 drawers  
**420-SR-Q** Queen – 9 drawers  
**420-SR-F** Full – 9 drawers  
 (Twin Not Available)

### Additional Upgrades

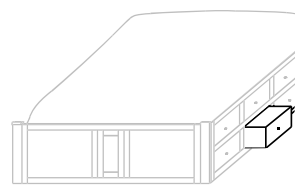

- With Step Stool Pullout in place of drawer

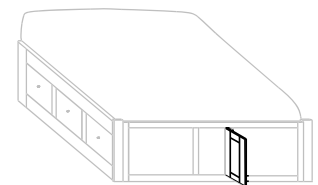

- With Door in Footboard to access area between rails





*Claremont Mission*  
Bedroom Collection

# Claremont Mission



## Claremont Mission Bedroom Collection w/Claremont Panel Bed

- CM-2003Q Queen Bed
- CM-1540 Night Stand
- CM-1550 Chest
- CM-1554 Dresser
- MI-1965 Mirror

Shown above in **Brown Maple** with **OCS-122 Cocoa** and **4424-G10 Hardware**

### Standard Features:

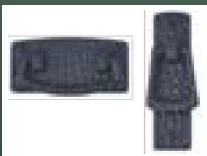

D925-BL & D924-BL



Standard with side-mount drawer slides



Stained poplar drawer boxes



Dovetailed bed slats

### Available Upgrades:

- Any hardware on our Hardware Options Sheet
- Undermount soft close slides [See Price List]



- CM-1983Q Claremont Slat Bed w/234-SR Storage Upgrade
- CM-1545 Night Stand
- CM-1551 Hi-Boy
- CM-1558 Dresser
- MI-1568 Mirror

Shown in **QWO** with **OCS-113 Michaels** and **D925-BL Hardware**

# Claremont Mission Night Stands



**CM-1545**  
Night Stand shown



Sliding top option available on all night stands  
(Hidden compartment w/Lock)

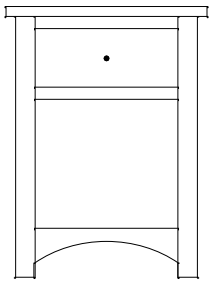

**CM-1540 Night Stand**  
20<sup>3</sup>/<sub>4</sub>"w 27<sup>3</sup>/<sub>4</sub>"h 17<sup>1</sup>/<sub>2</sub>"d  
w/1 drawer

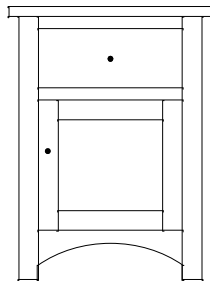

**CM-1541 Night Stand**  
20<sup>3</sup>/<sub>4</sub>"w 27<sup>3</sup>/<sub>4</sub>"h 17<sup>1</sup>/<sub>2</sub>"d  
w/1 drawer, 1 door

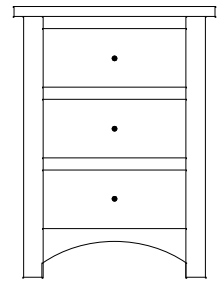

**CM-1542 Night Stand**  
20<sup>3</sup>/<sub>4</sub>"w 27<sup>3</sup>/<sub>4</sub>"h 17<sup>1</sup>/<sub>2</sub>"d  
w/3 drawers

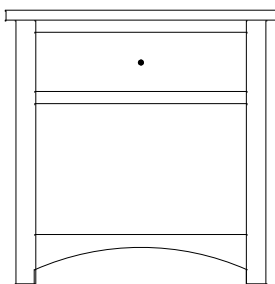

**CM-1543 Night Stand**  
27<sup>1</sup>/<sub>2</sub>"w 27<sup>3</sup>/<sub>4</sub>"h 17<sup>1</sup>/<sub>2</sub>"d  
w/1 drawer

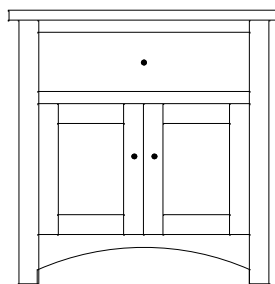

**CM-1544 Night Stand**  
27<sup>1</sup>/<sub>2</sub>"w 27<sup>3</sup>/<sub>4</sub>"h 17<sup>1</sup>/<sub>2</sub>"d  
w/1 drawer, 2 doors

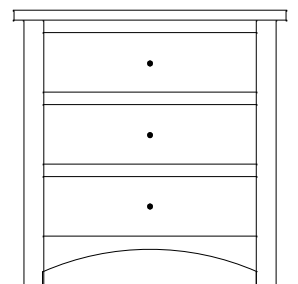

**CM-1545 Night Stand**  
27<sup>1</sup>/<sub>2</sub>"w 27<sup>3</sup>/<sub>4</sub>"h 17<sup>1</sup>/<sub>2</sub>"d  
w/3 drawers

# Claremont Mission Lingeries & Chests



**CM-1551**  
Hi-Boy shown

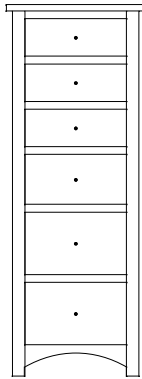

**CM-1546 Lingerie**  
22 $\frac{3}{8}$ "w 59 $\frac{1}{2}$ "h 21 $\frac{1}{2}$ "d  
w/6 drawers

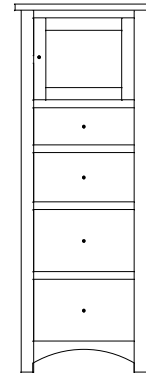

Available with  
mirror panel  
in door

**CM-1547 Lingerie**  
22 $\frac{3}{8}$ "w 59 $\frac{1}{2}$ "h 21 $\frac{1}{2}$ "d  
w/4 drawers, 1 wood door,  
1 adjustable shelf

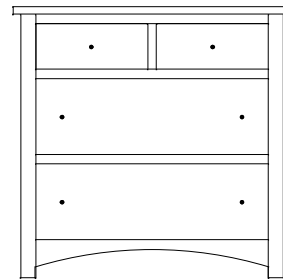

**CM-1549 Chest**  
36 $\frac{3}{4}$ "w 35 $\frac{3}{4}$ "h 21 $\frac{1}{2}$ "d  
w/4 drawers

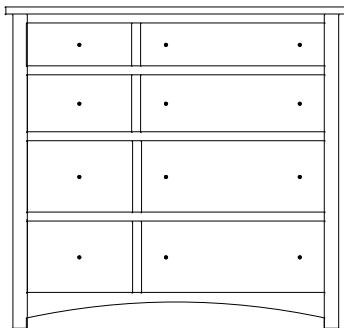

**CM-1548 Chest**  
47 $\frac{3}{4}$ "w 45"h 21 $\frac{1}{2}$ "d  
w/8 drawers

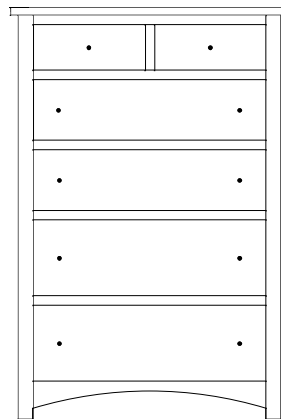

**CM-1550 Chest**  
36 $\frac{3}{4}$ "w 54 $\frac{1}{4}$ "h 21 $\frac{1}{2}$ "d  
w/6 drawers

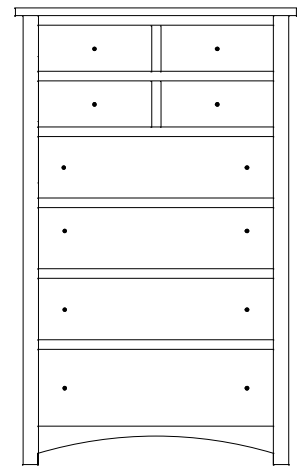

**CM-1551 Hi-Boy**  
36 $\frac{3}{4}$ "w 59 $\frac{1}{2}$ "h 21 $\frac{1}{2}$ "d  
w/8 drawers

# Claremont Mission Miscellaneous

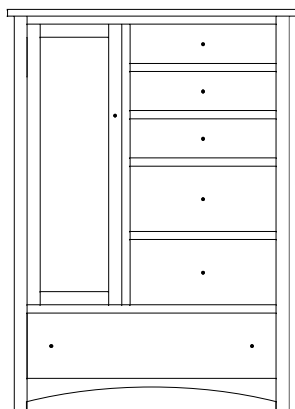

Option:  
Mirror on  
back of door

**CM-1552 Chifferobe**  
44¼"w 61½"h 21½"d  
w/6 drawers, 1 door, 2 adj. shelves

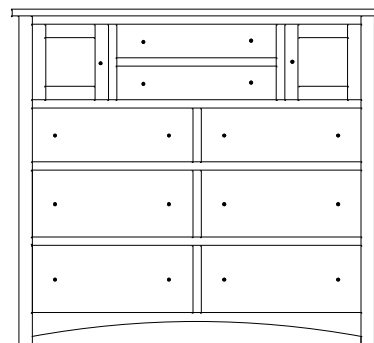

**CM-1553 His & Hers**  
55¼"w 50¼"h 21½"d  
w/8 drawers, 2 doors

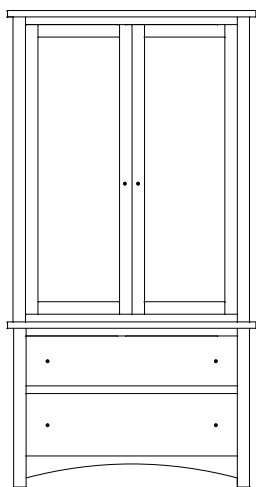

**CM-1562 Armoire**  
40"w 76¼"h 21½"d  
w/2 drawers, (top drawer w/divider)  
w/2 doors, 2 adj. shelves & closet rod

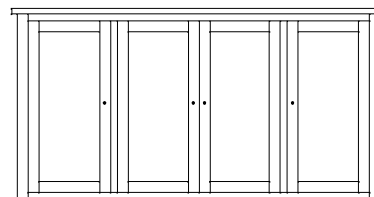

**CM-1559 Mule Chest Top**  
68¾"w 35"h 21½"d  
w/4 doors & 6 adjustable shelves

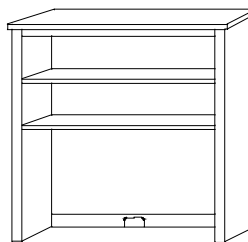

**CM-1597 Study Carrel**  
48"w 42"h 13"d  
w/2 adjustable shelves

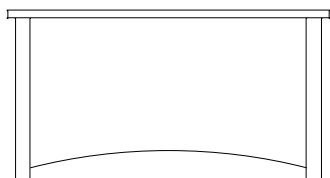

**CS-1535 Blanket Chest**  
42"w 22"h 21½"d

Available  
with aromatic  
cedar bottom

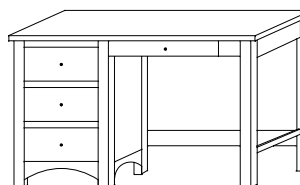

**CM-1599 Student Desk**  
48"w 29¼"h 22½"d  
w/3 drawers  
w/1 pencil drawer

Upgrades available on student desk:

Keyboard slideout instead of pencil drawer  
File drawer instead of bottom 2 drawers

# Claremont Mission Dressers



CM-1557 Dresser shown with MI-1567 Mirror

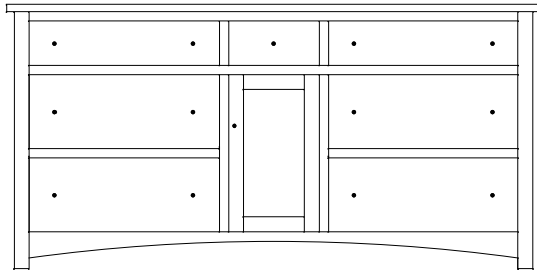

**CM-1556 Dresser**  
72¼" w 35¾" h 21½" d  
w/7 drawers, 1 door,  
1 adjustable shelf

Suggested Mirrors:

**MI-1566 Mirror**  
45" h 46" w

**MI-1731 Mirror**  
40" h 46" w

**MI-1966 Mirror**  
40" h 46" w

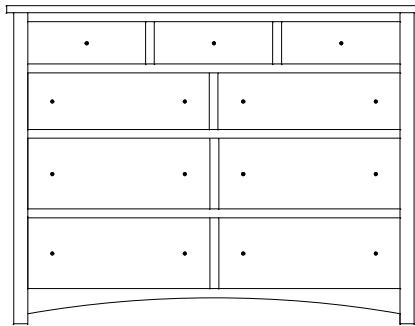

**CM-1557 Dresser**  
58¾" w 45" h 21½" d  
w/9 drawers

Suggested Mirrors:

**MI-1567 Mirror**  
37" h 42" w

**MI-1732 Mirror**  
32" h 42" w

**MI-1967 Mirror**  
32" h 42" w

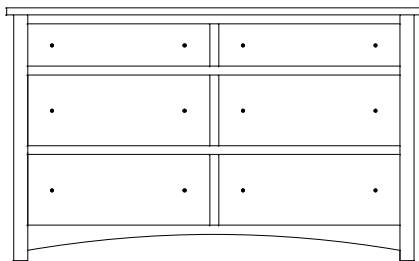

**CM-1554 Dresser**  
58¾" w 35¾" h 21½" d  
w/6 drawers

Suggested Mirrors:

**MI-1565 Mirror**  
45" h 36" w

**MI-1730 Mirror**  
40" h 36" w

**MI-1965 Mirror**  
40" h 36" w

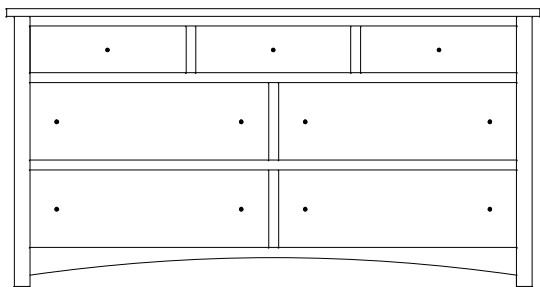

**CM-1555 Dresser**  
68¾" w 35¾" h 21½" d  
w/7 drawers

Suggested Mirrors:

**MI-1566 Mirror**  
45" h 46" w

**MI-1731 Mirror**  
40" h 46" w

**MI-1966 Mirror**  
40" h 46" w

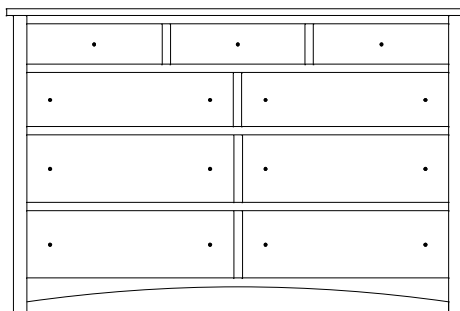

**CM-1558 Dresser**  
68¾" w 45" h 21½" d  
w/9 drawers

Suggested Mirrors:

**MI-1568 Mirror**  
37" h 52" w

**MI-1733 Mirror**  
32" h 52" w

**MI-1968 Mirror**  
32" h 52" w

# Claremont Mission Mirrors



Beveled Mirror

**MI-1565 Mirror**  
45"high 36"wide

**MI-1566 Mirror**  
45"high 46"wide

**MI-1567 Mirror**  
37"high 42"wide

**MI-1568 Mirror**  
37"high 52"wide

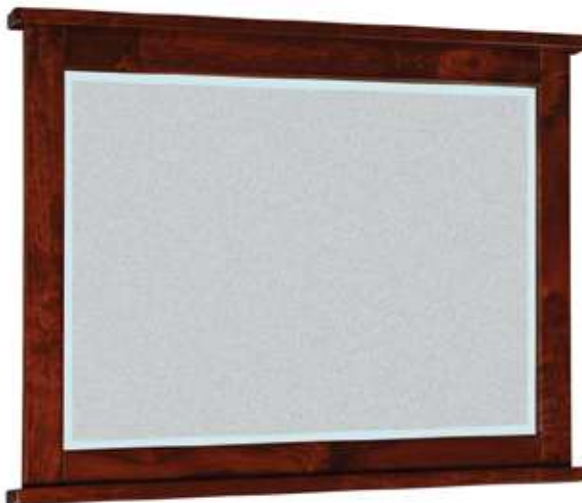

Beveled Mirror

**MI-1730 Mirror**  
40"high 36"wide

**MI-1731 Mirror**  
40"high 46"wide

**MI-1732 Mirror**  
32"high 42"wide

**MI-1733 Mirror**  
32"high 52"wide



Beveled Mirror

**MI-1965 Mirror**  
40"high 36"wide

**MI-1966 Mirror**  
40"high 46"wide

**MI-1967 Mirror**  
32"high 42"wide

**MI-1968 Mirror**  
32"high 52"wide

# Claremont Mission Bed Frames



shown with Regular Footboard



shown with Regular Footboard

## Claremont Slat Beds

Available with underbed storage options.

### Regular Footboard

**CM-1983-K (King)**  
81½" w 85¾" l  
HB 54" h ■ FB 30" h

**CM-1983-Q (Queen)**  
66½" w 85¾" l  
HB 54" h ■ FB 30" h

**CM-1983-F (Full)**  
58⅞" w 80¾" l  
HB 54" h ■ FB 30" h

**CM-1983-T (Twin)**  
44" w 80¾" l  
HB 54" h ■ FB 30" h

### Low Footboard

**CM-1990-K (King)**  
81½" w 85¾" l  
HB 54" h ■ FB 14¾" h

**CM-1990-Q (Queen)**  
66½" w 85¾" l  
HB 54" h ■ FB 14¾" h

**CM-1990-F (Full)**  
58⅞" w 80¾" l  
HB 54" h ■ FB 14¾" h

**CM-1990-T (Twin)**  
44" w 80¾" l  
HB 54" h ■ FB 14¾" h

### Headboard Only

**CM-1982K-HB (King)**  
54" high

**CM-1982Q-HB (Queen)**  
54" high

**CM-1982F-HB (Full)**  
54" high

**CM-1982T-HB (Twin)**  
54" high

## Claremont Panel Beds

Available with underbed storage options.

### Regular Footboard

**CM-2002-K (King)**  
81½" w 85¾" l  
HB 54" h ■ FB 30" h

**CM-2002-Q (Queen)**  
66½" w 85¾" l  
HB 54" h ■ FB 30" h

**CM-2002-F (Full)**  
58⅞" w 80¾" l  
HB 54" h ■ FB 30" h

**CM-2002-T (Twin)**  
44" w 80¾" l  
HB 54" h ■ FB 30" h

### Low Footboard

**CM-2003-K (King)**  
81½" w 85¾" l  
HB 54" h ■ FB 14¾" h

**CM-2003-Q (Queen)**  
66½" w 85¾" l  
HB 54" h ■ FB 14¾" h

**CM-2003-F (Full)**  
58⅞" w 80¾" l  
HB 54" h ■ FB 14¾" h

**CM-2003-T (Twin)**  
44" w 80¾" l  
HB 54" h ■ FB 14¾" h

### Headboard Only

**CM-2001K-HB (King)**  
54" high

**CM-2001Q-HB (Queen)**  
54" high

**CM-2001F-HB (Full)**  
54" high

**CM-2001T-HB (Twin)**  
54" high

# Claremont Mission Storage Rail Upgrades

## 12<sup>3</sup>/<sub>4</sub>" From Floor to Box Spring

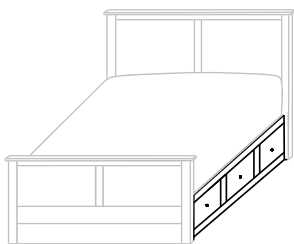

- With 3 drawers on each side
- 12<sup>3</sup>/<sub>4</sub>" from floor to Box Spring
- Inside drawer dimensions on all sizes  
9<sup>1</sup>/<sub>4</sub>"h 18<sup>7</sup>/<sub>8</sub>"w 22<sup>1</sup>/<sub>2</sub>"d

**532-SR-K** King – 6 drawers  
**532-SR-Q** Queen – 6 drawers  
**532-SR-F** Full – 6 drawers  
**532-SR-T** Twin – 3 drawers

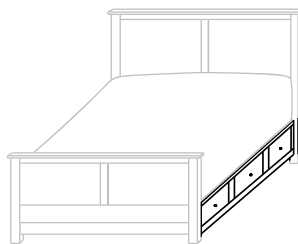

- With 3" Toe Kick
- With 3 drawers on each side
- 12<sup>3</sup>/<sub>4</sub>" from floor to Box Spring
- Inside drawer dimensions on all sizes  
6<sup>1</sup>/<sub>4</sub>"h 18<sup>7</sup>/<sub>8</sub>"w 22<sup>1</sup>/<sub>2</sub>"d

**234-SR-K** King – 6 drawers  
**234-SR-Q** Queen – 6 drawers  
**234-SR-F** Full – 6 drawers  
**234-SR-T** Twin – 3 drawers

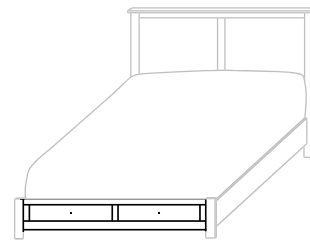

- 12<sup>3</sup>/<sub>4</sub>" from floor to Box Spring
- Inside drawer dimensions  
6<sup>1</sup>/<sub>4</sub>"h 22<sup>1</sup>/<sub>2</sub>"d  
 (King) 31" w      (Queen) 23<sup>1</sup>/<sub>4</sub>" w  
 (Full) 19<sup>5</sup>/<sub>8</sub>" w      (Twin) 29<sup>1</sup>/<sub>4</sub>" w

**685-FDS-K** King – 2 drawers  
**685-FDS-Q** Queen – 2 drawers  
**685-FDS-F** Full – 2 drawers  
**685-FDS-T** Twin – 1 drawer

## 19<sup>3</sup>/<sub>4</sub>" From Floor to Box Spring

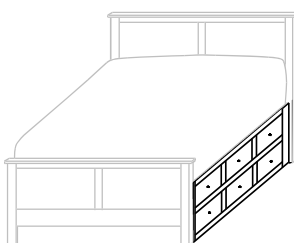

- With 6 drawers on each side
- Twin has 6 drawers on 1 side only
- 19<sup>3</sup>/<sub>4</sub>" from floor to Box Spring
- Inside drawer dimensions on all sizes  
6<sup>1</sup>/<sub>4</sub>"h 18<sup>7</sup>/<sub>8</sub>"w 22<sup>1</sup>/<sub>2</sub>"d

**654-SR-K** King – 12 drawers  
**654-SR-Q** Queen – 12 drawers  
**654-SR-F** Full – 12 drawers  
**654-SR-T** Twin – 6 drawers

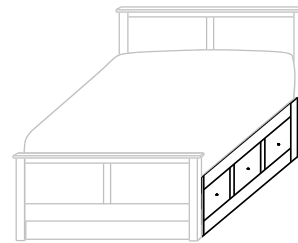

- With 3 drawers on each side
- 19<sup>3</sup>/<sub>4</sub>" from floor to Box Spring
- Inside drawer dimensions on all sizes  
10<sup>1</sup>/<sub>4</sub>"h 18<sup>7</sup>/<sub>8</sub>"w 22<sup>1</sup>/<sub>2</sub>"d

**325-SR-K** King – 6 drawers  
**325-SR-Q** Queen – 6 drawers  
**325-SR-F** Full – 6 drawers  
**325-SR-T** Twin – 3 drawers

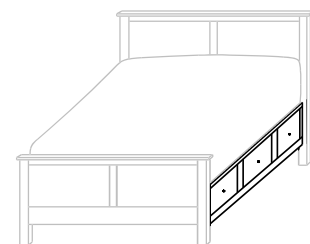

- With 7" Toe Kick
- With 3 drawers on each side
- 19<sup>3</sup>/<sub>4</sub>" from floor to Box Spring
- Inside drawer dimensions on all sizes  
9<sup>1</sup>/<sub>4</sub>"h 18<sup>7</sup>/<sub>8</sub>"w 22<sup>1</sup>/<sub>2</sub>"d

**236-SR-K** King – 6 drawers  
**236-SR-Q** Queen – 6 drawers  
**236-SR-F** Full – 6 drawers  
**236-SR-T** Twin – 3 drawers

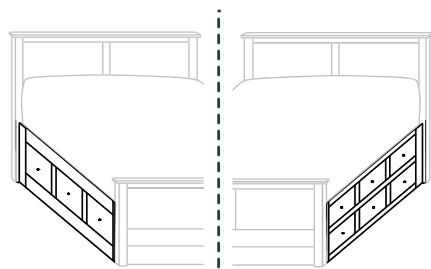

- With 3 drawers on one side and 6 drawers on other side
- 19<sup>3</sup>/<sub>4</sub>" from floor to Box Spring

**420-SR-K** King – 9 drawers  
**420-SR-Q** Queen – 9 drawers  
**420-SR-F** Full – 9 drawers  
 (Twin Not Available)

### Additional Upgrades

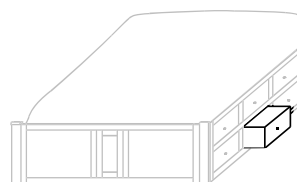

- With Step Stool Pullout in place of drawer

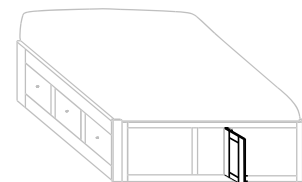

- With Door in Footboard to access area between rails





*Hamilton*  
Bedroom Collection

# Hamilton



## Hamilton Bedroom Collection w/Hamilton Bed

- HM-1882Q Queen Bed
- HM-1839 Night Stand
- HM-1850 Chest
- HM-1854 Dresser
- MI-1873 Mirror

Shown above in **Brown Maple** with **OCS-117 Asbury** and **K2017-BL Hardware**

### Standard Features:



K2017-SN Pulls



Standard with side-mount drawer slides



Stained poplar drawer boxes



Dovetailed bed slats

### Available Upgrades:

- Any hardware on our Hardware Options Sheet
- Undermount soft close slides [See Price List]



- HM-1880Q Hamilton Bed w/234-SR Storage Upgrade
- HM-1845 Night Stand
- HM-1850 Chest
- HM-1856 Dresser
- MI-1870 Mirror

Shown in **Cherry** with **FC-15743 Briar** and **K2017-SN Hardware**

# Hamilton Night Stands



**HM-1845**  
Night Stand shown



Sliding top option available on all night stands  
(Hidden compartment w/Lock)

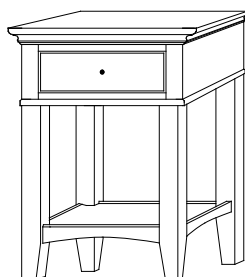

**HM-1839 Night Stand**  
22½"w 30"h 17½"d  
w/1 drawer

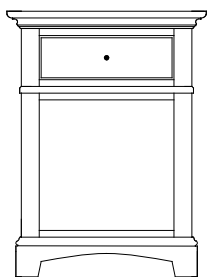

**HM-1840 Night Stand**  
22½"w 30"h 17½"d  
w/1 drawer

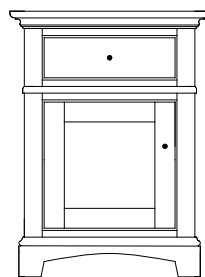

**HM-1841 Night Stand**  
22½"w 30"h 17½"d  
w/1 drawer, 1 door

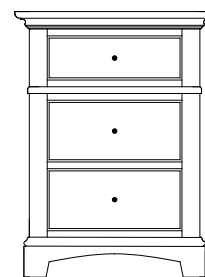

**HM-1842 Night Stand**  
22½"w 30"h 17½"d  
w/3 drawers

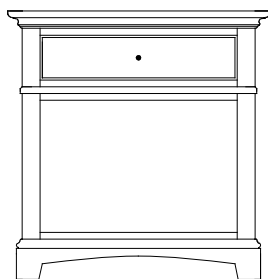

**HM-1843 Night Stand**  
29¼"w 30"h 17½"d  
w/1 drawer

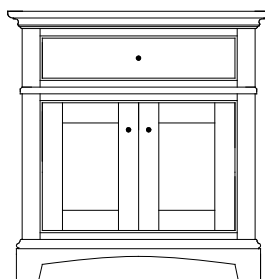

**HM-1844 Night Stand**  
29¼"w 30"h 17½"d  
w/1 drawer, 2 doors

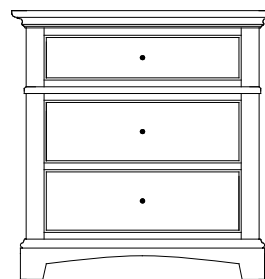

**HM-1845 Night Stand**  
29¼"w 30"h 17½"d  
w/3 drawers

# Hamilton Lingeries & Chests



**HM-1850**  
Chest shown

Available  
with aromatic  
cedar bottom

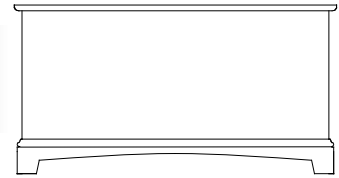

**HM-1835 Blanket Chest**  
42"w 22"h 21½"d

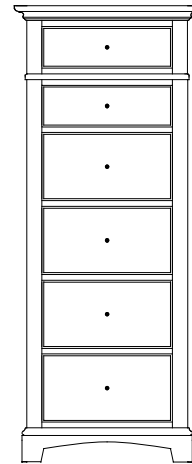

**HM-1846 Lingerie**  
24½"w 60¼"h 21½"d  
w/6 drawers



**HM-1849 Chest**  
38½"w 36½"h 21½"d  
w/4 drawers

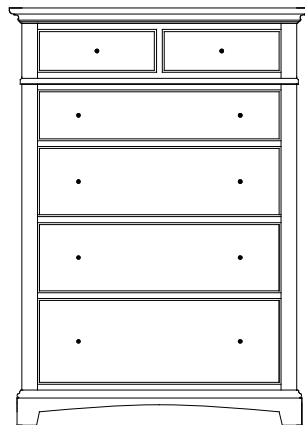

**HM-1850 Chest**  
38½"w 53½"h 21½"d  
w/6 drawers

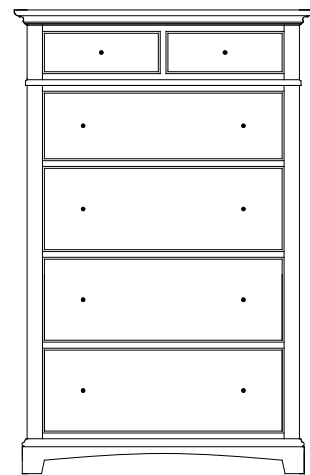

**HM-1851 Hi-Boy**  
38½"w 60h 21½"d  
w/6 drawers

# Hamilton Dressers & Mirrors



HM-1856 Dresser shown with MI-1870 Mirror

**MI-1870 Mirror**  
40"high 52"wide

**MI-1871 Mirror**  
32"high 52"wide

**MI-1872 Mirror**  
32"high 43"wide

**MI-1873 Mirror**  
40"high 43"wide

Beveled Mirror

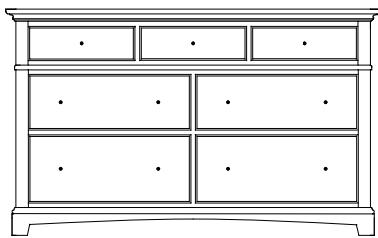

**HM-1854 Dresser**  
60½"w 36½"h 21½"d  
w/7 drawers

Suggested Mirrors:

**MI-1873 Mirror**  
40"h 43"w

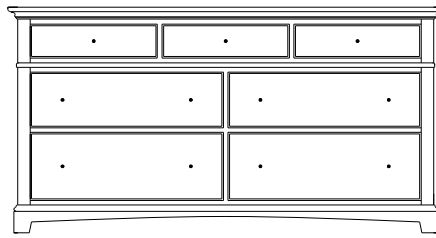

**HM-1855 Dresser**  
70½"w 36½"h 21½"d  
w/7 drawers

Suggested Mirrors:

**MI-1870 Mirror**  
40"h 52"w

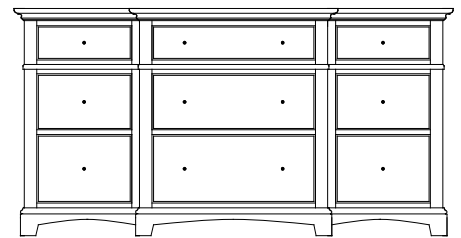

**HM-1856 Dresser**  
69½"w 36½"h 21½"d  
w/9 drawers

Suggested Mirrors:

**MI-1870 Mirror**  
40"h 52"w

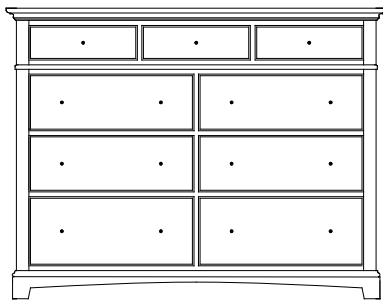

**HM-1857 Tall Dresser**  
60½"w 46¼"h 21½"d  
w/9 drawers

Suggested Mirrors:

**MI-1872 Mirror**  
32"h 43"w

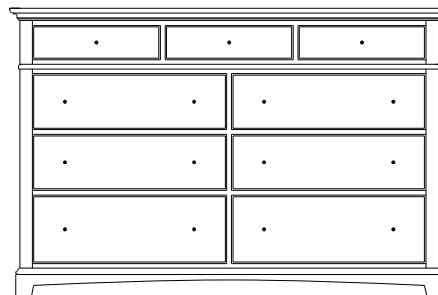

**HM-1858 Tall Dresser**  
70½"w 46¼"h 21½"d  
w/9 drawers

Suggested Mirrors:

**MI-1871 Mirror**  
32"h 52"w

# Hamilton Bed Frames



234-SR  
Storage  
Upgrade

shown with Regular Footboard

## Hamilton Bed

### Regular Footboard

Available  
with underbed  
storage options.

**HM-1880-K (King)**  
82 ¾" w 86 ½" l  
HB 60" h ■ FB 22" h

**HM-1880-Q (Queen)**  
67 ¼" w 86 ½" l  
HB 60" h ■ FB 22" h

**HM-1880-F (Full)**  
60 ½" w 81 ½" l  
HB 60" h ■ FB 22" h

**HM-1880-T (Twin)**  
45 ¼" w 81 ½" l  
HB 60" h ■ FB 22" h

### Low Footboard

**HM-1882-K (King)**  
82 ¾" w 84 ½" l  
HB 60" h ■ FB 14 ¾" h

**HM-1882-Q (Queen)**  
67 ¼" w 84 ½" l  
HB 60" h ■ FB 14 ¾" h

**HM-1882-F (Full)**  
60 ½" w 79 ½" l  
HB 60" h ■ FB 14 ¾" h

**HM-1882-T (Twin)**  
45 ¼" w 79 ½" l  
HB 60" h ■ FB 14 ¾" h

### Headboard Only

**HM-1885-HB-K (King)**  
60" high

**HM-1885-HB-Q (Queen)**  
60" high

**HM-1885-HB-F (Full)**  
60" high

**HM-1885-HB-T (Twin)**  
60" high

# Hamilton Storage Rail Upgrades

## 12<sup>3</sup>/<sub>4</sub>" From Floor to Box Spring

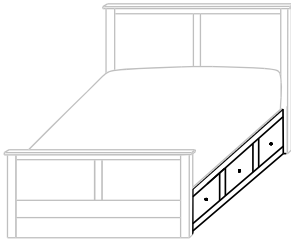

- With 3 drawers on each side
- 12<sup>3</sup>/<sub>4</sub>" from floor to Box Spring
- Inside drawer dimensions on all sizes  
9<sup>1</sup>/<sub>4</sub>"h 18<sup>7</sup>/<sub>8</sub>"w 22<sup>1</sup>/<sub>2</sub>"d

**532-SR-K** King – 6 drawers  
**532-SR-Q** Queen – 6 drawers  
**532-SR-F** Full – 6 drawers  
**532-SR-T** Twin – 3 drawers

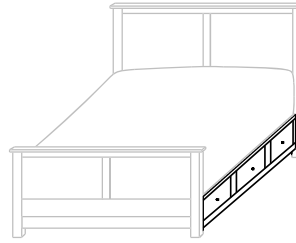

- With 3" Toe Kick
- With 3 drawers on each side
- 12<sup>3</sup>/<sub>4</sub>" from floor to Box Spring
- Inside drawer dimensions on all sizes  
6<sup>1</sup>/<sub>4</sub>"h 18<sup>7</sup>/<sub>8</sub>"w 22<sup>1</sup>/<sub>2</sub>"d

**234-SR-K** King – 6 drawers  
**234-SR-Q** Queen – 6 drawers  
**234-SR-F** Full – 6 drawers  
**234-SR-T** Twin – 3 drawers

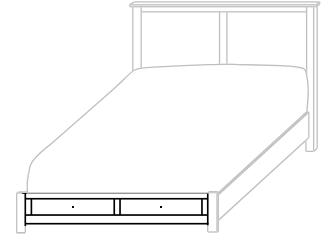

- 12<sup>3</sup>/<sub>4</sub>" from floor to Box Spring
- Inside drawer dimensions  
6<sup>1</sup>/<sub>4</sub>"h 22<sup>1</sup>/<sub>2</sub>"d  
 (King) 31"w      (Queen) 23<sup>1</sup>/<sub>4</sub>"w  
 (Full) 19<sup>5</sup>/<sub>8</sub>"w      (Twin) 29<sup>1</sup>/<sub>4</sub>"w

**685-FDS-K** King – 2 drawers  
**685-FDS-Q** Queen – 2 drawers  
**685-FDS-F** Full – 2 drawers  
**685-FDS-T** Twin – 1 drawer

## 19<sup>3</sup>/<sub>4</sub>" From Floor to Box Spring

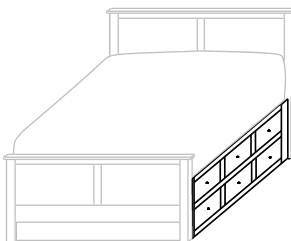

- With 6 drawers on each side
- Twin has 6 drawers on 1 side only
- 19<sup>3</sup>/<sub>4</sub>" from floor to Box Spring
- Inside drawer dimensions on all sizes  
6<sup>1</sup>/<sub>4</sub>"h 18<sup>7</sup>/<sub>8</sub>"w 22<sup>1</sup>/<sub>2</sub>"d

**654-SR-K** King – 12 drawers  
**654-SR-Q** Queen – 12 drawers  
**654-SR-F** Full – 12 drawers  
**654-SR-T** Twin – 6 drawers

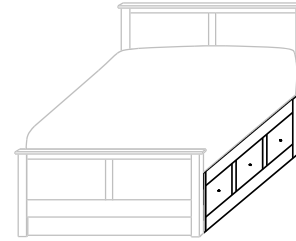

- With 3 drawers on each side
- 19<sup>3</sup>/<sub>4</sub>" from floor to Box Spring
- Inside drawer dimensions on all sizes  
10<sup>1</sup>/<sub>4</sub>"h 18<sup>7</sup>/<sub>8</sub>"w 22<sup>1</sup>/<sub>2</sub>"d

**325-SR-K** King – 6 drawers  
**325-SR-Q** Queen – 6 drawers  
**325-SR-F** Full – 6 drawers  
**325-SR-T** Twin – 3 drawers

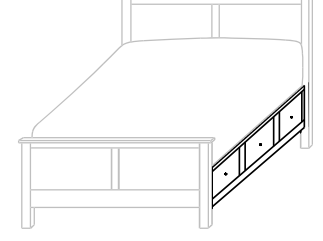

- With 7" Toe Kick
- With 3 drawers on each side
- 19<sup>3</sup>/<sub>4</sub>" from floor to Box Spring
- Inside drawer dimensions on all sizes  
9<sup>1</sup>/<sub>4</sub>"h 18<sup>7</sup>/<sub>8</sub>"w 22<sup>1</sup>/<sub>2</sub>"d

**236-SR-K** King – 6 drawers  
**236-SR-Q** Queen – 6 drawers  
**236-SR-F** Full – 6 drawers  
**236-SR-T** Twin – 3 drawers

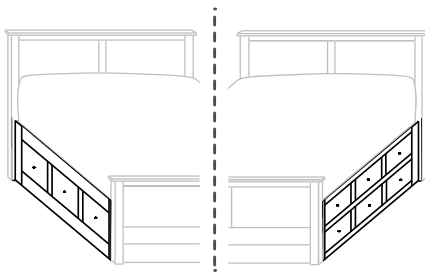

- With 3 drawers on one side and 6 drawers on other side
- 19<sup>3</sup>/<sub>4</sub>" from floor to Box Spring

**420-SR-K** King – 9 drawers  
**420-SR-Q** Queen – 9 drawers  
**420-SR-F** Full – 9 drawers  
 (Twin Not Available)

### Additional Upgrades

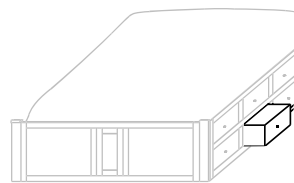

- With Step Stool Pullout in place of drawer

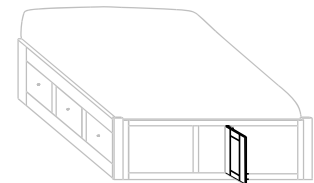

- With Door in Footboard to access area between rails





*Lew Modern*  
Bedroom Collection

# Lew Modern



## Lew Modern Bedroom Collection w/ Lew Modern Bed

- LM-2366Q Queen Bed
- LM-2316 Night Stand
- LM-2326 Chest
- LM-2330 Dresser
- MI-2470 Mirror

Shown above in **Walnut** with **Natural** and **K3489-MB Pulls**



- LM-2366Q Queen Bed
- LM-2316 Night Stand
- LM-2326 Chest
- LM-2330 Dresser
- MI-2470 Mirror

Shown in **Brown Maple**  
with **OCS-101 S-2** and  
**55276-BBZ Pulls**

### Standard Features:



55276-BBZ Pulls



Side-mount  
drawer slides

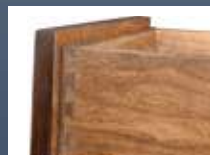

Stained poplar  
drawer boxes



Dovetailed bed slats

### Available Upgrades:

- Any Hardware on our Hardware options sheet
- Undermount full extension soft close slides [See Price List]

# Lew Modern Night Stands



**LM-2316**  
Night Stand shown

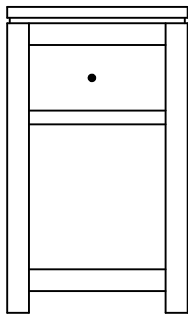

**LM-2311 Night Stand**  
16½"w 28"h 18"d  
w/1 drawer

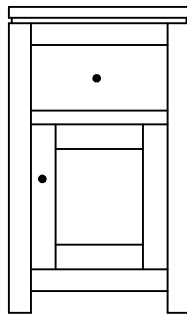

**LM-2312 Night Stand**  
16½"w 28"h 18"d  
w/1 drawer, 1 door

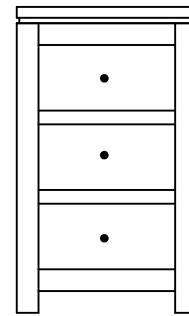

**LM-2313 Night Stand**  
16½"w 28"h 18"d  
w/3 drawers

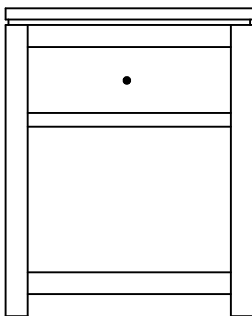

**LM-2314 Night Stand**  
22½"w 28"h 18"d  
w/1 drawer

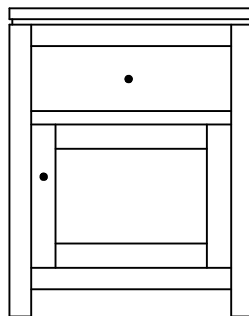

**LM-2315 Night Stand**  
22½"w 28"h 18"d  
w/1 drawer, 2 doors

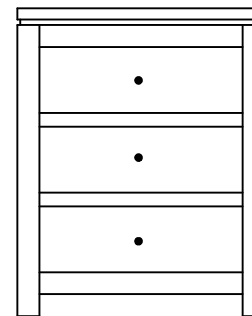

**LM-2316 Night Stand**  
22½"w 28"h 18"d  
w/3 drawers

# Low Modern Lingeries & Chests



**LM-2326**  
Chest shown

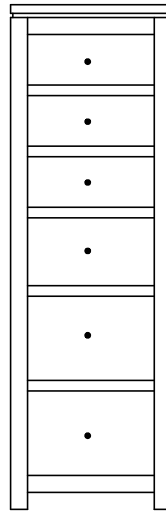

**LM-2317 Lingerie**  
19"w 59¾"h 19½"d  
w/6 drawers

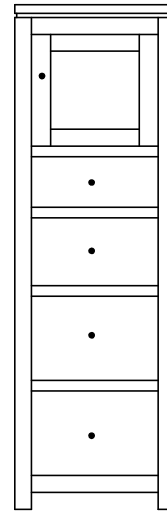

Available with  
mirror panel  
in door

**LM-2318 Lingerie**  
19"w 59¾"h 19½"d  
w/4 drawers, 1 wood door,  
1 adjustable shelf

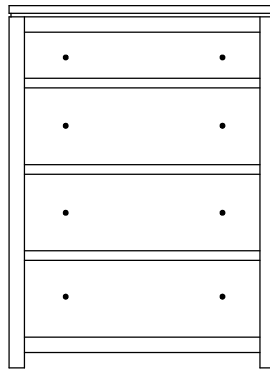

**LM-2326 Chest**  
34¾"w 47¼"h 19½"d  
w/4 drawers

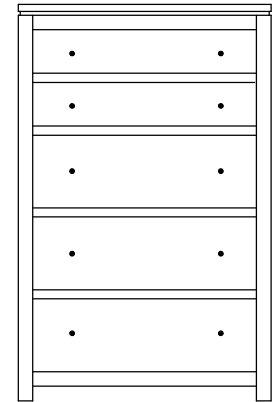

**LM-2327 Chest**  
34¾"w 54½"h 19½"d  
w/5 drawers

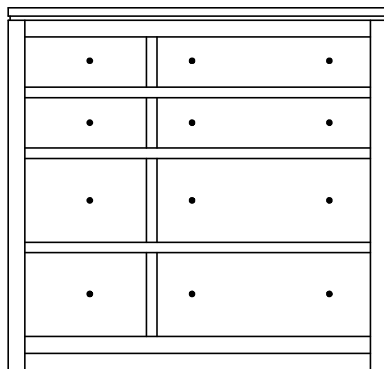

**LM-2341 Chest**  
45¼"w 43¼"h 19½"d  
w/8 drawers

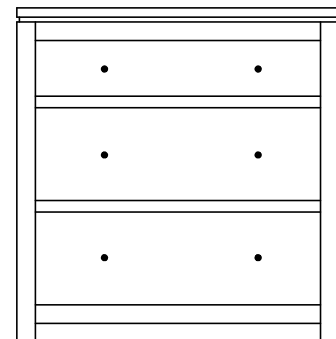

**LM-2349 Chest**  
34¾"w 36"h 19½"d  
w/3 drawers

# Low Modern Miscellaneous

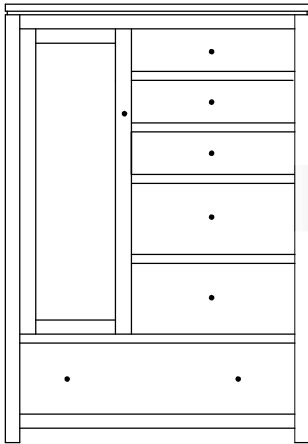

Option:  
Mirror on  
back of door

**LM-2328 Chifferobe**  
42¾"w 61¾"h 19½"d  
w/6 drawers, 1 door,  
2 adjustable shelves

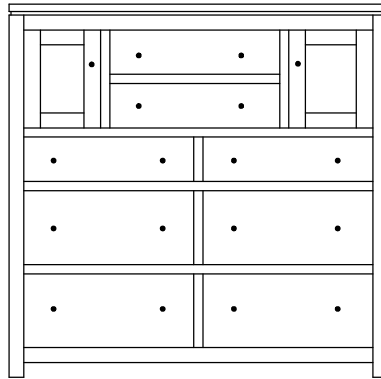

**LM-2347 His & Hers**  
51¼"w 50½"h 19½"d  
w/8 drawers, 2 doors

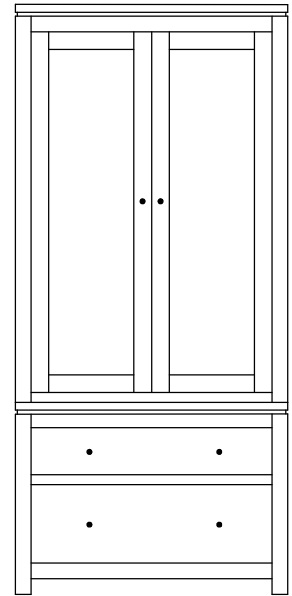

**LM-2362 Armoire**  
34¾"w 75½"h 19½"d  
w/2 drawers (Top  
drawer with divider),  
2 doors, 2 adjustable  
shelves & closet rod

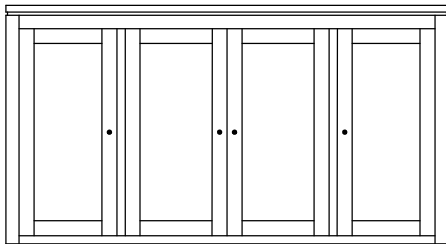

**LM-2359 Mule Chest Top**  
66¾"w 35¾"h 19½"d  
w/4 door, 6 adjustable shelves

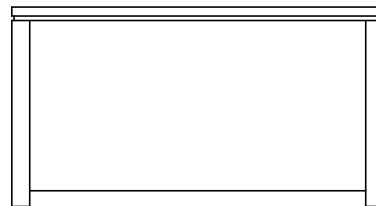

Available  
with aromatic  
cedar bottom

**LM-2335 Blanket Chest**  
40½"w 22¼"h 19½"d

# Low Modern Dressers



LM-2330 Dresser shown with MI-2470 Mirror

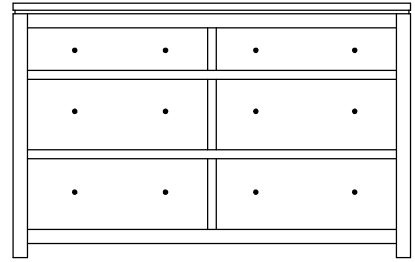

**LM-2330 Dresser**  
56¼"w 36"h 19½"d  
w/6 drawers

Suggested Mirrors:

**MI-2470**  
39¼"h 34"w

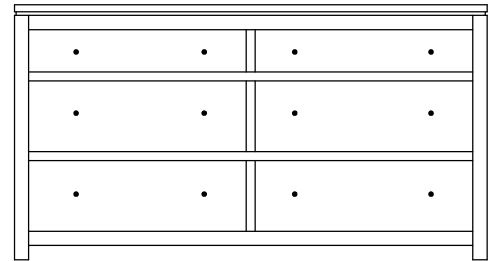

**LM-2331 Dresser**  
66¾"w 36"h 19½"d  
w/6 drawers

Suggested Mirrors:

**MI-2471**  
39¼"h 44"w

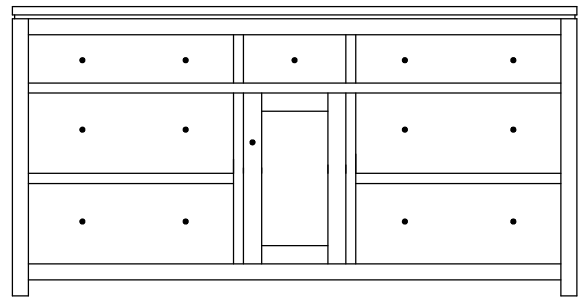

**LM-2332 Dresser**  
70"w 36"h 19½"d  
w/7 drawers, 1 door,  
1 adjustable shelf

Suggested Mirrors:

**MI-2471**  
39¼"h 44"w

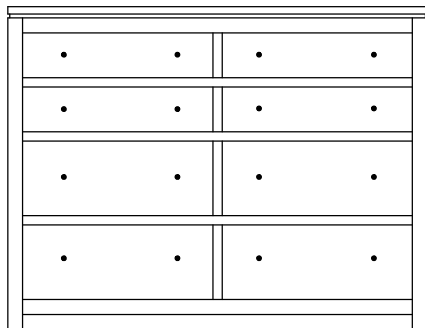

**LM-2343 Dresser**  
56¼"w 43¼"h 19½"d  
w/8 drawers

Suggested Mirrors:

**MI-2472**  
31¼"h 40"w

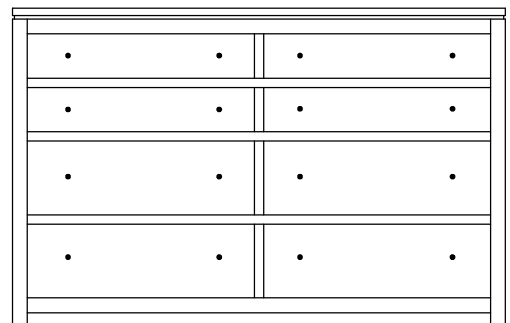

**LM-2344 Dresser**  
66¾"w 43¼"h 19½"d  
w/8 drawers

Suggested Mirrors:

**MI-2473**  
31¼"h 50"w

## Lew Modern Mirrors

---



Plain Mirror

**MI-2470 Mirror**  
39¼"high 34"wide

**MI-2471 Mirror**  
39¼"high 44"wide

**MI-2472 Mirror**  
31¼"high 40"wide

**MI-2473 Mirror**  
31¼"high 50"wide

# Lew Modern Bed Frames



Lew Modern Bed  
with Regular Footboard

## Bed Information

### Regular Footboard

**LM-2366-K** (King)  
84 $\frac{5}{8}$ "w 86 $\frac{1}{4}$ "l  
HB 46"h ■ FB 14 $\frac{3}{4}$ "h

**LM-2366-Q** (Queen)  
69"w 86 $\frac{1}{4}$ "l  
HB 46"h ■ FB 14 $\frac{3}{4}$ "h

**LM-2366-F** (Full)  
61 $\frac{7}{8}$ "w 81 $\frac{1}{4}$ "l  
HB 46"h ■ FB 14 $\frac{3}{4}$ "h

**LM-2366-T** (Twin)  
47"w 81 $\frac{1}{4}$ "l  
HB 46"h ■ FB 14 $\frac{3}{4}$ "h

### Headboard Only

**LM-2367-K-HB** (King)  
46" high

**LM-2367-Q-HB** (Queen)  
46" high

**LM-2367-F-HB** (Full)  
46" high

**LM-2367-T-HB** (Twin)  
46" high

# Lew Modern Storage Rail Upgrades

## 12<sup>3</sup>/<sub>4</sub>" From Floor to Box Spring

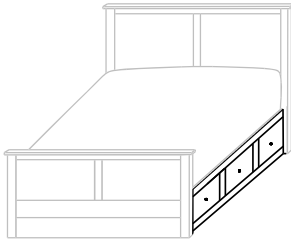

- With 3 drawers on each side
- 12<sup>3</sup>/<sub>4</sub>" from floor to Box Spring
- Inside drawer dimensions on all sizes  
9<sup>1</sup>/<sub>4</sub>"h 18<sup>7</sup>/<sub>8</sub>"w 22<sup>1</sup>/<sub>2</sub>"d

**532-SR-K** King – 6 drawers  
**532-SR-Q** Queen – 6 drawers  
**532-SR-F** Full – 6 drawers  
**532-SR-T** Twin – 3 drawers

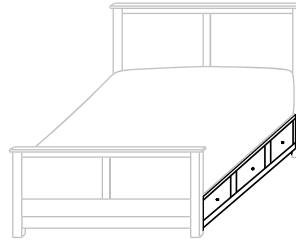

- With 3" Toe Kick
- With 3 drawers on each side
- 12<sup>3</sup>/<sub>4</sub>" from floor to Box Spring
- Inside drawer dimensions on all sizes  
6<sup>1</sup>/<sub>4</sub>"h 18<sup>7</sup>/<sub>8</sub>"w 22<sup>1</sup>/<sub>2</sub>"d

**234-SR-K** King – 6 drawers  
**234-SR-Q** Queen – 6 drawers  
**234-SR-F** Full – 6 drawers  
**234-SR-T** Twin – 3 drawers

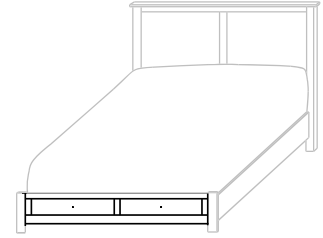

- 12<sup>3</sup>/<sub>4</sub>" from floor to Box Spring
- Inside drawer dimensions  
6<sup>1</sup>/<sub>4</sub>"h 22<sup>1</sup>/<sub>2</sub>"d  
 (King) 31" w      (Queen) 23<sup>1</sup>/<sub>4</sub>" w  
 (Full) 19<sup>5</sup>/<sub>8</sub>" w      (Twin) 29<sup>1</sup>/<sub>4</sub>" w

**685-FDS-K** King – 2 drawers  
**685-FDS-Q** Queen – 2 drawers  
**685-FDS-F** Full – 2 drawers  
**685-FDS-T** Twin – 1 drawer

## 19<sup>3</sup>/<sub>4</sub>" From Floor to Box Spring

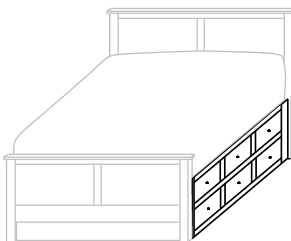

- With 6 drawers on each side
- Twin has 6 drawers on 1 side only
- 19<sup>3</sup>/<sub>4</sub>" from floor to Box Spring
- Inside drawer dimensions on all sizes  
6<sup>1</sup>/<sub>4</sub>"h 18<sup>7</sup>/<sub>8</sub>"w 22<sup>1</sup>/<sub>2</sub>"d

**654-SR-K** King – 12 drawers  
**654-SR-Q** Queen – 12 drawers  
**654-SR-F** Full – 12 drawers  
**654-SR-T** Twin – 6 drawers

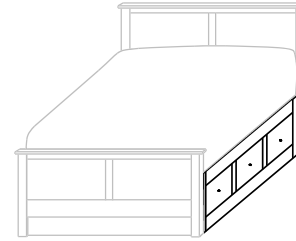

- With 3 drawers on each side
- 19<sup>3</sup>/<sub>4</sub>" from floor to Box Spring
- Inside drawer dimensions on all sizes  
10<sup>1</sup>/<sub>4</sub>"h 18<sup>7</sup>/<sub>8</sub>"w 22<sup>1</sup>/<sub>2</sub>"d

**325-SR-K** King – 6 drawers  
**325-SR-Q** Queen – 6 drawers  
**325-SR-F** Full – 6 drawers  
**325-SR-T** Twin – 3 drawers

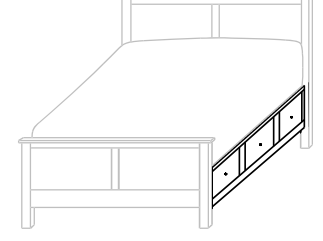

- With 7" Toe Kick
- With 3 drawers on each side
- 19<sup>3</sup>/<sub>4</sub>" from floor to Box Spring
- Inside drawer dimensions on all sizes  
9<sup>1</sup>/<sub>4</sub>"h 18<sup>7</sup>/<sub>8</sub>"w 22<sup>1</sup>/<sub>2</sub>"d

**236-SR-K** King – 6 drawers  
**236-SR-Q** Queen – 6 drawers  
**236-SR-F** Full – 6 drawers  
**236-SR-T** Twin – 3 drawers

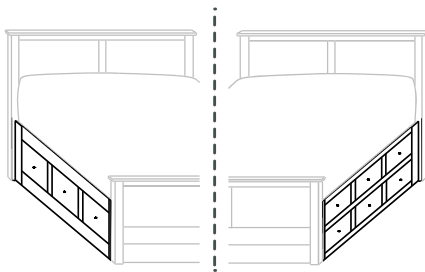

- With 3 drawers on one side and 6 drawers on other side
- 19<sup>3</sup>/<sub>4</sub>" from floor to Box Spring

**420-SR-K** King – 9 drawers  
**420-SR-Q** Queen – 9 drawers  
**420-SR-F** Full – 9 drawers  
 (Twin Not Available)

### Additional Upgrades

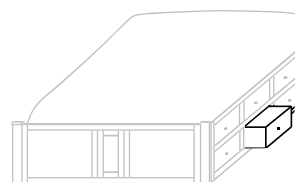

- With Step Stool Pullout in place of drawer

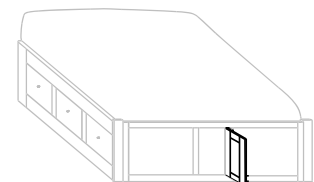

- With Door in Footboard to access area between rails





*Lewiston*  
Bedroom Collection

# Lewiston



## Lewiston Bedroom Collection w/Lewiston Bed

- LN-2366Q Queen Bed
- LN-2311 Night Stand
- LN-2326 Chest
- LN-2330 Dresser
- MI-2370 Mirror

Shown above in **Brown Maple** with **OCS-135 Driftwood Low Sheen** and **K773-VB** hardware

### Standard Features:



K773-VB pulls or K558-VB Pulls



Standard with side-mount drawer slides



Stained poplar dovetailed drawers



Dovetailed bed slats

### Available Upgrades:

- Any hardware on our Hardware Options Sheet
- Undermount soft close slides [See Price List]



- LN-2366Q Queen Bed
- LN-2311 Night Stand
- LN-2326 Chest
- LN-2330 Dresser
- MI-2370 Mirror

Shown in **Brown Maple** with **OCS-133 Tundra** and **K773-VB Hardware**

# Lewiston Night Stands



**LN-2311**  
Night Stand shown



Sliding top option available on all night stands  
(Hidden compartment w/Lock)

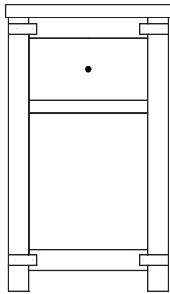

**LN-2311 Night Stand**  
17"w 27¾"h 18¼"d  
w/1 drawer

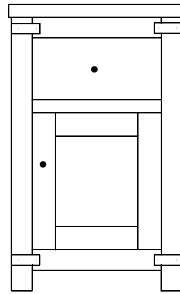

**LN-2312 Night Stand**  
17"w 27¾"h 18¼"d  
w/1 drawer, 1 door

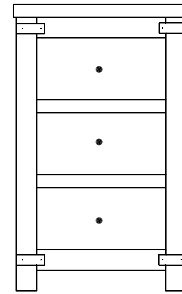

**LN-2313 Night Stand**  
17"w 27¾"h 18¼"d  
w/3 drawers

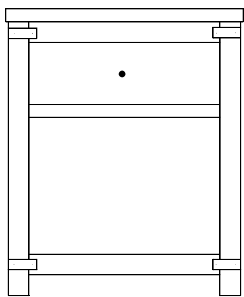

**LN-2314 Night Stand**  
23"w 27¾"h 18¼"d  
w/1 drawer

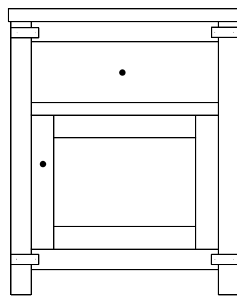

**LN-2315 Night Stand**  
23"w 27¾"h 18¼"d  
w/1 drawer, 1 door

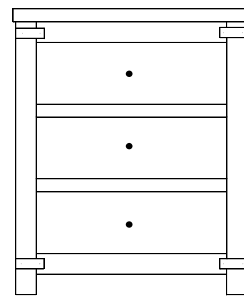

**LN-2316 Night Stand**  
23"w 27¾"h 18¼"d  
w/3 drawers

# Lewiston Lingeries & Chests



**LN-2326**  
Chest shown

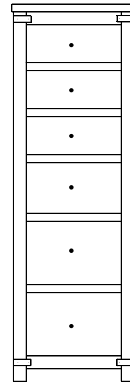

**LN-2317 Lingerie**  
19½"w 59½"h 19¾"d  
w/6 drawers

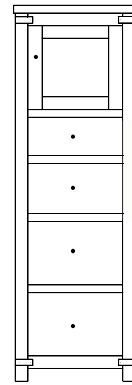

Available with  
mirror in  
door panel

**LN-2318 Lingerie**  
19½"w 59½"h 19¾"d  
w/4 drawers, 1 wood door,  
1 adjustable shelf

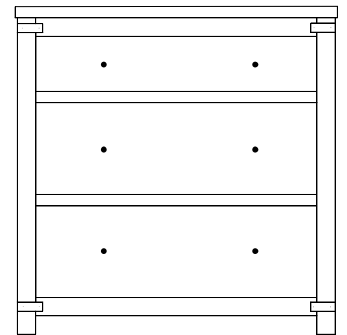

**LN-2349 Chest**  
35¼"w 35¾"h 19¾"d  
w/3 drawers

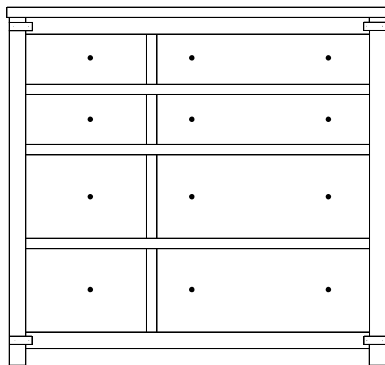

**LN-2341 Chest**  
45¾"w 43"h 19¾"d  
w/8 drawers

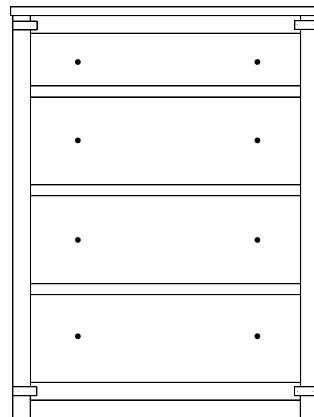

**LN-2326 Chest**  
35¼"w 47"h 19¾"d  
w/4 drawers

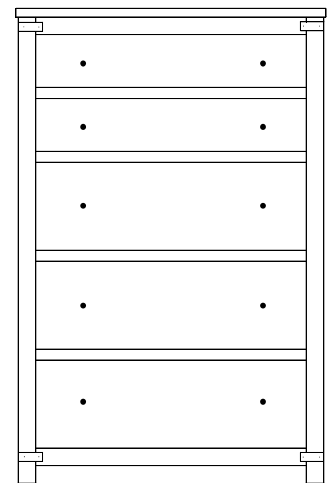

**LN-2327 Hi-Boy**  
35¼"w 54¼"h 19¾"d  
w/5 drawers

# Lewiston Miscellaneous

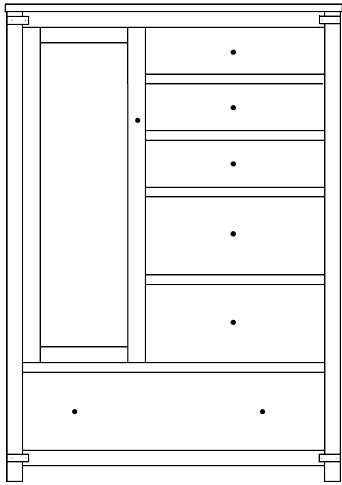

**LN-2328 Chifferobe**  
 43¼"w 61½"h 19¾"d  
 w/6 drawers, 1 door, 2 adj. shelves

Option:  
 Mirror on  
 back of door

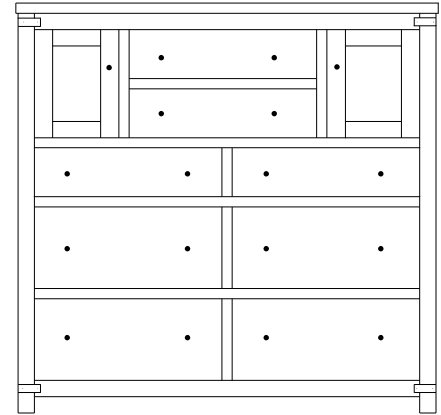

**LN-2347 His & Hers**  
 51¾"w 50¼"h 19¾"d  
 w/8 drawers, 2 doors

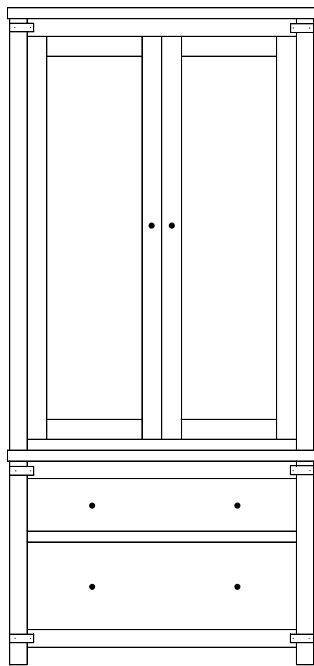

**LN-2362 Armoire**  
 35¼"w 75"h 19¾"d  
 w/2 drawers, (top drawer w/divider)  
 w/2 doors, 2 adj. shelves & closet rod

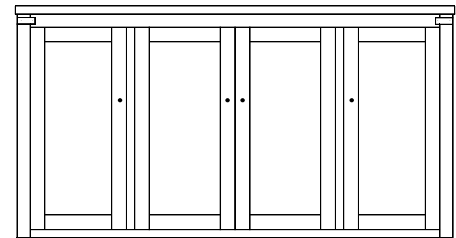

**LN-2359 Chest Top**  
 67¼"w 35½"h 19¾"d  
 w/4 doors & 6 adjustable shelves

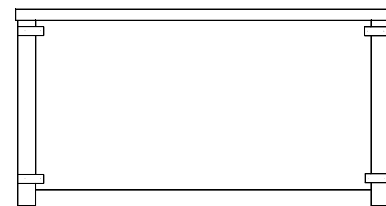

**LN-2335 Blanket Chest**  
 41"w 22"h 19¾"d

Available  
 with aromatic  
 cedar bottom

# Lewiston Dressers



LN-2330 Dresser shown with MI-2370 Mirror

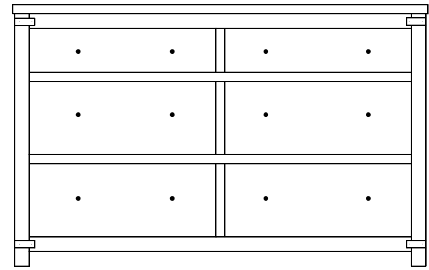

**LN-2330 Dresser**  
56 $\frac{3}{4}$ "w 35 $\frac{3}{4}$ "h 19 $\frac{3}{4}$ "d  
w/6 drawers

Suggested Mirrors:

**MI-2370 Mirror**  
40 $\frac{1}{2}$ "h 34 $\frac{1}{2}$ "w

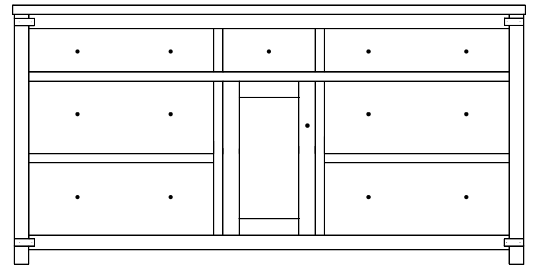

**LN-2332 Dresser**  
70 $\frac{1}{2}$ "w 35 $\frac{3}{4}$ "h 19 $\frac{3}{4}$ "d  
w/7 drawers, 1 door  
w/1 adjustable shelf

Suggested Mirrors:

**MI-2371 Mirror**  
40 $\frac{1}{2}$ "h 44 $\frac{1}{2}$ "w

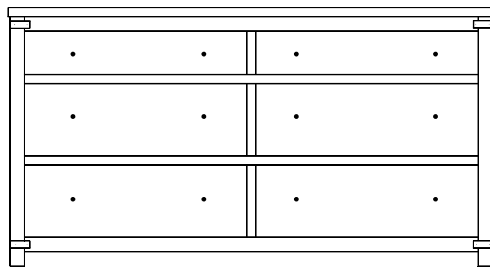

**LN-2331 Dresser**  
67 $\frac{1}{4}$ "w 35 $\frac{3}{4}$ "h 19 $\frac{3}{4}$ "d  
w/6 drawers

Suggested Mirrors:

**MI-2371 Mirror**  
40 $\frac{1}{2}$ "h 44 $\frac{1}{2}$ "w

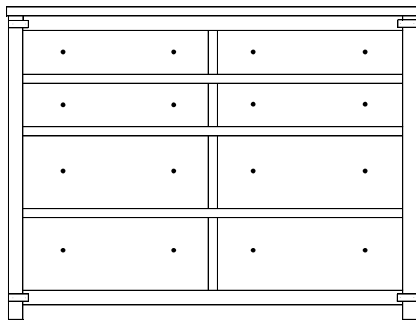

**LN-2343 Dresser**  
56 $\frac{3}{4}$ "w 43"h 19 $\frac{3}{4}$ "d  
w/8 drawers

Suggested Mirrors:

**MI-2372 Mirror**  
32 $\frac{1}{2}$ "h 40 $\frac{1}{2}$ "w

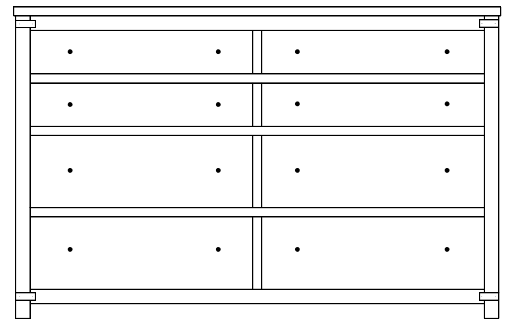

**LN-2344 Dresser**  
67 $\frac{1}{4}$ "w 43"h 19 $\frac{3}{4}$ "d  
w/8 drawers

Suggested Mirrors:

**MI-2373 Mirror**  
32 $\frac{1}{2}$ "h 50 $\frac{1}{2}$ "w



**MI-2370 Mirror**  
40½"h 34½"w

**MI-2371 Mirror**  
40½"h 44½"w

**MI-2372 Mirror**  
32½"h 40½"w

**MI-2373 Mirror**  
32½"h 50½"w

Plain Mirror

# Lewiston Bed Frames



shown with Low Footboard

## Lewiston Bed

### Regular Footboard

Available with underbed storage options.

**LN-2365-K (King)**  
80½"w 85½"l  
HB 54"h ■ FB 30¼"h

**LN-2365-Q (Queen)**  
64½"w 85½"l  
HB 54"h ■ FB 30¼"h

**LN-2365-F (Full)**  
57¾"w 80½"l  
HB 54"h ■ FB 30¼"h

**LN-2365-T (Twin)**  
42½"w 80½"l  
HB 54"h ■ FB 30¼"h

### Low Footboard

**LN-2366-K (King)**  
80½"w 84½"l  
HB 54"h ■ FB 16"h

**LN-2366-Q (Queen)**  
64½"w 84½"l  
HB 54"h ■ FB 16"h

**LN-2366-F (Full)**  
57¾"w 79½"l  
HB 54"h ■ FB 16"h

**LN-2366-T (Twin)**  
42½"w 79½"l  
HB 54"h ■ FB 16"h

### Headboard Only

**LN-2367K-HB (King)**  
54" high

**LN-2367Q-HB (Queen)**  
54" high

**LN-2367F-HB (Full)**  
54" high

**LN-2367T-HB (Twin)**  
54" high

# Lewiston Storage Rail Upgrades

## 12<sup>3</sup>/<sub>4</sub>" From Floor to Box Spring

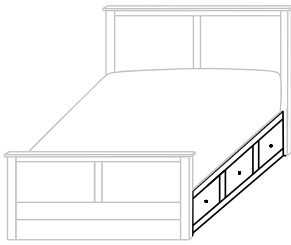

- With 3 drawers on each side
- 12<sup>3</sup>/<sub>4</sub>" from floor to Box Spring
- Inside drawer dimensions on all sizes  
9<sup>1</sup>/<sub>4</sub>"h 18<sup>7</sup>/<sub>8</sub>"w 22<sup>1</sup>/<sub>2</sub>"d

**532-SR-K** King – 6 drawers  
**532-SR-Q** Queen – 6 drawers  
**532-SR-F** Full – 6 drawers  
**532-SR-T** Twin – 3 drawers

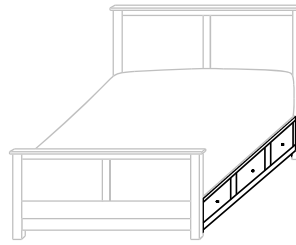

- With 3" Toe Kick
- With 3 drawers on each side
- 12<sup>3</sup>/<sub>4</sub>" from floor to Box Spring
- Inside drawer dimensions on all sizes  
6<sup>1</sup>/<sub>4</sub>"h 18<sup>7</sup>/<sub>8</sub>"w 22<sup>1</sup>/<sub>2</sub>"d

**234-SR-K** King – 6 drawers  
**234-SR-Q** Queen – 6 drawers  
**234-SR-F** Full – 6 drawers  
**234-SR-T** Twin – 3 drawers

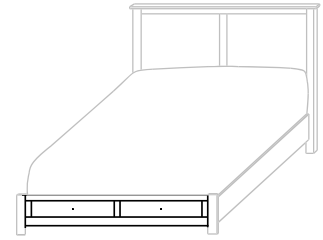

- 12<sup>3</sup>/<sub>4</sub>" from floor to Box Spring
- Inside drawer dimensions  
6<sup>1</sup>/<sub>4</sub>"h 22<sup>1</sup>/<sub>2</sub>"d  
(King) 31"w (Queen) 23<sup>1</sup>/<sub>4</sub>"w  
(Full) 19<sup>5</sup>/<sub>8</sub>"w (Twin) 29<sup>1</sup>/<sub>4</sub>"w

**685-FDS-K** King – 2 drawers  
**685-FDS-Q** Queen – 2 drawers  
**685-FDS-F** Full – 2 drawers  
**685-FDS-T** Twin – 1 drawer

## 19<sup>3</sup>/<sub>4</sub>" From Floor to Box Spring

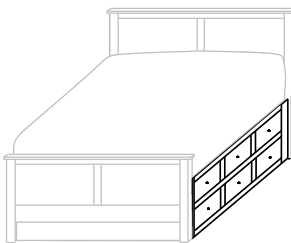

- With 6 drawers on each side
- Twin has 6 drawers on 1 side only
- 19<sup>3</sup>/<sub>4</sub>" from floor to Box Spring
- Inside drawer dimensions on all sizes  
6<sup>1</sup>/<sub>4</sub>"h 18<sup>7</sup>/<sub>8</sub>"w 22<sup>1</sup>/<sub>2</sub>"d

**654-SR-K** King – 12 drawers  
**654-SR-Q** Queen – 12 drawers  
**654-SR-F** Full – 12 drawers  
**654-SR-T** Twin – 6 drawers

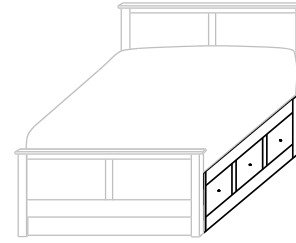

- With 3 drawers on each side
- 19<sup>3</sup>/<sub>4</sub>" from floor to Box Spring
- Inside drawer dimensions on all sizes  
10<sup>1</sup>/<sub>4</sub>"h 18<sup>7</sup>/<sub>8</sub>"w 22<sup>1</sup>/<sub>2</sub>"d

**325-SR-K** King – 6 drawers  
**325-SR-Q** Queen – 6 drawers  
**325-SR-F** Full – 6 drawers  
**325-SR-T** Twin – 3 drawers

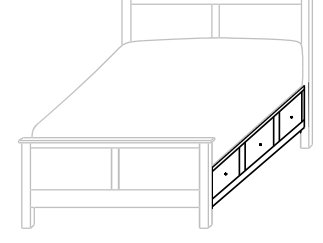

- With 7" Toe Kick
- With 3 drawers on each side
- 19<sup>3</sup>/<sub>4</sub>" from floor to Box Spring
- Inside drawer dimensions on all sizes  
9<sup>1</sup>/<sub>4</sub>"h 18<sup>7</sup>/<sub>8</sub>"w 22<sup>1</sup>/<sub>2</sub>"d

**236-SR-K** King – 6 drawers  
**236-SR-Q** Queen – 6 drawers  
**236-SR-F** Full – 6 drawers  
**236-SR-T** Twin – 3 drawers

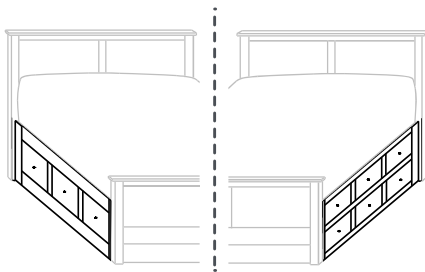

- With 3 drawers on one side and 6 drawers on other side
- 19<sup>3</sup>/<sub>4</sub>" from floor to Box Spring

**420-SR-K** King – 9 drawers  
**420-SR-Q** Queen – 9 drawers  
**420-SR-F** Full – 9 drawers  
 (Twin Not Available)

### Additional Upgrades

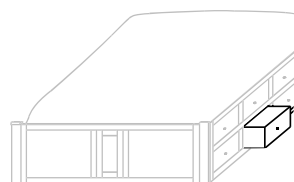

- With Step Stool Pullout in place of drawer

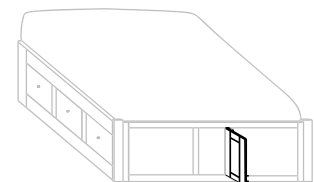

- With Door in Footboard to access area between rails





*Luellen*  
Bedroom Collection

# Luellen



## Luellen Bedroom Collection w/Lindenhurst Sleigh Bed

- LH-1522Q Queen Bed
- LE-311 Night Stand
- LE-362 Chest
- LE-330 Dresser
- MI-2130 Mirror

Shown above in **Brown Maple** with **OCS-113 Michaels** and **1½" Wood Knobs**

### Standard Features:



1½" Wood Knobs



Standard with side-mount drawer slides



Stained poplar drawer boxes



Dovetailed bed slats

### Available Upgrades:

- Any hardware on our Hardware Options Sheet
- Undermount soft close slides [See Price List]



- 2-LE-480T Twin Double Bow Beds
- 2-LE-313 Night Stands
- LE-365 Dresser
- MI-2130 Mirror

Shown in **Brown Maple** with **OCS-341 White** and **K810-MB Hardware**

# Luellen Night Stands



**LE-316**  
Night Stand shown



Sliding top option available on all night stands  
(Hidden compartment w/Lock)

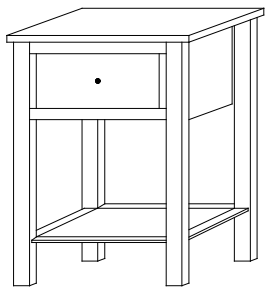

**TB-61 Night Stand**  
20¼"w 27½"h 19¼"d  
w/1 drawer

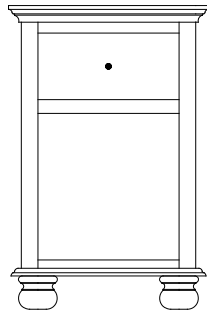

**LE-311 Night Stand**  
18"w 28"h 19"d  
w/1 drawer

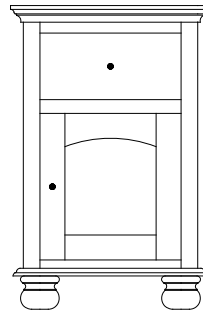

**LE-312 Night Stand**  
18"w 28"h 19"d  
w/1 drawer, 1 door

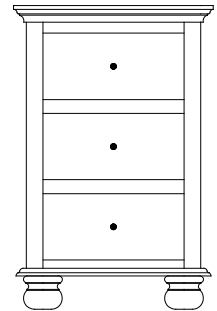

**LE-313 Night Stand**  
18"w 28"h 19"d  
w/3 drawers

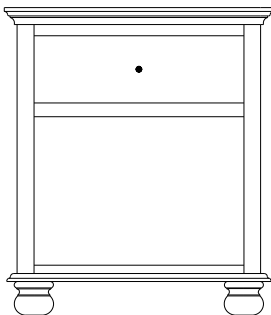

**LE-314 Night Stand**  
24"w 28"h 19"d  
w/1 drawer

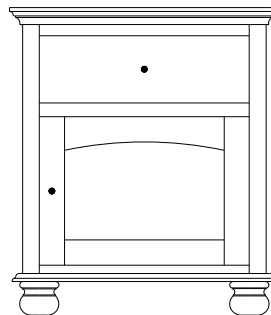

**LE-315 Night Stand**  
24"w 28"h 19"d  
w/1 drawer, 1 door



**LE-316 Night Stand**  
24"w 28"h 19"d  
w/3 drawers

# Luellen Lingeries & Chests



**LE-362**  
Chest shown

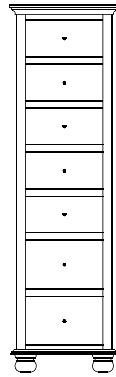

**LE-317 Lingerie**  
18"w 61"h 21"d  
w/7 drawers

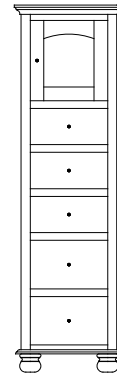

Available with  
mirror panel  
in door (LE-319)

**LE-318 Lingerie**  
18"w 61"h 21"d  
w/5 drawers, 1 wood door,  
1 adjustable shelf

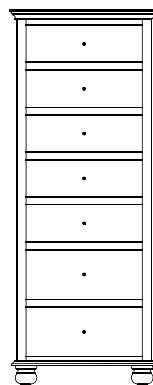

**LE-320 Lingerie**  
24"w 61"h 21"d  
w/7 drawers

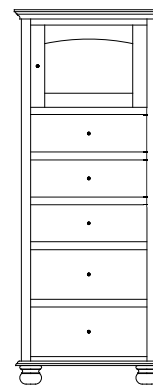

Available with  
mirror panel  
in door (LE-322)

**LE-321 Lingerie**  
24"w 61"h 21"d  
w/5 drawers, 1 wood door,  
1 adjustable shelf

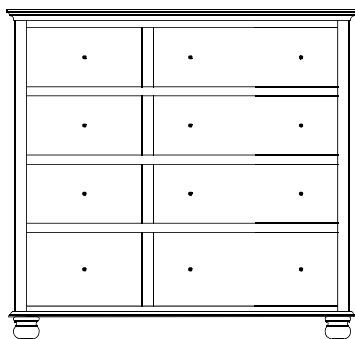

**LE-341 Chest**  
48"w 45 1/2"h 21"d  
w/8 drawers

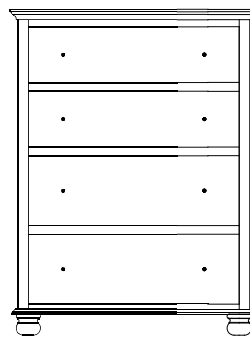

**LE-326 Chest**  
36"w 47 1/2"h 21"d  
w/4 drawers

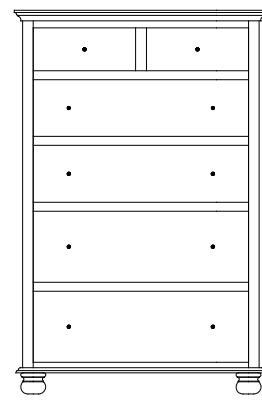

**LE-362 Chest**  
36"w 54 1/2"h 21"d  
w/6 drawers

# Luellen Miscellaneous

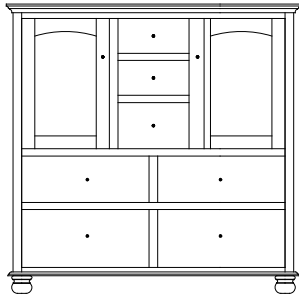

**LE-347 His & Hers**  
51¼"w 50½"h 21"d  
w/7 drawers, 2 doors, 2 adj. shelves

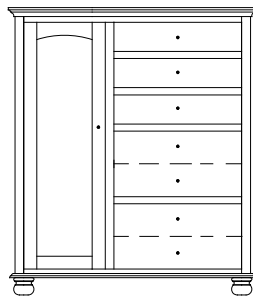

**LE-328 Chifferobe**  
43¼"w 50"h 21"d  
w/5 drawers, 1 door, 2 adj. shelves

Option:  
Mirror on  
back of door

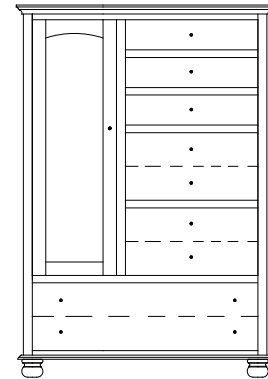

**LE-329 Chifferobe**  
43¼"w 62½"h 21"d  
w/6 drawers, 1 door, 2 adj. shelves

Option:  
Mirror on  
back of door

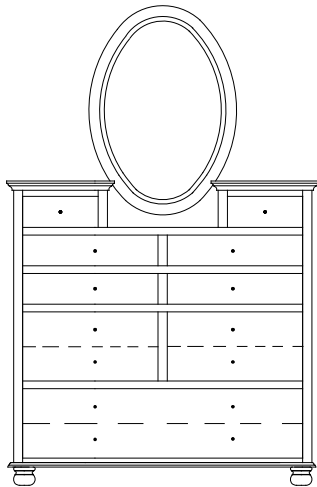

**LE-336 Studio w/Mirror**  
51¼"w 80½"h 21"d  
w/9 drawers

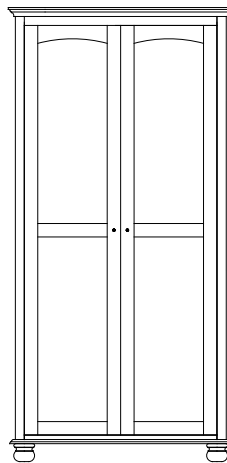

**LE-359 Wardrobe**  
39"w 76½"h 25½"d  
w/2 doors, closet rod

Option:  
Adjustable shelves  
  
Full width drawer  
inside doors in  
bottom of unit

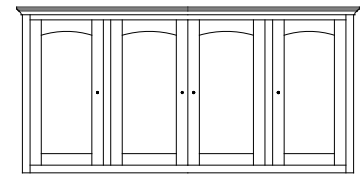

**LE-35 Mule Chest Top**  
68¾"w 35½"h 21½"d  
w/4 doors & 4 adjustable shelves

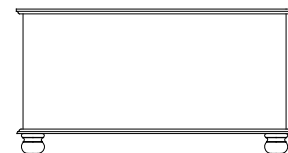

**LE-364 Blanket Chest**  
42"w 22"h 21½"d

Available  
with aromatic  
cedar bottom

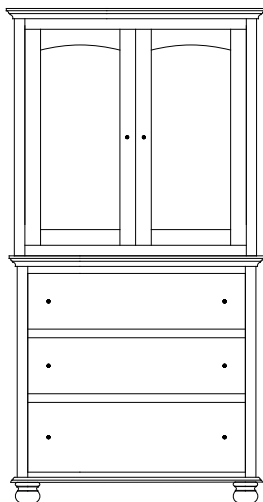

**LE-25 Armoire Top**  
37"w 35½"h 21½"d  
w/2 doors, 2 adj. shelves  
w/1 wire hole in back

**LE-323 Armoire Base**  
36"w 35½"h 21"d  
w/3 drawers

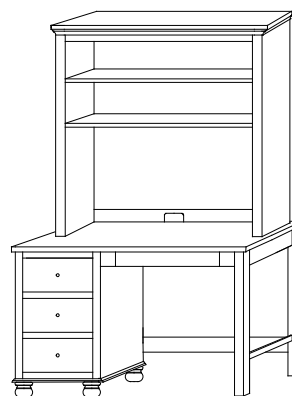

**LE-397 Study Carrel**  
48"w 42"h 13"d  
w/2 adjustable shelves

**LE-399 Student Desk**  
48"w 29½"h 22½"d  
w/3 drawers  
w/1 pencil drawer

Upgrades available on student desk:

Keyboard slideout instead of pencil drawer  
File drawer instead of bottom 2 drawers

# Luellen Dressers



**LE-330 Dresser** shown with **MI-2130 Mirror**

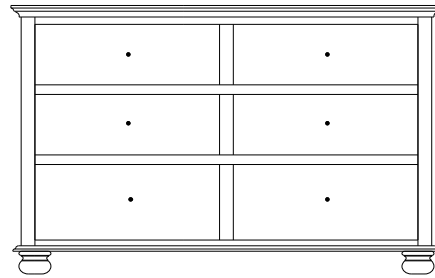

**LE-330 Dresser**  
57¼"w 36"h 21"d  
w/6 drawers

Suggested Mirrors:

**MI-2131 Mirror**  
40"h 46"w

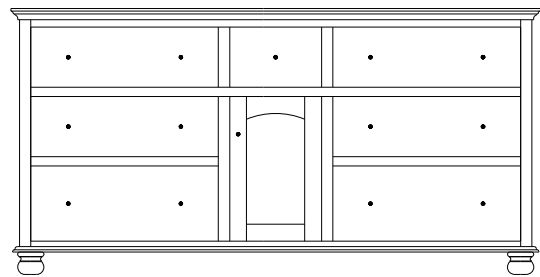

**LE-332 Dresser**  
71"w 36"h 21"d  
w/7 drawers, 1 door

Suggested Mirrors:

**MI-2131 Mirror**  
40"h 46"w

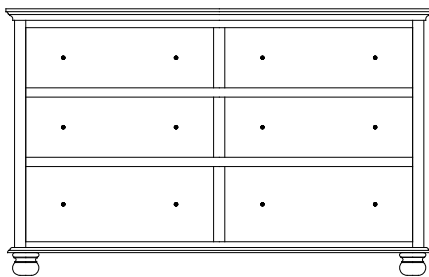

**LE-331 Dresser**  
67¾"w 36"h 21"d  
w/6 drawers

Suggested Mirrors:

**MI-2131 Mirror**  
40"h 46"w

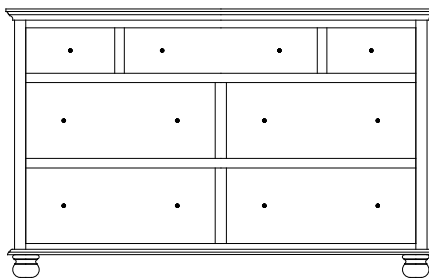

**LE-363 Dresser**  
57¼"w 36"h 21"d  
w/7 drawers

Suggested Mirrors:

**MI-2130 Mirror**  
40"h 36"w

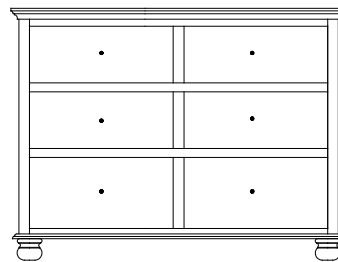

**LE-365 Dresser**  
47¾"w 34"h 21"d  
w/6 drawers

Suggested Mirrors:

**MI-2130 Mirror**  
40"h 36"w

# Luellen Dressers

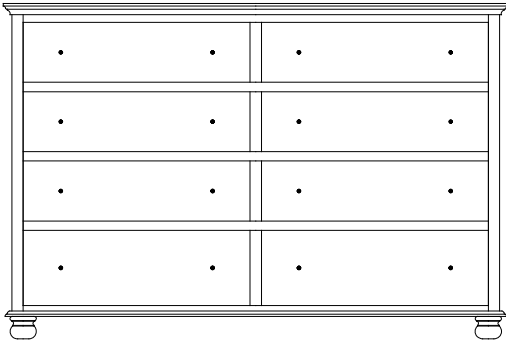

**LE-334 Dresser**  
67 3/4"w 47 1/4"h 21"d  
w/8 drawers

Suggested Mirrors:

**MI-2133 Mirror**  
32"h 52"w

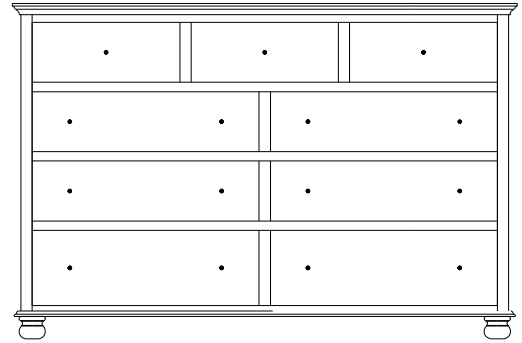

**LE-344 Dresser**  
67 3/4"w 45 1/4"h 21"d  
w/9 drawers

Suggested Mirrors:

**MI-2133 Mirror**  
32"h 52"w

# Luellen Mirror



Beveled Mirror

**MI-2130 Mirror**  
40"high 36"wide

**MI-2131 Mirror**  
40"high 46"wide

**MI-2132 Mirror**  
32"high 42"wide

**MI-2133 Mirror**  
32"high 52"wide

# Luellen Bed Frames



shown with Regular Footboard



shown with Regular Footboard

## Lindenhurst Sleigh Bed

### Regular Footboard

Available with underbed storage options.

**LH-1520-K (King)**  
79 1/8" w 89 1/4" l  
HB 48" h ■ FB 30" h

**LH-1520-Q (Queen)**  
63 5/8" w 89 1/4" l  
HB 48" h ■ FB 30" h

**LH-1520-F (Full)**  
56 3/8" w 85 1/4" l  
HB 48" h ■ FB 30" h

**LH-1520-T (Twin)**  
41 5/8" w 85 1/4" l  
HB 48" h ■ FB 30" h

### Low Footboard

**LH-1522-K (King)**  
79 1/8" w 89 3/8" l  
HB 48" h ■ FB 14 3/4" h

**LH-1522-Q (Queen)**  
63 5/8" w 89 3/8" l  
HB 48" h ■ FB 14 3/4" h

**LH-1522-F (Full)**  
56 3/8" w 84 3/8" l  
HB 48" h ■ FB 14 3/4" h

**LH-1522-T (Twin)**  
41 5/8" w 84 3/8" l  
HB 48" h ■ FB 14 3/4" h

### Headboard Only

**LH-1525-HB-K (King)**  
48" high

**LH-1525-HB-Q (Queen)**  
48" high

**LH-1525-HB-F (Full)**  
48" high

**LH-1525-HB-T (Twin)**  
48" high

## Double Bow Bed

### Regular Footboard

Available with underbed storage options.

**LE-480-K (King)**  
79 1/4" w 87" l  
HB 47 1/4" h ■ FB 36 1/4" h

**LE-480-Q (Queen)**  
63 1/2" w 87" l  
HB 47 1/4" h ■ FB 36 1/4" h

**LE-480-F (Full)**  
57" w 82" l  
HB 47 1/4" h ■ FB 36 1/4" h

**LE-480-T (Twin)**  
41 1/4" w 82" l  
HB 47 1/4" h ■ FB 36 1/4" h

### Low Footboard

**LE-479-K (King)**  
79 1/4" w 85 3/4" l  
HB 47 1/4" h ■ FB 14 3/4" h

**LE-479-Q (Queen)**  
63 1/2" w 85 3/4" l  
HB 47 1/4" h ■ FB 14 3/4" h

**LE-479-F (Full)**  
57" w 80 3/4" l  
HB 47 1/4" h ■ FB 14 3/4" h

**LE-479-T (Twin)**  
41 1/4" w 80 3/4" l  
HB 47 1/4" h ■ FB 14 3/4" h

### Headboard Only

**LE-478-HB-K (King)**  
47 1/4" high

**LE-478-HB-Q (Queen)**  
47 1/4" high

**LE-478-HB-F (Full)**  
47 1/4" high

**LE-478-HB-T (Twin)**  
47 1/4" high

# Luellen Storage Rail Upgrades

## 12<sup>3</sup>/<sub>4</sub>" From Floor to Box Spring

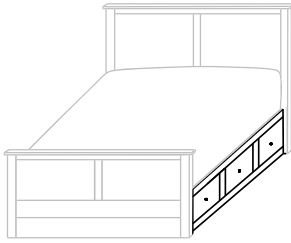

- With 3 drawers on each side
- 12<sup>3</sup>/<sub>4</sub>" from floor to Box Spring
- Inside drawer dimensions on all sizes  
9<sup>1</sup>/<sub>4</sub>"h 18<sup>7</sup>/<sub>8</sub>"w 22<sup>1</sup>/<sub>2</sub>"d

**532-SR-K** King – 6 drawers  
**532-SR-Q** Queen – 6 drawers  
**532-SR-F** Full – 6 drawers  
**532-SR-T** Twin – 3 drawers

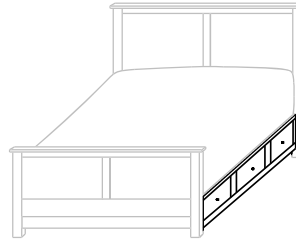

- With 3" Toe Kick
- With 3 drawers on each side
- 12<sup>3</sup>/<sub>4</sub>" from floor to Box Spring
- Inside drawer dimensions on all sizes  
6<sup>1</sup>/<sub>4</sub>"h 18<sup>7</sup>/<sub>8</sub>"w 22<sup>1</sup>/<sub>2</sub>"d

**234-SR-K** King – 6 drawers  
**234-SR-Q** Queen – 6 drawers  
**234-SR-F** Full – 6 drawers  
**234-SR-T** Twin – 3 drawers

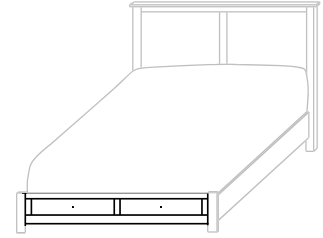

- 12<sup>3</sup>/<sub>4</sub>" from floor to Box Spring
- Inside drawer dimensions  
6<sup>1</sup>/<sub>4</sub>"h 22<sup>1</sup>/<sub>2</sub>"d  
 (King) 31"w      (Queen) 23<sup>1</sup>/<sub>4</sub>"w  
 (Full) 19<sup>5</sup>/<sub>8</sub>"w      (Twin) 29<sup>1</sup>/<sub>4</sub>"w

**685-FDS-K** King – 2 drawers  
**685-FDS-Q** Queen – 2 drawers  
**685-FDS-F** Full – 2 drawers  
**685-FDS-T** Twin – 1 drawer

## 19<sup>3</sup>/<sub>4</sub>" From Floor to Box Spring

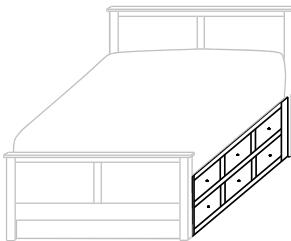

- With 6 drawers on each side
- Twin has 6 drawers on 1 side only
- 19<sup>3</sup>/<sub>4</sub>" from floor to Box Spring
- Inside drawer dimensions on all sizes  
6<sup>1</sup>/<sub>4</sub>"h 18<sup>7</sup>/<sub>8</sub>"w 22<sup>1</sup>/<sub>2</sub>"d

**654-SR-K** King – 12 drawers  
**654-SR-Q** Queen – 12 drawers  
**654-SR-F** Full – 12 drawers  
**654-SR-T** Twin – 6 drawers

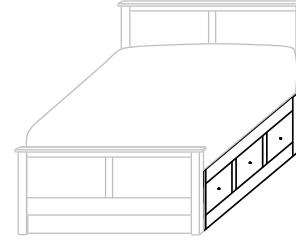

- With 3 drawers on each side
- 19<sup>3</sup>/<sub>4</sub>" from floor to Box Spring
- Inside drawer dimensions on all sizes  
10<sup>1</sup>/<sub>4</sub>"h 18<sup>7</sup>/<sub>8</sub>"w 22<sup>1</sup>/<sub>2</sub>"d

**325-SR-K** King – 6 drawers  
**325-SR-Q** Queen – 6 drawers  
**325-SR-F** Full – 6 drawers  
**325-SR-T** Twin – 3 drawers

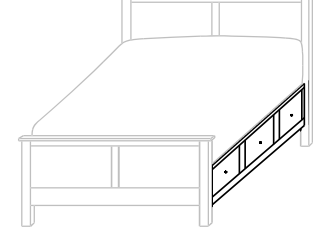

- With 7" Toe Kick
- With 3 drawers on each side
- 19<sup>3</sup>/<sub>4</sub>" from floor to Box Spring
- Inside drawer dimensions on all sizes  
9<sup>1</sup>/<sub>4</sub>"h 18<sup>7</sup>/<sub>8</sub>"w 22<sup>1</sup>/<sub>2</sub>"d

**236-SR-K** King – 6 drawers  
**236-SR-Q** Queen – 6 drawers  
**236-SR-F** Full – 6 drawers  
**236-SR-T** Twin – 3 drawers

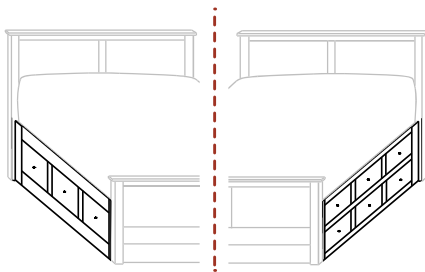

- With 3 drawers on one side and 6 drawers on other side
- 19<sup>3</sup>/<sub>4</sub>" from floor to Box Spring

**420-SR-K** King – 9 drawers  
**420-SR-Q** Queen – 9 drawers  
**420-SR-F** Full – 9 drawers  
 (Twin Not Available)

### Additional Upgrades

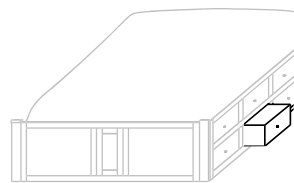

- With Step Stool Pullout in place of drawer

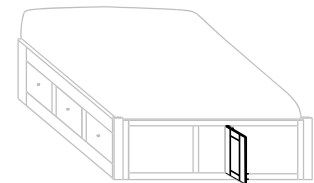

- With Door in Footboard to access area between rails





*Manhattan*  
Bedroom Collection

# Manhattan



## Manhattan Bedroom Collection w/Manhattan Panel Bed

- MH-2175Q Queen Bed
- MH-2154 Dresser
- MH-2140 Night Stand
- MI-1665 Mirror
- MH-2150 Chest

Shown above in **Rustic Hickory** with **OCS-117 Asbury/OCS-110 Medium** and **4424-ORB Pulls & 4425-ORB Knob**

### Standard Features:



4424-ORB Pulls &  
4425-ORB Knobs



Standard with side-  
mount drawer slides



Stained poplar  
drawer boxes



Reclaimed Barnwood  
Tops and 2 Tone

### Available Upgrades:

- Any hardware on our Hardware Options Sheet
- Undermount soft close slides [See Price List]



- MH-2171Q Manhattan Bed
- MH-2145 Night Stand
- MH-2150 Chest
- MH-2157 Dresser
- MI-2067 Mirror

Shown in **Rustic Hickory**  
with **OCS-117 Asbury / OCS-110**  
**Medium** and **4424-ORB Pulls**  
and **4425-ORB Knobs**

# Manhattan Night Stands



**MH-2145**  
Night Stand shown



Sliding top option available on all night stands  
(Hidden compartment w/Lock)

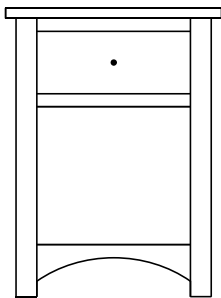

**MH-2140 Night Stand**  
20 $\frac{3}{4}$ "w 27 $\frac{3}{4}$ "h 17 $\frac{1}{2}$ "d  
w/1 drawer

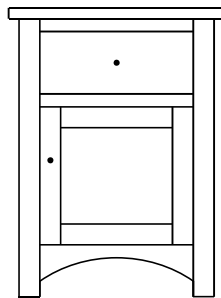

**MH-2141 Night Stand**  
20 $\frac{3}{4}$ "w 27 $\frac{3}{4}$ "h 17 $\frac{1}{2}$ "d  
w/1 drawer, 1 door

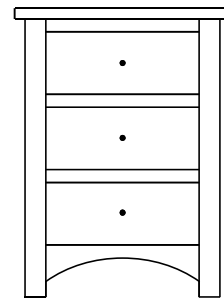

**MH-2142 Night Stand**  
20 $\frac{3}{4}$ "w 27 $\frac{3}{4}$ "h 17 $\frac{1}{2}$ "d  
w/3 drawers

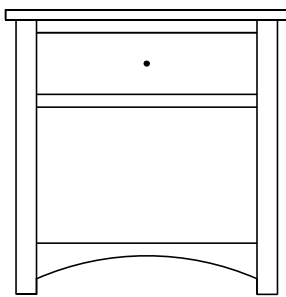

**MH-2143 Night Stand**  
27 $\frac{1}{2}$ "w 27 $\frac{3}{4}$ "h 17 $\frac{1}{2}$ "d  
w/1 drawer

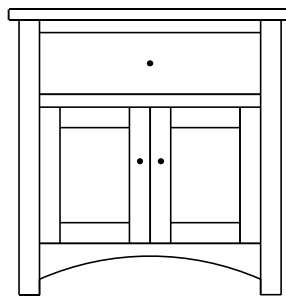

**MH-2144 Night Stand**  
27 $\frac{1}{2}$ "w 27 $\frac{3}{4}$ "h 17 $\frac{1}{2}$ "d  
w/1 drawer, 2 doors

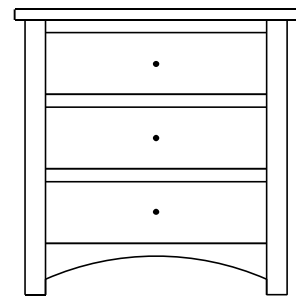

**MH-2145 Night Stand**  
27 $\frac{1}{2}$ "w 27 $\frac{3}{4}$ "h 17 $\frac{1}{2}$ "d  
w/3 drawers

# Manhattan Lingeries & Chests



**MH-2150**  
Chest shown

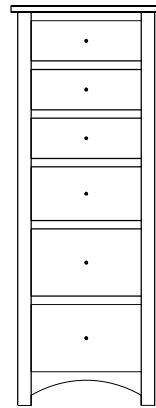

**MH-2146 Lingerie**  
22<sup>3</sup>/<sub>8</sub>"w 59<sup>1</sup>/<sub>2</sub>"h 21<sup>1</sup>/<sub>2</sub>"d  
w/6 drawers

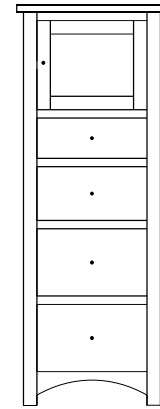

Available with  
mirror panel  
in door

**MH-2147 Lingerie**  
22<sup>3</sup>/<sub>8</sub>"w 59<sup>1</sup>/<sub>2</sub>"h 21<sup>1</sup>/<sub>2</sub>"d  
w/4 drawers, 1 wood door,  
1 adjustable shelf

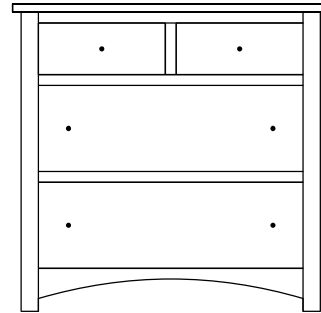

**MH-2149 Chest**  
36<sup>3</sup>/<sub>4</sub>"w 35<sup>3</sup>/<sub>4</sub>"h 21<sup>1</sup>/<sub>2</sub>"d  
w/4 drawers

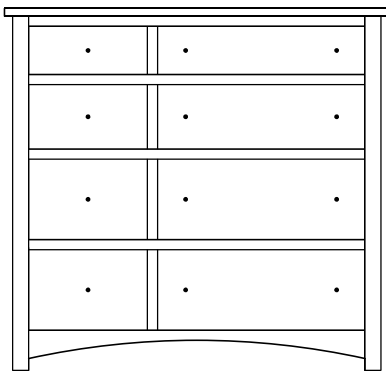

**MH-2148 Chest**  
47<sup>3</sup>/<sub>4</sub>"w 45"h 21<sup>1</sup>/<sub>2</sub>"d  
w/8 drawers

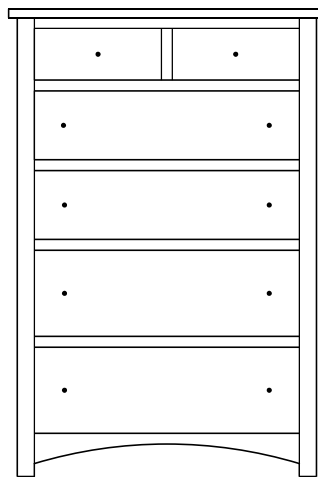

**MH-2150 Chest**  
36<sup>3</sup>/<sub>4</sub>"w 54<sup>1</sup>/<sub>4</sub>"h 21<sup>1</sup>/<sub>2</sub>"d  
w/6 drawers

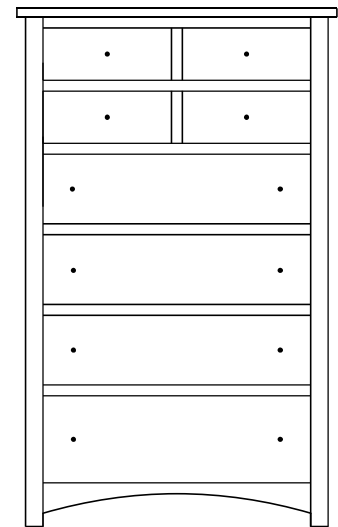

**MH-2151 Hi-Boy**  
36<sup>3</sup>/<sub>4</sub>"w 59<sup>1</sup>/<sub>2</sub>"h 21<sup>1</sup>/<sub>2</sub>"d  
w/8 drawers

# Manhattan Miscellaneous

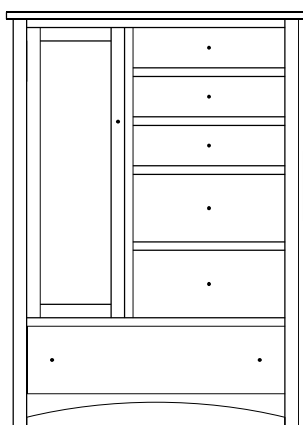

Option:  
Mirror on  
back of door

**MH-2152 Chifferobe**  
44 1/4"w 61 1/2"h 21 1/2"d  
w/6 drawers, 1 door, 2 adj. shelves

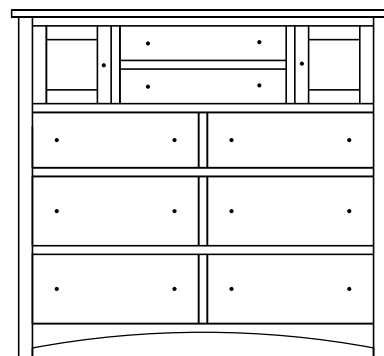

**MH-2153 His & Hers**  
55 1/4"w 50 1/4"h 21 1/2"d  
w/8 drawers, 2 doors

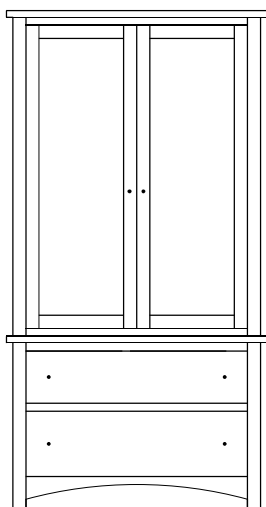

**MH-2162 Armoire**  
40"w 76 1/4"h 21 1/2"d  
w/2 drawers, (top drawer w/divider)  
w/2 doors, 2 adj. shelves & closet rod

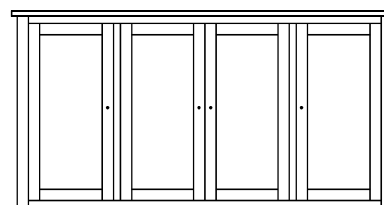

**MH-2159 Mule Chest Top**  
68 3/4"w 35"h 21 1/2"d  
w/4 doors & 6 adjustable shelves

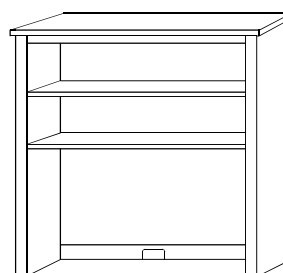

**MH-2197 Study Carrel**  
48"w 42"h 13"d  
w/2 adjustable shelves

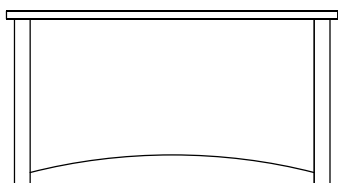

**MH-2135 Blanket Chest**  
42"w 22"h 21 1/2"d

Available  
with aromatic  
cedar bottom

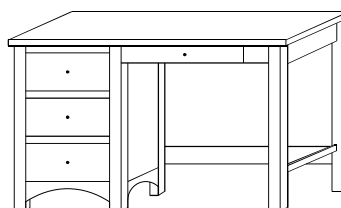

**MH-2199 Student Desk**  
48"w 29 1/4"h 22 1/2"d  
w/3 drawers  
w/1 pencil drawer

Upgrades available on student desk:

Keyboard slideout instead of pencil drawer  
File drawer instead of bottom 2 drawers

# Manhattan Dressers



MH-2158 Dresser shown with MI-1668 Mirror

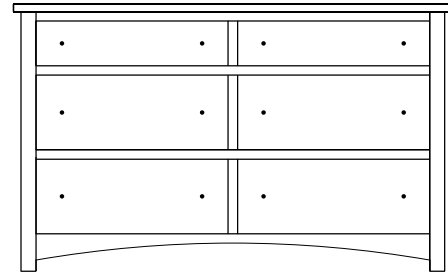

**MH-2154 Dresser**  
58 $\frac{3}{4}$ "w 35 $\frac{3}{4}$ "h 21 $\frac{1}{2}$ "d  
w/6 drawers

Suggested Mirrors:

**MI-1665 Mirror**  
40"h 36"w

**MI-2065 Mirror**  
40"h 36"w

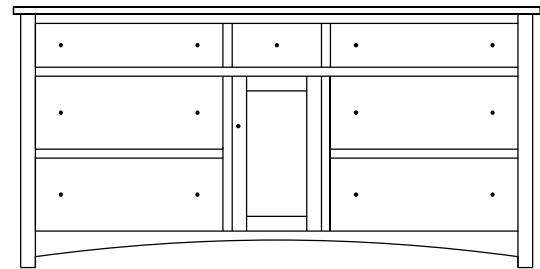

**MH-2156 Dresser**  
72 $\frac{1}{4}$ "w 35 $\frac{3}{4}$ "h 21 $\frac{1}{2}$ "d  
w/7 drawers, 1 door,  
1 adjustable shelf

Suggested Mirrors:

**MI-1666 Mirror**  
40"h 46"w

**MI-2066 Mirror**  
40"h 46"w

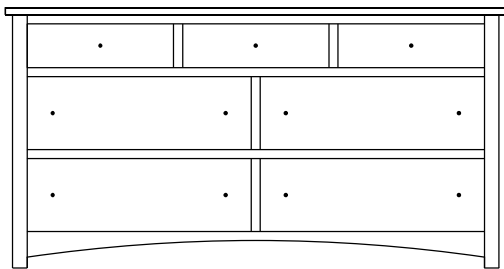

**MH-2155 Dresser**  
68 $\frac{3}{4}$ "w 35 $\frac{3}{4}$ "h 21 $\frac{1}{2}$ "d  
w/7 drawers

Suggested Mirrors:

**MI-1666 Mirror**  
40"h 46"w

**MI-2066 Mirror**  
40"h 46"w

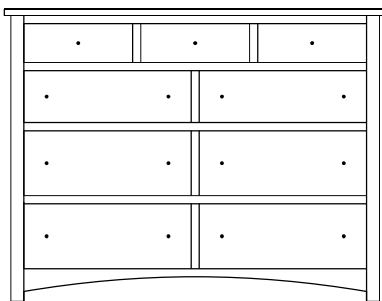

**MH-2157 Dresser**  
58 $\frac{3}{4}$ "w 45"h 21 $\frac{1}{2}$ "d  
w/9 drawers

Suggested Mirrors:

**MI-1667 Mirror**  
32"h 42"w

**MI-2067 Mirror**  
32"h 42"w

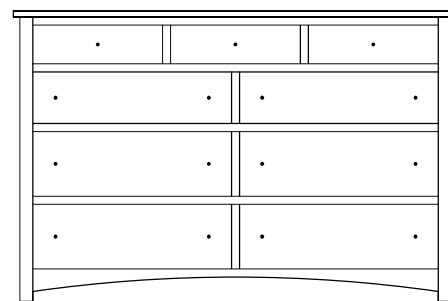

**MH-2158 Dresser**  
68 $\frac{3}{4}$ "w 45"h 21 $\frac{1}{2}$ "d  
w/9 drawers

Suggested Mirrors:

**MI-1668 Mirror**  
32"h 52"w

# Manhattan Mirrors



Beveled Mirror

**MI-1665 Mirror**  
40"high 36"wide

**MI-1666 Mirror**  
40"high 46"wide

**MI-1667 Mirror**  
32"high 42"wide

**MI-1668 Mirror**  
32"high 52"wide



Beveled Mirror

**MI-2065 Mirror**  
40"high 36"wide

**MI-2066 Mirror**  
40"high 46"wide

**MI-2067 Mirror**  
32"high 42"wide

**MI-2068 Mirror**  
32"high 52"wide

# Manhattan Bed Frames



shown with Regular Footboard



shown with Regular Footboard

## Manhattan Curved Bed

Available with underbed storage options.

### Regular Footboard

**MH-2171-K (King)**  
82½" w 87" l  
HB 59¼" h ■ FB 30¼" h

**MH-2171-Q (Queen)**  
66½" w 87" l  
HB 57¼" h ■ FB 30¼" h

**MH-2171-F (Full)**  
59¾" w 82" l  
HB 55¾" h ■ FB 30¼" h

**MH-2171-T (Twin)**  
44½" w 82" l  
HB 53¾" h ■ FB 30¼" h

### Low Footboard

**MH-2178-K (King)**  
82½" w 85¾" l  
HB 59¼" h ■ FB 14¾" h

**MH-2178-Q (Queen)**  
66½" w 85¾" l  
HB 57¼" h ■ FB 14¾" h

**MH-2178-F (Full)**  
59¾" w 80¾" l  
HB 55¾" h ■ FB 14¾" h

**MH-2178-T (Twin)**  
44½" w 80¾" l  
HB 53¾" h ■ FB 14¾" h

### Headboard Only

**MH-2170K-HB (King)**  
59¼" high

**MH-2170Q-HB (Queen)**  
57¼" high

**MH-2170F-HB (Full)**  
55¾" high

**MH-2170T-HB (Twin)**  
53¾" high

## Manhattan Panel Bed

Available with underbed storage options.

### Regular Footboard

**MH-2174-K (King)**  
82½" w 86½" l  
HB 53" h ■ FB 30" h

**MH-2174-Q (Queen)**  
66½" w 86½" l  
HB 53" h ■ FB 30" h

**MH-2174-F (Full)**  
59¾" w 81½" l  
HB 53" h ■ FB 30" h

**MH-2174-T (Twin)**  
44½" w 81½" l  
HB 53" h ■ FB 30" h

### Low Footboard

**MH-2175-K (King)**  
82½" w 85½" l  
HB 53" h ■ FB 14¾" h

**MH-2175-Q (Queen)**  
66½" w 85½" l  
HB 53" h ■ FB 14¾" h

**MH-2175-F (Full)**  
59¾" w 80½" l  
HB 53" h ■ FB 14¾" h

**MH-2175-T (Twin)**  
44½" w 80½" l  
HB 53" h ■ FB 14¾" h

### Headboard Only

**MH-2173K-HB (King)**  
53" high

**MH-2173Q-HB (Queen)**  
53" high

**MH-2173F-HB (Full)**  
53" high

**MH-2173T-HB (Twin)**  
53" high

# Manhattan Storage Rail Upgrades

## 12<sup>3</sup>/<sub>4</sub>" From Floor to Box Spring

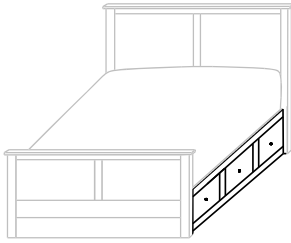

- With 3 drawers on each side
- 12<sup>3</sup>/<sub>4</sub>" from floor to Box Spring
- Inside drawer dimensions on all sizes  
9<sup>1</sup>/<sub>4</sub>"h 18<sup>7</sup>/<sub>8</sub>"w 22<sup>1</sup>/<sub>2</sub>"d

**532-SR-K** King – 6 drawers  
**532-SR-Q** Queen – 6 drawers  
**532-SR-F** Full – 6 drawers  
**532-SR-T** Twin – 3 drawers

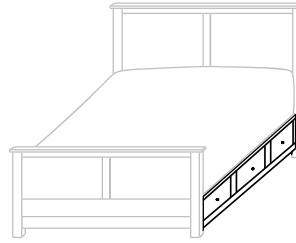

- With 3" Toe Kick
- With 3 drawers on each side
- 12<sup>3</sup>/<sub>4</sub>" from floor to Box Spring
- Inside drawer dimensions on all sizes  
6<sup>1</sup>/<sub>4</sub>"h 18<sup>7</sup>/<sub>8</sub>"w 22<sup>1</sup>/<sub>2</sub>"d

**234-SR-K** King – 6 drawers  
**234-SR-Q** Queen – 6 drawers  
**234-SR-F** Full – 6 drawers  
**234-SR-T** Twin – 3 drawers

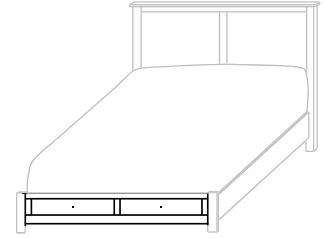

- 12<sup>3</sup>/<sub>4</sub>" from floor to Box Spring
- Inside drawer dimensions  
6<sup>1</sup>/<sub>4</sub>"h 22<sup>1</sup>/<sub>2</sub>"d  
(King) 31" w      (Queen) 23<sup>1</sup>/<sub>4</sub>" w  
(Full) 19<sup>5</sup>/<sub>8</sub>" w      (Twin) 29<sup>1</sup>/<sub>4</sub>" w

**685-FDS-K** King – 2 drawers  
**685-FDS-Q** Queen – 2 drawers  
**685-FDS-F** Full – 2 drawers  
**685-FDS-T** Twin – 1 drawer

## 19<sup>3</sup>/<sub>4</sub>" From Floor to Box Spring

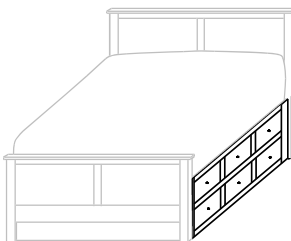

- With 6 drawers on each side
- Twin has 6 drawers on 1 side only
- 19<sup>3</sup>/<sub>4</sub>" from floor to Box Spring
- Inside drawer dimensions on all sizes  
6<sup>1</sup>/<sub>4</sub>"h 18<sup>7</sup>/<sub>8</sub>"w 22<sup>1</sup>/<sub>2</sub>"d

**654-SR-K** King – 12 drawers  
**654-SR-Q** Queen – 12 drawers  
**654-SR-F** Full – 12 drawers  
**654-SR-T** Twin – 6 drawers

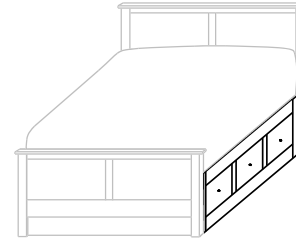

- With 3 drawers on each side
- 19<sup>3</sup>/<sub>4</sub>" from floor to Box Spring
- Inside drawer dimensions on all sizes  
10<sup>1</sup>/<sub>4</sub>"h 18<sup>7</sup>/<sub>8</sub>"w 22<sup>1</sup>/<sub>2</sub>"d

**325-SR-K** King – 6 drawers  
**325-SR-Q** Queen – 6 drawers  
**325-SR-F** Full – 6 drawers  
**325-SR-T** Twin – 3 drawers

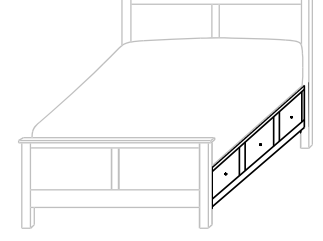

- With 7" Toe Kick
- With 3 drawers on each side
- 19<sup>3</sup>/<sub>4</sub>" from floor to Box Spring
- Inside drawer dimensions on all sizes  
9<sup>1</sup>/<sub>4</sub>"h 18<sup>7</sup>/<sub>8</sub>"w 22<sup>1</sup>/<sub>2</sub>"d

**236-SR-K** King – 6 drawers  
**236-SR-Q** Queen – 6 drawers  
**236-SR-F** Full – 6 drawers  
**236-SR-T** Twin – 3 drawers

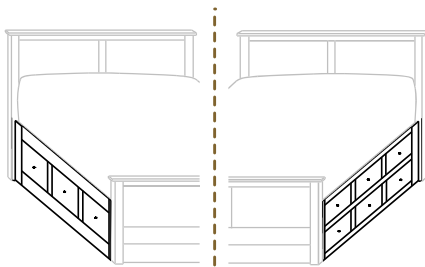

- With 3 drawers on one side and 6 drawers on other side
- 19<sup>3</sup>/<sub>4</sub>" from floor to Box Spring

**420-SR-K** King – 9 drawers  
**420-SR-Q** Queen – 9 drawers  
**420-SR-F** Full – 9 drawers  
 (Twin Not Available)

### Additional Upgrades

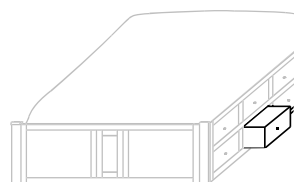

- With Step Stool Pullout in place of drawer

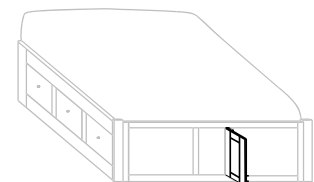

- With Door in Footboard to access area between rails





*Monticello*  
Bedroom Collection

# Low Modern



## Monticello Bedroom Collection w/ Monticello Bed

- MO-1410Q Queen Bed
- MO-1445 Night Stand
- MO-1463 Chest
- MO-1458 Dresser
- MI-1433 Mirror

Shown above in **Brown Maple** with **NC-1400 Weather-wood & 55276-BBR Pulls**

### Standard Features:



55276-BBR Pulls



Side-mount drawer slides



Stained poplar drawer boxes



Dovetailed bed slats

### Available Upgrades:

- Any Hardware on our Hardware options sheet
- Undermount full extension soft close slides [See Price List]



- MO-1410Q Queen Bed
- MO-1445 Night Stand
- MO-1463 Chest
- MO-1458 Dresser
- MI-1433 Mirror

Shown in **Brown Maple** with **NC-1400 Weather-wood & 55276-BBR Pulls**

# Monticello Night Stands



**MO-1445**  
Night Stand shown



Sliding top option available on all night stands  
(Hidden compartment w/Lock)

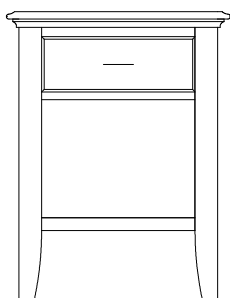

**MO-1440 Night Stand**  
22¼"w 28¾"h 17¾"d  
w/1 drawer

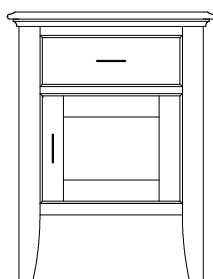

**MO-1441 Night Stand**  
22¼"w 28¾"h 17¾"d  
w/1 drawer, 1 door

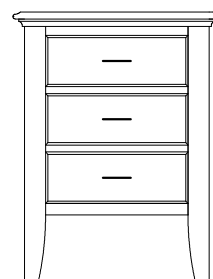

**MO-1442 Night Stand**  
22¼"w 28¾"h 17¾"d  
w/3 drawers

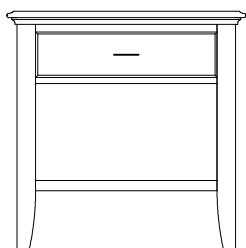

**MO-1443 Night Stand**  
29"w 28¾"h 17¾"d  
w/1 drawer

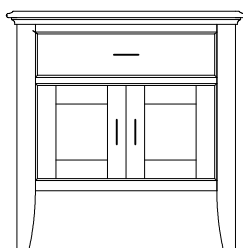

**MO-1444 Night Stand**  
29"w 28¾"h 17¾"d  
w/1 drawer, 2 doors

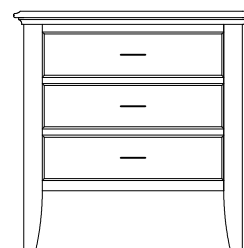

**MO-1445 Night Stand**  
29"w 28¾"h 17¾"d  
w/3 drawers

# Monticello Lingeries & Chests



**MO-1463**  
Chest shown

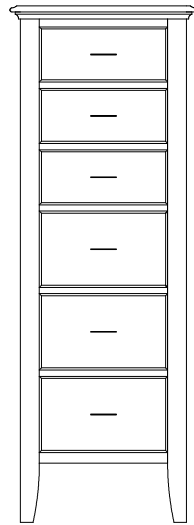

**MO-1446 Lingerie**  
22¼"w 61"h 22¾"d  
w/6 drawers

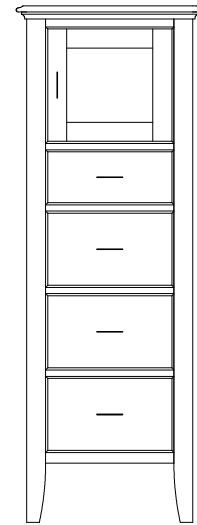

Available with  
mirror panel  
in door

**MO-1447 Lingerie**  
22¼"w 61"h 22¾"d  
w/4 drawers, 1 wood door,  
1 adjustable shelf



**MO-1448 Chest**  
49¼"w 46"h 21¾"d  
w/8 drawers



**MO-1449 Chest**  
38¼"w 36¾"h 21¾"d  
w/4 drawers

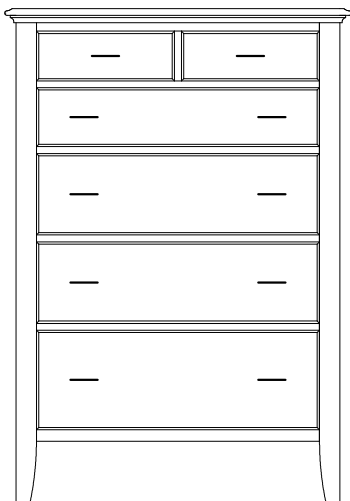

**MO-1450 Chest**  
38¼"w 54¾"h 21¾"d  
w/6 drawers

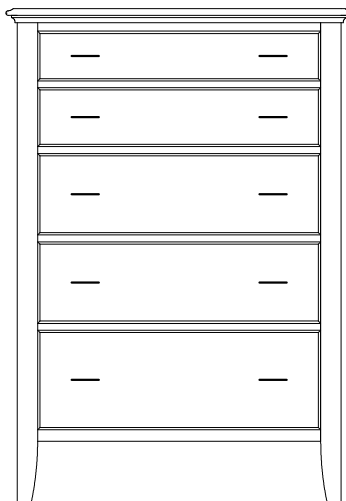

**MO-1463 Chest**  
38¼"w 54¾"h 21¾"d  
w/5 drawers

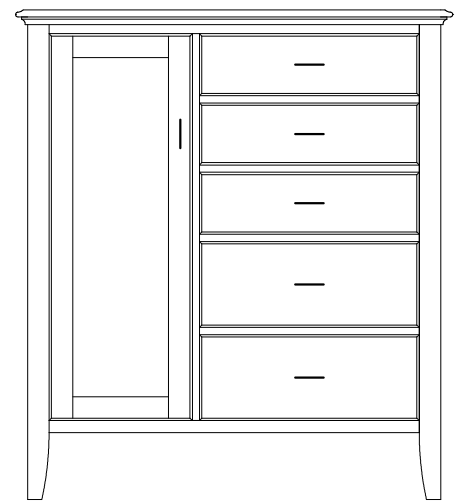

**MO-1451 Chest**  
45¾"w 51¼"h 21¾"d  
w/5 drawers, 1 door,  
2 adjustable shelves

# Monticello Miscellaneous

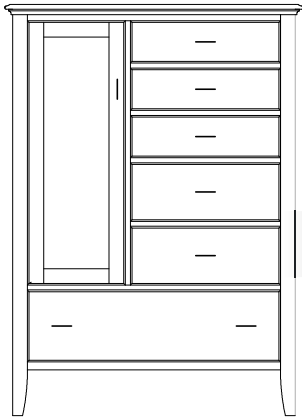

**MO-1452 Chifferobe**  
45¾"w 63"h 21¾"d  
w/6 drawers, 1 door,  
2 adjustable shelves

Option:  
Mirror on  
back of door

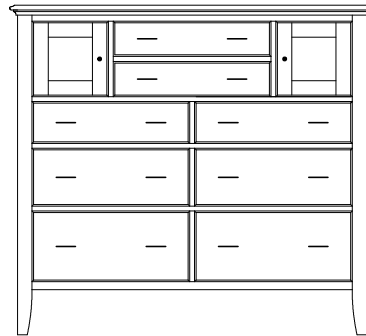

**MO-1453 His & Hers**  
56¾"w 51¼"h 21¾"d  
w/8 drawers, 2 doors

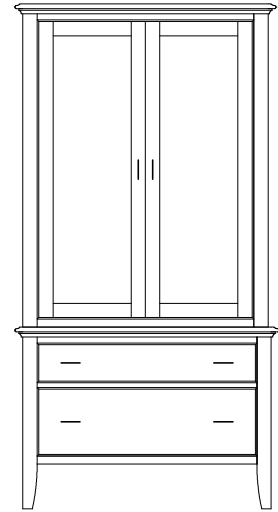

**MO-1462 Armoire**  
41"w 79¼"h 21¾"d  
w/2 drawers (Top  
drawer with divider),  
2 doors, 2 adjustable  
shelves & closet rod

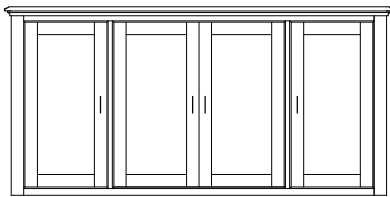

**MO-1459 Mule Chest Top**  
70¼"w 34"h 21¾"d  
w/4 door, 6 adjustable shelves

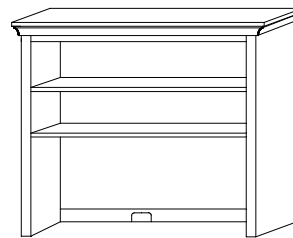

**MO-1497 Study Carrel**  
49½"w 42"h 13¾"d  
2 adjustable shelves

Available  
with aromatic  
cedar bottom

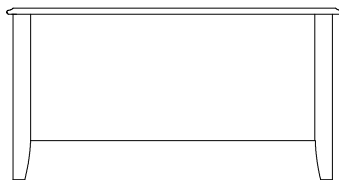

**MO-1439 Blanket Chest**  
43"w 22"h 23"d

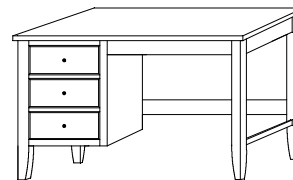

**MO-1499 Student Desk**  
48"w 28¾"h 28"d  
w/3 drawers, 1 pencil drawer

Upgrades available on student desk:  
Keyboard slideout instead of pencil drawer  
File drawer instead of bottom 2 drawers

# Monticello Dressers



MO-1458 Dresser shown with MI-1443 Mirror

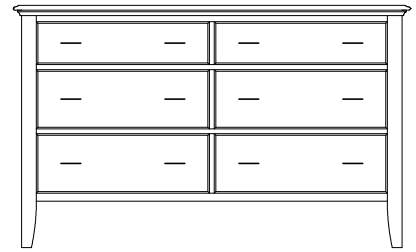

**MO-1454 Dresser** Suggested Mirrors:  
60¼"w 36¾"h 21¾"d  
w/6 drawers

**MI-1430**  
40"h 36"w

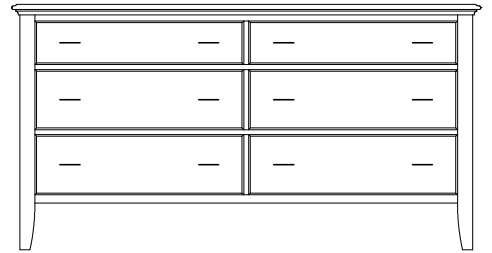

**MO-1455 Dresser** Suggested Mirrors:  
70¼"w 36¾"h 21¾"d  
w/6 drawers

**MI-1431**  
40"h 46"w

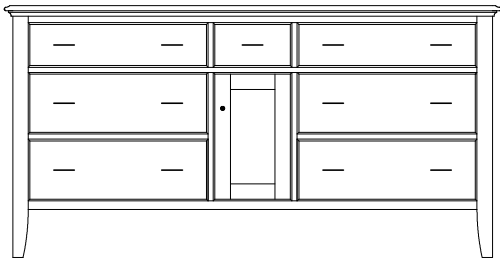

**MO-1456 Dresser**  
72½"w 36¾"h 21¾"d  
w/7 drawers, 1 door,  
1 adjustable shelf

Suggested Mirrors:  
**MI-1431**  
30"h 46"w



**MO-1460 Dresser**  
60¼"w 46"h 21¾"d  
w/8 drawers

Suggested Mirrors:  
**MI-1432**  
32"h 42"w

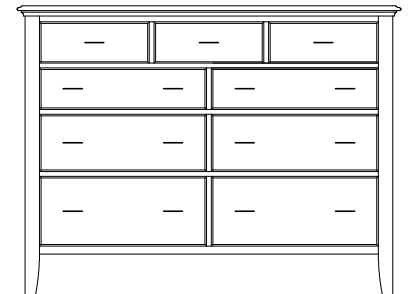

**MO-1457 Dresser**  
60¼"w 46"h 21¾"d  
w/9 drawers

Suggested Mirrors:  
**MI-1432**  
32"h 42"w

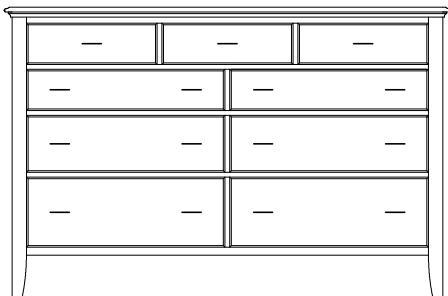

**MO-1458 Dresser**  
70¼"w 46"h 21¾"d  
w/9 drawers

Suggested Mirrors:  
**MI-1433**  
32"h 52"w



**MO-1461 Dresser**  
70¼"w 46"h 21¾"d  
w/8 drawers

Suggested Mirrors:  
**MI-1433**  
32"h 52"w

# Monticello Mirrors

---



**MI-1430 Mirror**  
40"high 36"wide

**MI-1431 Mirror**  
40"high 46"wide

**MI-1432 Mirror**  
32"high 42"wide

**MI-1433 Mirror**  
32"high 52"wide

Beveled Mirror

# Monticello Bed Frames



Monticello Bed  
with Regular Footboard

## Bed Information

### Regular Footboard

**MO-1410-K** (King)  
83 $\frac{3}{8}$ "w 89 $\frac{1}{2}$ "l  
HB 60"h ■ FB 15 $\frac{3}{4}$ "h

**MO-1410-Q** (Queen)  
68"w 89 $\frac{1}{2}$ "l  
HB 60"h ■ FB 15 $\frac{3}{4}$ "h

**MO-1410-F** (Full)  
60 $\frac{7}{8}$ "w 84 $\frac{1}{2}$ "l  
HB 48"h ■ FB 15 $\frac{3}{4}$ "h

**MO-1410-T** (Twin)  
46"w 84 $\frac{1}{2}$ "l  
HB 60"h ■ FB 15 $\frac{3}{4}$ "h

### Headboard Only

**MO-1417-K-HB** (King)  
60" high

**MO-1417-Q-HB** (Queen)  
60" high

**MO-1417-F-HB** (Full)  
60" high

**MO-1417-T-HB** (Twin)  
60" high

# Monticello Storage Rail Upgrades

## 12<sup>3</sup>/<sub>4</sub>" From Floor to Box Spring

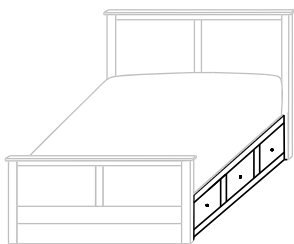

- With 3 drawers on each side
- 12<sup>3</sup>/<sub>4</sub>" from floor to Box Spring
- Inside drawer dimensions on all sizes  
9<sup>1</sup>/<sub>4</sub>"h 18<sup>7</sup>/<sub>8</sub>"w 22<sup>1</sup>/<sub>2</sub>"d

**532-SR-K** King – 6 drawers  
**532-SR-Q** Queen – 6 drawers  
**532-SR-F** Full – 6 drawers  
**532-SR-T** Twin – 3 drawers

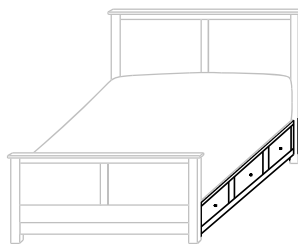

- With 3" Toe Kick
- With 3 drawers on each side
- 12<sup>3</sup>/<sub>4</sub>" from floor to Box Spring
- Inside drawer dimensions on all sizes  
6<sup>1</sup>/<sub>4</sub>"h 18<sup>7</sup>/<sub>8</sub>"w 22<sup>1</sup>/<sub>2</sub>"d

**234-SR-K** King – 6 drawers  
**234-SR-Q** Queen – 6 drawers  
**234-SR-F** Full – 6 drawers  
**234-SR-T** Twin – 3 drawers

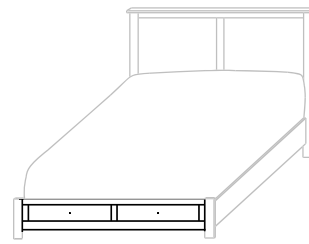

- 12<sup>3</sup>/<sub>4</sub>" from floor to Box Spring
- Inside drawer dimensions  
6<sup>1</sup>/<sub>4</sub>"h 22<sup>1</sup>/<sub>2</sub>"d  
 (King) 31"w      (Queen) 23<sup>1</sup>/<sub>4</sub>"w  
 (Full) 19<sup>5</sup>/<sub>8</sub>"w      (Twin) 29<sup>1</sup>/<sub>4</sub>"w

**685-FDS-K** King – 2 drawers  
**685-FDS-Q** Queen – 2 drawers  
**685-FDS-F** Full – 2 drawers  
**685-FDS-T** Twin – 1 drawer

## 19<sup>3</sup>/<sub>4</sub>" From Floor to Box Spring

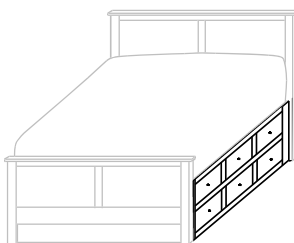

- With 6 drawers on each side
- Twin has 6 drawers on 1 side only
- 19<sup>3</sup>/<sub>4</sub>" from floor to Box Spring
- Inside drawer dimensions on all sizes  
6<sup>1</sup>/<sub>4</sub>"h 18<sup>7</sup>/<sub>8</sub>"w 22<sup>1</sup>/<sub>2</sub>"d

**654-SR-K** King – 12 drawers  
**654-SR-Q** Queen – 12 drawers  
**654-SR-F** Full – 12 drawers  
**654-SR-T** Twin – 6 drawers

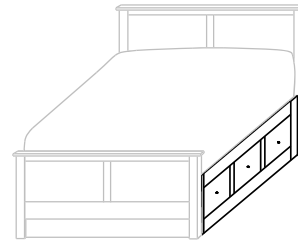

- With 3 drawers on each side
- 19<sup>3</sup>/<sub>4</sub>" from floor to Box Spring
- Inside drawer dimensions on all sizes  
10<sup>1</sup>/<sub>4</sub>"h 18<sup>7</sup>/<sub>8</sub>"w 22<sup>1</sup>/<sub>2</sub>"d

**325-SR-K** King – 6 drawers  
**325-SR-Q** Queen – 6 drawers  
**325-SR-F** Full – 6 drawers  
**325-SR-T** Twin – 3 drawers

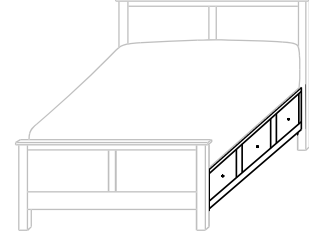

- With 7" Toe Kick
- With 3 drawers on each side
- 19<sup>3</sup>/<sub>4</sub>" from floor to Box Spring
- Inside drawer dimensions on all sizes  
9<sup>1</sup>/<sub>4</sub>"h 18<sup>7</sup>/<sub>8</sub>"w 22<sup>1</sup>/<sub>2</sub>"d

**236-SR-K** King – 6 drawers  
**236-SR-Q** Queen – 6 drawers  
**236-SR-F** Full – 6 drawers  
**236-SR-T** Twin – 3 drawers

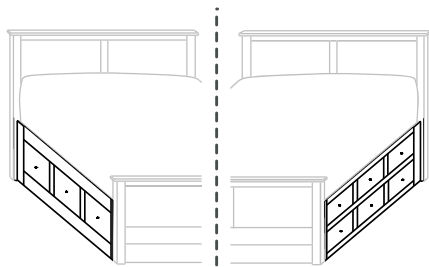

- With 3 drawers on one side and 6 drawers on other side
- 19<sup>3</sup>/<sub>4</sub>" from floor to Box Spring

**420-SR-K** King – 9 drawers  
**420-SR-Q** Queen – 9 drawers  
**420-SR-F** Full – 9 drawers  
 (Twin Not Available)

### Additional Upgrades

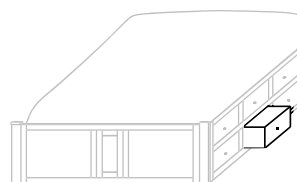

- With Step Stool Pullout in place of drawer

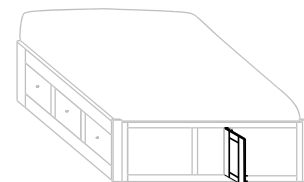

- With Door in Footboard to access area between rails





*Olde Cottage*  
Bedroom Collection

# Olde Cottage



## Olde Cottage Bedroom Collection

- OD-2765Q Queen Bed
- OD-2741 Night Stand
- OD-2750 Chest
- OD-2746 Lingerie
- OD-2754 Dresser
- MI-2730 Mirror

Shown above in **Sap Cherry** with **OCS-113 Micheal's** and **53012-G10 Hardware**

### Standard Features:



53012-G10 Hardware



Standard with side-mount drawer slides

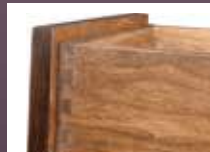

Stained poplar dovetailed drawers



Dovetailed bed slats

### Available Upgrades:

- Any hardware on our Hardware Options Sheet
- Undermount soft close slides [See Price List]



- OD-2765Q Queen Bed
- SH-2742 Night Stand
- SH-2750 Chest
- SH-2754 Dresser
- MI-2730 Mirror

Shown in **Sap Cherry** with **OCS-104 Seely** and **53012-G10 Hardware**

# Olde Cottage Night Stands



**OD-2742**  
Night Stand shown



Sliding top option available on all night stands  
(Hidden compartment w/Lock)

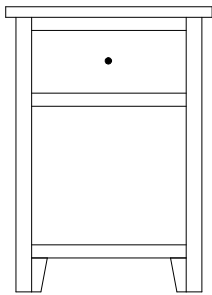

**OD-2740 Night Stand**  
19 $\frac{3}{4}$ "w 27 $\frac{1}{4}$ "h 17 $\frac{1}{2}$ "d  
w/1 drawer

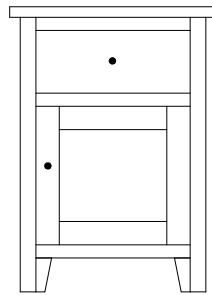

**OD-2741 Night Stand**  
19 $\frac{3}{4}$ "w 27 $\frac{1}{4}$ "h 17 $\frac{1}{2}$ "d  
w/1 drawer & 1 door

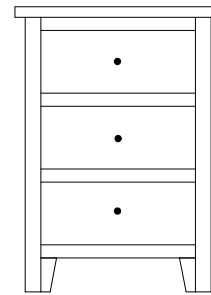

**OD-2742 Night Stand**  
19 $\frac{3}{4}$ "w 27 $\frac{1}{4}$ "h 17 $\frac{1}{2}$ "d  
w/3 drawers

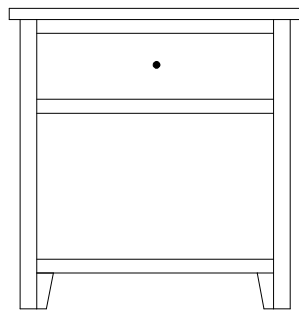

**OD-2743 Night Stand**  
26 $\frac{1}{2}$ "w 27 $\frac{1}{4}$ "h 17 $\frac{1}{2}$ "d  
w/1 drawer

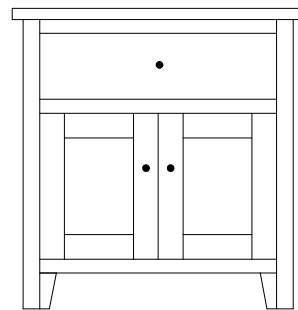

**OD-2744 Night Stand**  
26 $\frac{1}{2}$ "w 27 $\frac{1}{4}$ "h 17 $\frac{1}{2}$ "d  
w/1 drawer, 2 doors

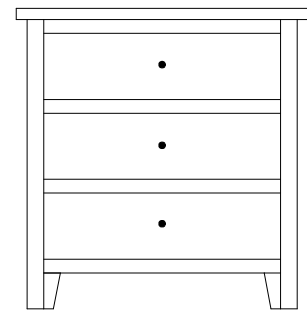

**OD-2745 Night Stand**  
26 $\frac{1}{2}$ "w 27 $\frac{1}{4}$ "h 17 $\frac{1}{2}$ "d  
w/3 drawers

# Olde Cottage Lingeries & Chests



**OD-2750**  
Chest shown

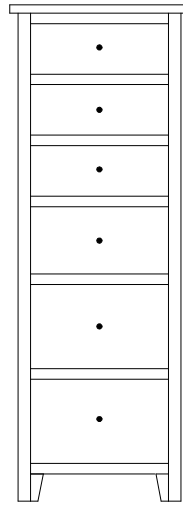

**OD-2746 Lingerie**  
21 $\frac{3}{8}$ "w 59"h 21 $\frac{1}{2}$ "d  
w/6 drawers

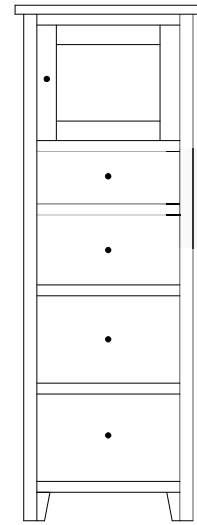

Available with  
mirror in  
door panel

**OD-2747 Lingerie**  
21 $\frac{3}{8}$ "w 59"h 21 $\frac{1}{2}$ "d  
w/4 drawers, 1 wood door,  
1 adjustable shelf

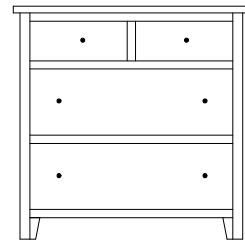

**OD-2749 Chest**  
35 $\frac{3}{4}$ "w 35 $\frac{1}{4}$ "h 21 $\frac{1}{2}$ "d  
w/4 drawers

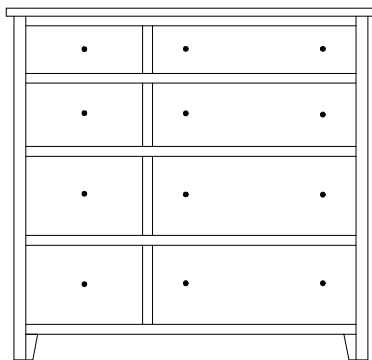

**OD-2748 Chest**  
46 $\frac{3}{4}$ "w 44 $\frac{1}{2}$ "h 21 $\frac{1}{2}$ "d  
w/8 drawers

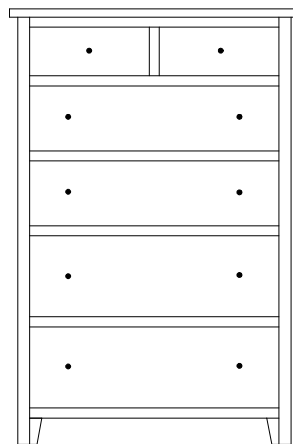

**OD-2750 Chest**  
35 $\frac{3}{4}$ "w 53 $\frac{3}{4}$ "h 21 $\frac{1}{2}$ "d  
w/6 drawers

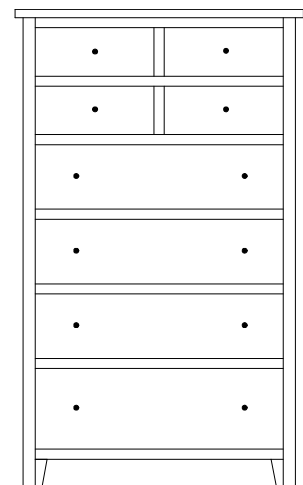

**OD-2751 Hi-Boy**  
35 $\frac{3}{4}$ "w 59"h 21 $\frac{1}{2}$ "d  
w/8 drawers

# Olde Cottage Miscellaneous

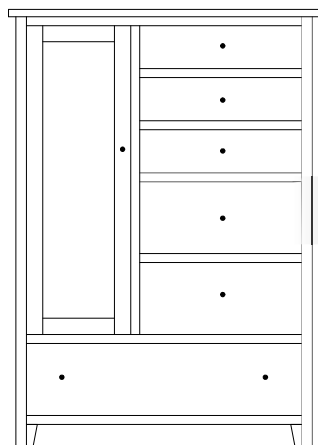

Option:  
Mirror on  
back of door

**OD-2752 Chifferobe**  
43¼"w 61"h 21½"d  
w/6 drawers, 1 door, 2 adj. shelves

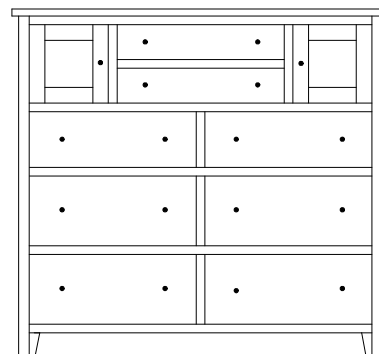

**OD-2753 His & Hers Chest**  
54¼"w 49¾"h 21½"d  
w/8 drawers, 2 doors

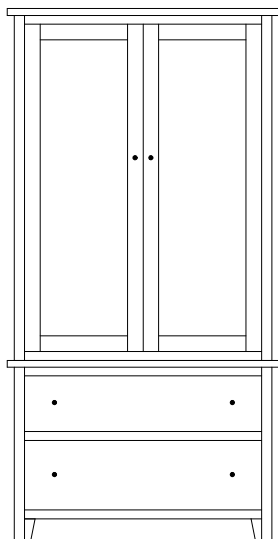

**OD-2762 Armoire**  
39"w 76¼"h 21½"d  
w/2 drawers, w/2 doors,  
2 adj. shelves & closet rod

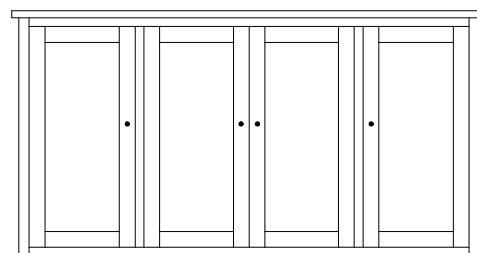

**OD-2759 Mule Chest Top**  
67¾"w 35"h 21½"d  
w/4 doors & 6 adjustable shelves

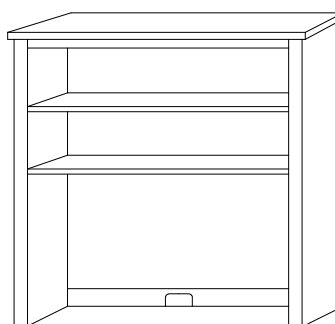

**OD-2797 Study Carrel**  
48"w 42"h 13"d  
w/2 adjustable shelves

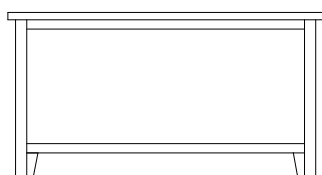

**OD-2735 Blanket Chest**  
42"w 22"h 21½"d

Available  
with aromatic  
cedar bottom

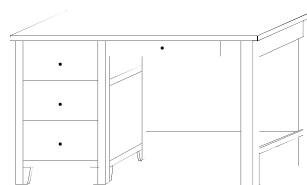

**OD-2799 Student Desk**  
48"w 28¾"h 23"d  
w/3 drawers  
w/1 pencil drawer

Upgrades available on student desk:

Keyboard slideout instead of pencil drawer  
File drawer instead of bottom 2 drawers

# Olde Cottage Dressers



**OD-2754** Dresser shown with **MI-2730** Mirror

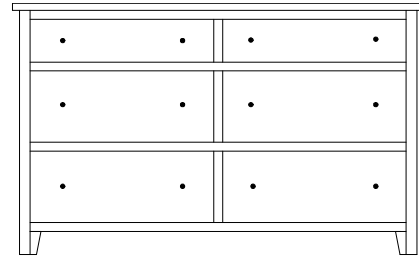

**OD-2754 Dresser**  
57¾"w 35¼"h 21½"d  
w/6 drawers

Suggested Mirrors:

**MI-2730 Mirror**  
40"h 36"w

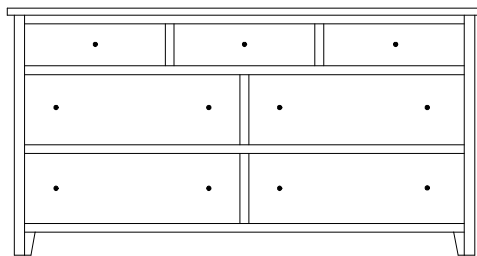

**OD-2755 Dresser**  
67¾"w 35¼"h 21½"d  
w/7 drawers

Suggested Mirrors:

**MI-2731 Mirror**  
40"h 46"w

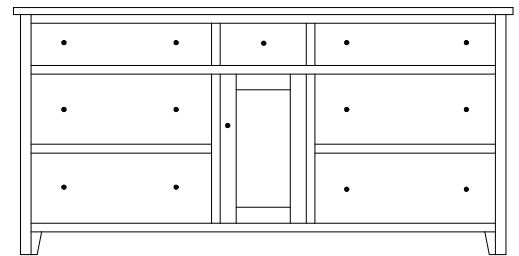

**OD-2756 Dresser**  
71¼"w 35¼"h 21½"d  
w/7 drawers, 1 door  
w/1 adjustable shelf

Suggested Mirrors:

**MI-2731 Mirror**  
40"h 46"w

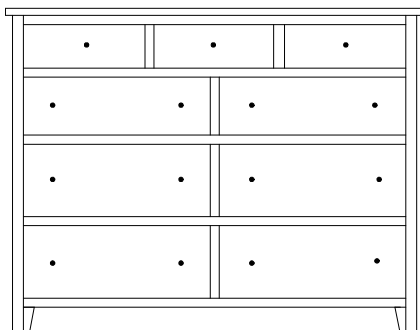

**OD-2757 59" Dresser**  
57¾"w 44½"h 21½"d  
w/9 drawers

Suggested Mirrors:

**MI-2732 Mirror**  
32"h 42"w

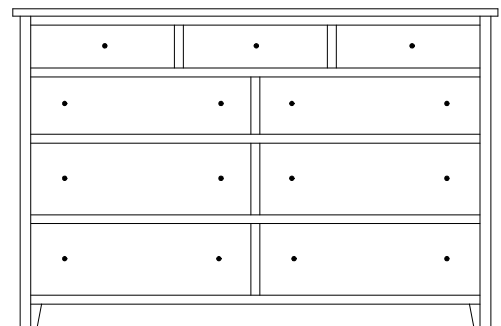

**OD-2758 Tall Dresser**  
67¾"w 44½"h 21½"d  
w/9 drawers

Suggested Mirrors:

**MI-2733 Mirror**  
32"h 52"w

# Olde Cottage Mirrors

---



**MI-2730 Mirror**  
40"h 36"w

**MI-2731 Mirror**  
40"h 46"w

**MI-2732 Mirror**  
32"h 42"w

**MI-2733 Mirror**  
32"h 52"w

Beveled Mirror

# Olde Cottage Bed Frames



shown with **Regular Footboard**

## Olde Cottage Bed

### Regular Footboard

Available  
with underbed  
storage options.

**OD-2765-K** (King)  
81 $\frac{3}{8}$ "w 87 $\frac{1}{2}$ "l  
HB 56"h ■ FB 17"h

**OD-2765-Q** (Queen)  
66"w 87 $\frac{1}{2}$ "l  
HB 56"h ■ FB 17"h

**OD-2765-F** (Full)  
58 $\frac{7}{8}$ "w 87 $\frac{1}{2}$ "l  
HB 56"h ■ FB 17"h

**OD-2765-T** (Twin)  
44"w 87 $\frac{1}{2}$ "l  
HB 56"h ■ FB 17"h

### Low Footboard

**OD-2766-K** (King)  
81 $\frac{3}{8}$ "w 86"l  
HB 56"h ■ FB 14 $\frac{3}{4}$ "h

**OD-2766-Q** (Queen)  
66"w 86"l  
HB 56"h ■ FB 14 $\frac{3}{4}$ "h

**OD-2766-F** (Full)  
58 $\frac{7}{8}$ "w 81"l  
HB 56"h ■ FB 14 $\frac{3}{4}$ "h

**OD-2766-T** (Twin)  
44"w 81"l  
HB 56"h ■ FB 14 $\frac{3}{4}$ "h

### Headboard Only

**OD-2767K-HB** (King)  
56" high

**OD-2767Q-HB** (Queen)  
56" high

**OD-2767F-HB** (Full)  
56" high

**OD-2767T-HB** (Twin)  
56" high

# Olde Cottage Storage Rail Upgrades

## 12<sup>3</sup>/<sub>4</sub>" From Floor to Box Spring

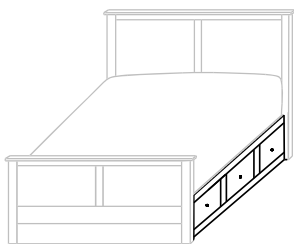

- With 3 drawers on each side
- 12<sup>3</sup>/<sub>4</sub>" from floor to Box Spring
- Inside drawer dimensions on all sizes  
9<sup>1</sup>/<sub>4</sub>"h 18<sup>7</sup>/<sub>8</sub>"w 22<sup>1</sup>/<sub>2</sub>"d

**532-SR-K** King – 6 drawers  
**532-SR-Q** Queen – 6 drawers  
**532-SR-F** Full – 6 drawers  
**532-SR-T** Twin – 3 drawers

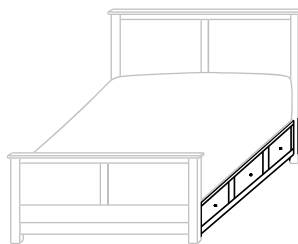

- With 3" Toe Kick
- With 3 drawers on each side
- 12<sup>3</sup>/<sub>4</sub>" from floor to Box Spring
- Inside drawer dimensions on all sizes  
6<sup>1</sup>/<sub>4</sub>"h 18<sup>7</sup>/<sub>8</sub>"w 22<sup>1</sup>/<sub>2</sub>"d

**234-SR-K** King – 6 drawers  
**234-SR-Q** Queen – 6 drawers  
**234-SR-F** Full – 6 drawers  
**234-SR-T** Twin – 3 drawers

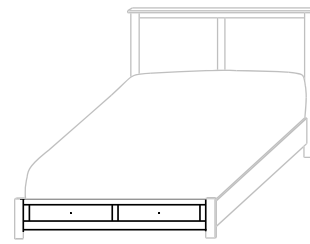

- 12<sup>3</sup>/<sub>4</sub>" from floor to Box Spring
- Inside drawer dimensions  
6<sup>1</sup>/<sub>4</sub>"h 22<sup>1</sup>/<sub>2</sub>"d  
 (King) 31"w      (Queen) 23<sup>1</sup>/<sub>4</sub>"w  
 (Full) 19<sup>5</sup>/<sub>8</sub>"w      (Twin) 29<sup>1</sup>/<sub>4</sub>"w

**685-FDS-K** King – 2 drawers  
**685-FDS-Q** Queen – 2 drawers  
**685-FDS-F** Full – 2 drawers  
**685-FDS-T** Twin – 1 drawer

## 19<sup>3</sup>/<sub>4</sub>" From Floor to Box Spring

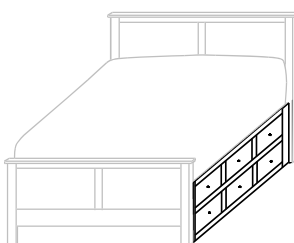

- With 6 drawers on each side
- Twin has 6 drawers on 1 side only
- 19<sup>3</sup>/<sub>4</sub>" from floor to Box Spring
- Inside drawer dimensions on all sizes  
6<sup>1</sup>/<sub>4</sub>"h 18<sup>7</sup>/<sub>8</sub>"w 22<sup>1</sup>/<sub>2</sub>"d

**654-SR-K** King – 12 drawers  
**654-SR-Q** Queen – 12 drawers  
**654-SR-F** Full – 12 drawers  
**654-SR-T** Twin – 6 drawers

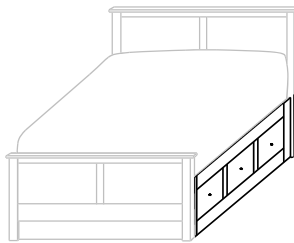

- With 3 drawers on each side
- 19<sup>3</sup>/<sub>4</sub>" from floor to Box Spring
- Inside drawer dimensions on all sizes  
10<sup>1</sup>/<sub>4</sub>"h 18<sup>7</sup>/<sub>8</sub>"w 22<sup>1</sup>/<sub>2</sub>"d

**325-SR-K** King – 6 drawers  
**325-SR-Q** Queen – 6 drawers  
**325-SR-F** Full – 6 drawers  
**325-SR-T** Twin – 3 drawers

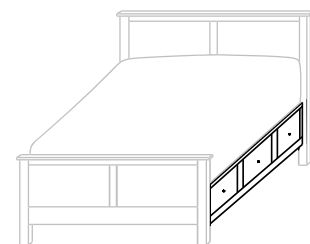

- With 7" Toe Kick
- With 3 drawers on each side
- 19<sup>3</sup>/<sub>4</sub>" from floor to Box Spring
- Inside drawer dimensions on all sizes  
9<sup>1</sup>/<sub>4</sub>"h 18<sup>7</sup>/<sub>8</sub>"w 22<sup>1</sup>/<sub>2</sub>"d

**236-SR-K** King – 6 drawers  
**236-SR-Q** Queen – 6 drawers  
**236-SR-F** Full – 6 drawers  
**236-SR-T** Twin – 3 drawers

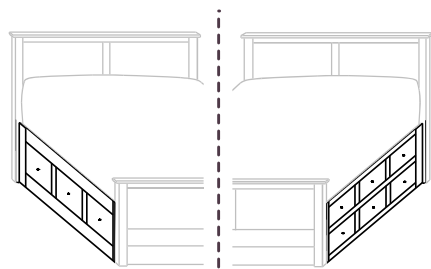

- With 3 drawers on one side and 6 drawers on other side
- 19<sup>3</sup>/<sub>4</sub>" from floor to Box Spring

**420-SR-K** King – 9 drawers  
**420-SR-Q** Queen – 9 drawers  
**420-SR-F** Full – 9 drawers  
 (Twin Not Available)

### Additional Upgrades

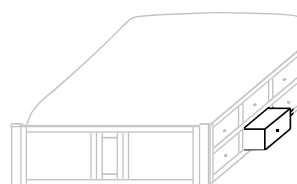

- With Step Stool Pullout in place of drawer

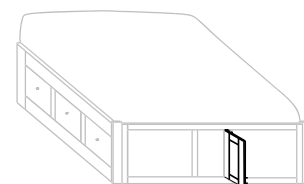

- With Door in Footboard to access area between rails





*Regency*  
Bedroom Collection

# Regency



## Regency Bedroom Collection

- RG-2665Q Queen Bed w/ 532 Storage Upgrade
- RG-2642 Night Stand
- RG-2657 Dresser
- RG-2650 Chest
- RG-2635 Blanket Chest w/ Optional Leather Seat
- MI-2632 Mirror

Shown above in **Sap Cherry** with **New Carrington** with **4425-G10 Knobs** and **4424-G10 Pulls**

### Standard Features:



4425-G10 Knobs & 4424-G10 Pulls



Standard with side-mount drawer slides



Stained poplar dovetailed drawers



Dovetailed bed slats

### Available Upgrades:

- Any hardware on our Hardware Options Sheet
- Undermount soft close slides [See Price List]



- RG-2665Q Queen Bed
- RG-2642 Night Stand
- RG-2650 Chest
- RG-2657 Dresser
- MI-2632 Mirror

Shown in **Brown Maple** with **OCS-117 Asbury** and **4425-G10 Knob** and **4424-G10 Pulls**

# Regency Night Stands



Sliding top option available on all night stands  
(Hidden compartment w/Lock)

**RG-2642**  
Night Stand shown

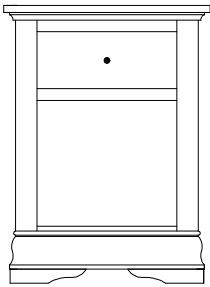

**RG-2640 Night Stand**  
21 $\frac{3}{4}$ "w 29 $\frac{1}{4}$ "h 17 $\frac{3}{4}$ "d  
w/1 drawer

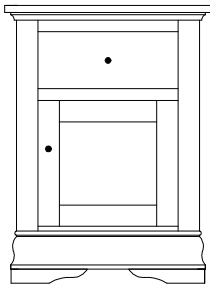

**RG-2641 Night Stand**  
21 $\frac{3}{4}$ "w 29 $\frac{1}{4}$ "h 17 $\frac{3}{4}$ "d  
w/1 drawer, 1 door

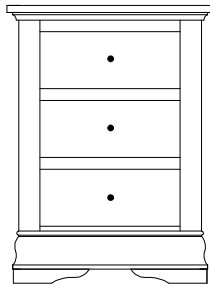

**RG-2642 Night Stand**  
21 $\frac{3}{4}$ "w 29 $\frac{1}{4}$ "h 17 $\frac{3}{4}$ "d  
w/3 drawers

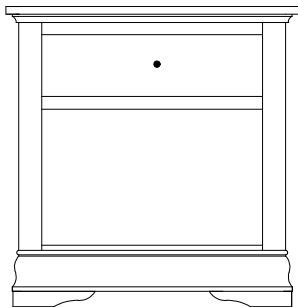

**RG-2643 Night Stand**  
28 $\frac{1}{2}$ "w 29 $\frac{1}{4}$ "h 17 $\frac{3}{4}$ "d  
w/1 drawer

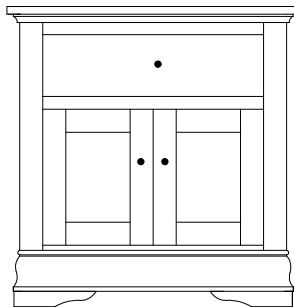

**RG-2644 Night Stand**  
28 $\frac{1}{2}$ "w 29 $\frac{1}{4}$ "h 17 $\frac{3}{4}$ "d  
w/1 drawer, 2 doors

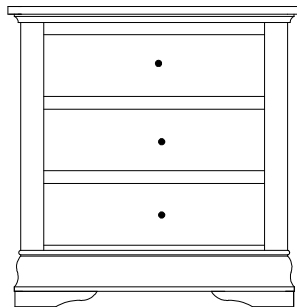

**RG-2645 Night Stand**  
28 $\frac{1}{2}$ "w 29 $\frac{1}{4}$ "h 17 $\frac{3}{4}$ "d  
w/3 drawers

# Regency Lingeries & Chests



**RG-2650**  
Chest shown

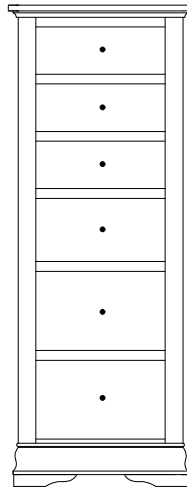

**RG-2646 Lingerie**  
23 $\frac{3}{8}$ "w 61"h 21 $\frac{3}{4}$ "d  
w/6 drawers

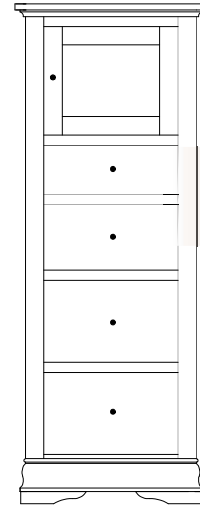

Available with  
mirror in  
door panel

**RG-2647 Lingerie**  
23 $\frac{3}{8}$ "w 61"h 21 $\frac{3}{4}$ "d  
w/4 drawers, 1 wood door,  
1 adjustable shelf

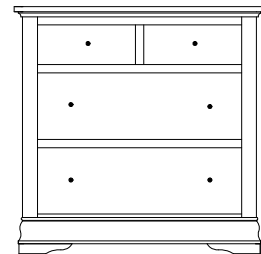

**RG-2649 Chest**  
37 $\frac{3}{4}$ "w 37 $\frac{1}{4}$ "h 21 $\frac{3}{4}$ "d  
w/4 drawers

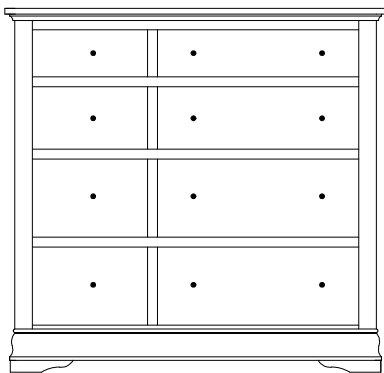

**RG-2648 Chest**  
48 $\frac{3}{4}$ "w 46 $\frac{1}{2}$ "h 21 $\frac{3}{4}$ "d  
w/8 drawers

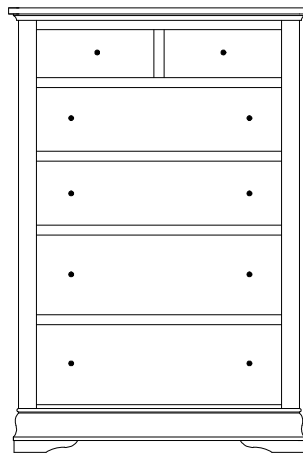

**RG-2650 Chest**  
37 $\frac{3}{4}$ "w 55 $\frac{3}{4}$ "h 21 $\frac{3}{4}$ "d  
w/6 drawers

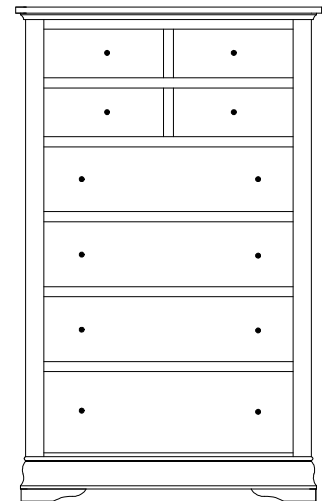

**RG-2651 Hi-Boy**  
37 $\frac{3}{4}$ "w 61"h 21 $\frac{3}{4}$ "d  
w/8 drawers

# Regency Miscellaneous

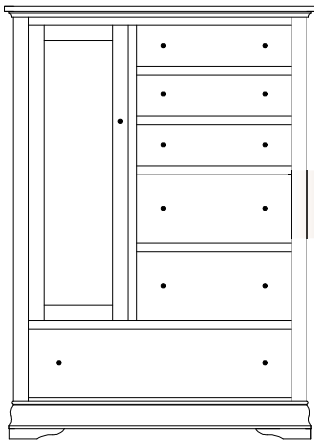

Option:  
Mirror on  
back of door

**RG-2652 Chifferobe**  
45¼"w 63"h 21¾"d  
w/6 drawers, 1 door, 2 adj. shelves

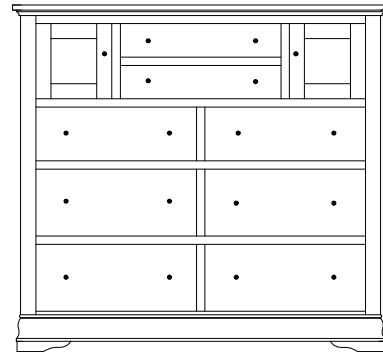

**RG-2653 His & Hers Chest**  
56¼"w 51¾"h 21¾"d  
w/8 drawers, 2 doors

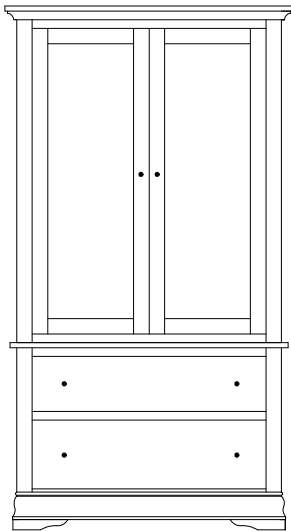

**RG-2662 Armoire**  
42"w 76¼"h 22¼"d  
w/2 drawers, w/2 doors,  
2 adj. shelves & closet rod

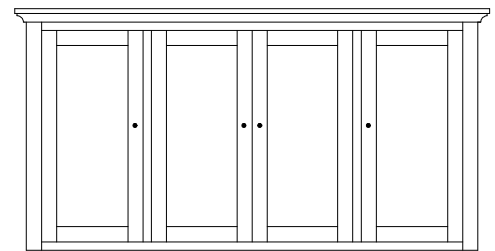

**RG-2659 Mule Chest Top**  
70¾"w 36"h 22¼"d  
w/4 doors & 6 adjustable shelves

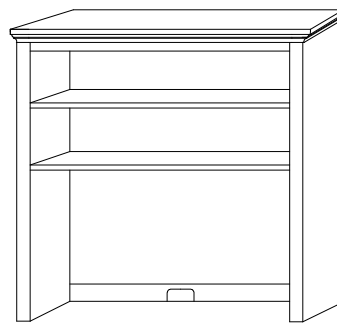

**RG-2697 Study Carrel**  
49"w 42"h 13¾"d  
w/2 adjustable shelves

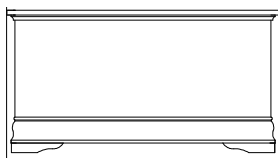

**RG-2635 Blanket Chest**  
42"w 22"h 21½"d

- Available  
with aromatic  
cedar bottom  
- Fabric or  
Leather Seat

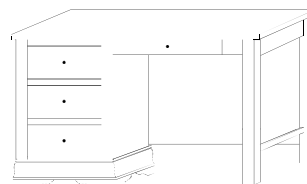

**RG-2699 Student Desk**  
48"w 30"h 23"d  
w/3 drawers  
w/1 pencil drawer

Upgrades available on student desk:

Keyboard slideout instead of pencil drawer  
File drawer instead of bottom 2 drawers

# Regency Dressers



RG-2657 Dresser shown with MI-2632 Mirror

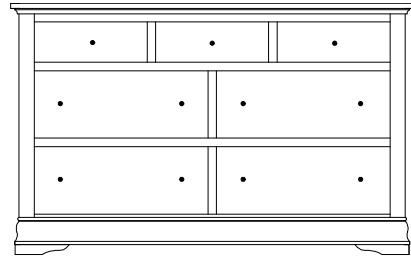

**RG-2654 Dresser**  
59¾"w 37¼"h 21¾"d  
w/7 drawers

Suggested Mirrors:

**MI-2630 Mirror**  
40"h 36"w

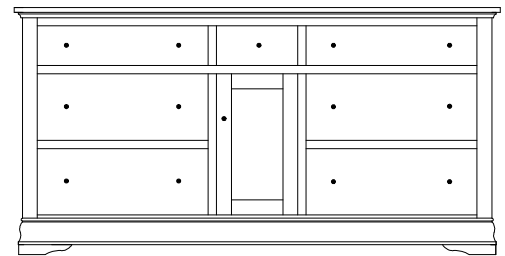

**RG-2656 Dresser**  
73¼"w 37¼"h 21¾"d  
w/7 drawers, 1 door  
w/1 adjustable shelf

Suggested Mirrors:

**MI-2631 Mirror**  
40"h 46"w

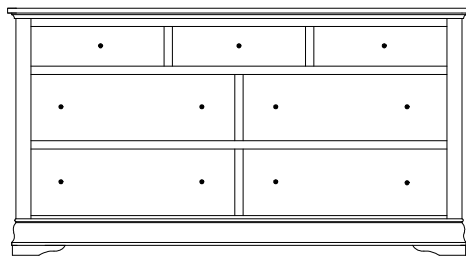

**RG-2655 Dresser**  
69¾"w 37¼"h 21¾"d  
w/7 drawers

Suggested Mirrors:

**MI-2631 Mirror**  
40"h 46"w

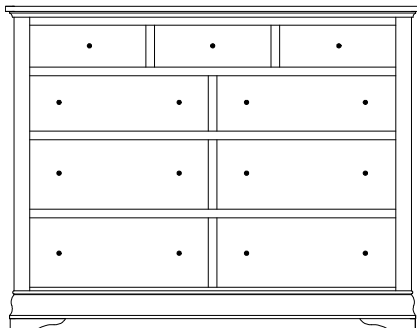

**RG-2657 Dresser**  
59¾"w 46½"h 21¾"d  
w/9 drawers

Suggested Mirrors:

**MI-2632 Mirror**  
32"h 42"w

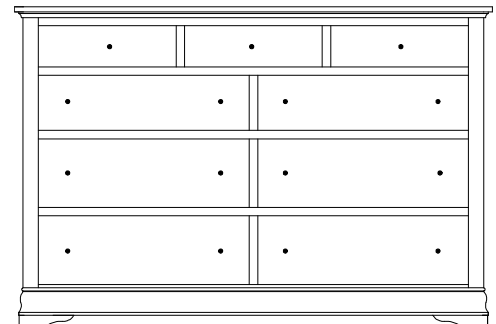

**RG-2658 Dresser**  
69¾"w 46½"h 21¾"d  
w/9 drawers

Suggested Mirrors:

**MI-2633 Mirror**  
32"h 52"w

# Regency Mirrors

---



**MI-2630 Mirror**  
40"h 36"w

**MI-2631 Mirror**  
40"h 46"w

**MI-2632 Mirror**  
32"h 42"w

**MI-2633 Mirror**  
32"h 52"w

Beveled Mirror

# Regency Bed Frames



Bed shown with 532 Storage Upgrade and Regular Footboard

## Regency Bed Regular Footboard

Available  
with underbed  
storage options.

**RG-2665-K** (King)  
79½"w 96½"l  
HB 58"h ■ FB 38½"h

**RG-2665-Q** (Queen)  
64½"w 96½"l  
HB 58"h ■ FB 38½"h

**RG-2665-F** (Full)  
57"w 91½"l  
HB 58"h ■ FB 38½"h

**RG-2665-T** (Twin)  
42½"w 91½"l  
HB 58"h ■ FB 38½"h

## Low Footboard

**RG-2666-K** (King)  
79½"w 90¾"l  
HB 58"h ■ FB 14¾"h

**RG-2666-Q** (Queen)  
64½"w 90¾"l  
HB 58"h ■ FB 14¾"h

**RG-2666-F** (Full)  
57"w 85¾"l  
HB 58"h ■ FB 14¾"h

**RG-2666-T** (Twin)  
42½"w 85¾"l  
HB 58"h ■ FB 14¾"h

## Headboard Only

**RG-2667K-HB** (King)  
58" high

**RG-2667Q-HB** (Queen)  
58" high

**RG-2667F-HB** (Full)  
58" high

**RG-2667T-HB** (Twin)  
58" high

# Regency Storage Rail Upgrades

## 12<sup>3</sup>/<sub>4</sub>" From Floor to Box Spring

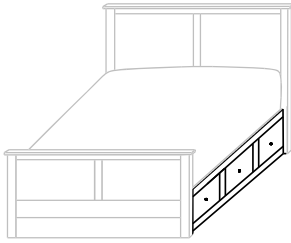

- With 3 drawers on each side
- 12<sup>3</sup>/<sub>4</sub>" from floor to Box Spring
- Inside drawer dimensions on all sizes  
9<sup>1</sup>/<sub>4</sub>"h 18<sup>7</sup>/<sub>8</sub>"w 22<sup>1</sup>/<sub>2</sub>"d

**532-SR-K** King – 6 drawers  
**532-SR-Q** Queen – 6 drawers  
**532-SR-F** Full – 6 drawers  
**532-SR-T** Twin – 3 drawers

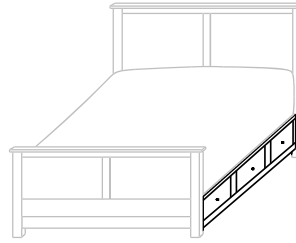

- With 3" Toe Kick
- With 3 drawers on each side
- 12<sup>3</sup>/<sub>4</sub>" from floor to Box Spring
- Inside drawer dimensions on all sizes  
6<sup>1</sup>/<sub>4</sub>"h 18<sup>7</sup>/<sub>8</sub>"w 22<sup>1</sup>/<sub>2</sub>"d

**234-SR-K** King – 6 drawers  
**234-SR-Q** Queen – 6 drawers  
**234-SR-F** Full – 6 drawers  
**234-SR-T** Twin – 3 drawers

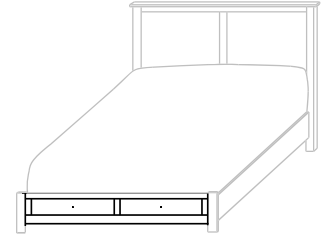

- 12<sup>3</sup>/<sub>4</sub>" from floor to Box Spring
- Inside drawer dimensions  
6<sup>1</sup>/<sub>4</sub>"h 22<sup>1</sup>/<sub>2</sub>"d  
 (King) 31"w      (Queen) 23<sup>1</sup>/<sub>4</sub>"w  
 (Full) 19<sup>5</sup>/<sub>8</sub>"w      (Twin) 29<sup>1</sup>/<sub>4</sub>"w

**685-FDS-K** King – 2 drawers  
**685-FDS-Q** Queen – 2 drawers  
**685-FDS-F** Full – 2 drawers  
**685-FDS-T** Twin – 1 drawer

## 19<sup>3</sup>/<sub>4</sub>" From Floor to Box Spring

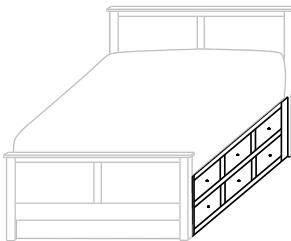

- With 6 drawers on each side
- Twin has 6 drawers on 1 side only
- 19<sup>3</sup>/<sub>4</sub>" from floor to Box Spring
- Inside drawer dimensions on all sizes  
6<sup>1</sup>/<sub>4</sub>"h 18<sup>7</sup>/<sub>8</sub>"w 22<sup>1</sup>/<sub>2</sub>"d

**654-SR-K** King – 12 drawers  
**654-SR-Q** Queen – 12 drawers  
**654-SR-F** Full – 12 drawers  
**654-SR-T** Twin – 6 drawers

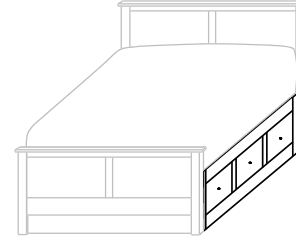

- With 3 drawers on each side
- 19<sup>3</sup>/<sub>4</sub>" from floor to Box Spring
- Inside drawer dimensions on all sizes  
10<sup>1</sup>/<sub>4</sub>"h 18<sup>7</sup>/<sub>8</sub>"w 22<sup>1</sup>/<sub>2</sub>"d

**325-SR-K** King – 6 drawers  
**325-SR-Q** Queen – 6 drawers  
**325-SR-F** Full – 6 drawers  
**325-SR-T** Twin – 3 drawers

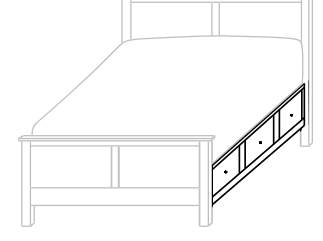

- With 7" Toe Kick
- With 3 drawers on each side
- 19<sup>3</sup>/<sub>4</sub>" from floor to Box Spring
- Inside drawer dimensions on all sizes  
9<sup>1</sup>/<sub>4</sub>"h 18<sup>7</sup>/<sub>8</sub>"w 22<sup>1</sup>/<sub>2</sub>"d

**236-SR-K** King – 6 drawers  
**236-SR-Q** Queen – 6 drawers  
**236-SR-F** Full – 6 drawers  
**236-SR-T** Twin – 3 drawers

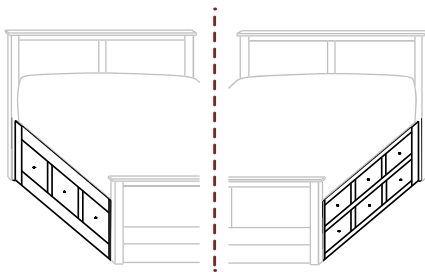

- With 3 drawers on one side and 6 drawers on other side
- 19<sup>3</sup>/<sub>4</sub>" from floor to Box Spring

**420-SR-K** King – 9 drawers  
**420-SR-Q** Queen – 9 drawers  
**420-SR-F** Full – 9 drawers  
 (Twin Not Available)

### Additional Upgrades

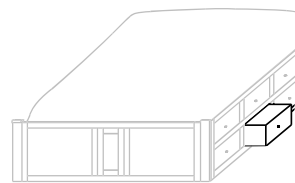

- With Step Stool Pullout in place of drawer

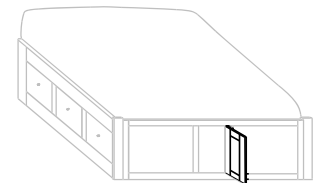

- With Door in Footboard to access area between rails





*Rosedale*  
Bedroom Collection

# Rosedale



## Rosedale Bedroom Collection

- RD-3165Q Queen Bed w/234 Storage Upgrade
- RD-3142 Night Stand
- RD-3150 Chest
- RD-3157 Dresser
- MI-3132 Mirror

Shown above in **Sap Cherry** with **OCS-117 Asbury** with **4424-G10 Pulls**

### Standard Features:



4424-G10 Pulls



Standard with side-mount drawer slides



Stained poplar dovetailed drawers



Dovetailed bed slats

### Available Upgrades:

- Any hardware on our Hardware Options Sheet
- Undermount soft close slides [See Price List]



- RD-3165Q Queen Bed
- RD-3142 Night Stand
- RD-3150 Chest
- RD-3157 Dresser
- MI-3132 Mirror

Shown in **Sap Cherry** with **FC-42000 Almond** and **4424-ORB Pulls**

# Rosedale Night Stands



**RD-3142**  
Night Stand shown



Sliding top option available on all night stands  
(Hidden compartment w/Lock)

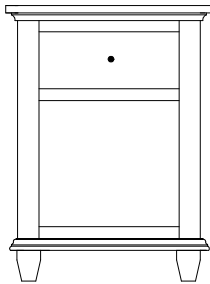

**RD-3140 Night Stand**  
21 $\frac{3}{4}$ "w 29"h 17 $\frac{3}{4}$ "d  
w/1 drawer

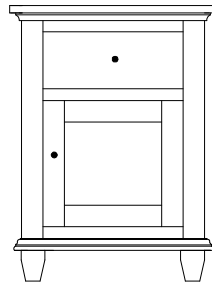

**RD-3141 Night Stand**  
21 $\frac{3}{4}$ "w 29"h 17 $\frac{3}{4}$ "d  
w/1 drawer & 1 door

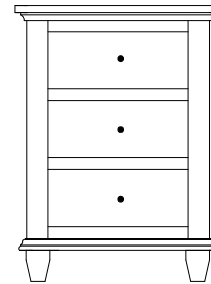

**RD-3142 Night Stand**  
21 $\frac{3}{4}$ "w 29"h 17 $\frac{3}{4}$ "d  
w/3 drawers

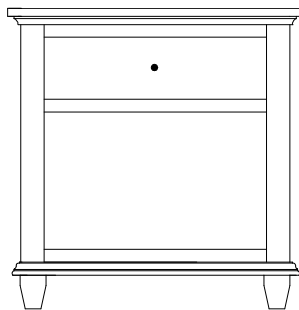

**RD-3143 Night Stand**  
28 $\frac{1}{2}$ "w 29"h 17 $\frac{3}{4}$ "d  
w/1 drawer

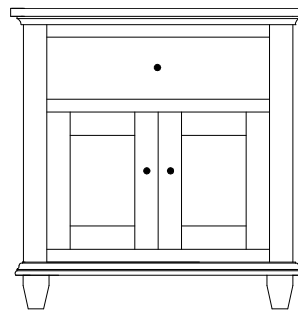

**RD-3144 Night Stand**  
28 $\frac{1}{2}$ "w 29"h 17 $\frac{3}{4}$ "d  
w/1 drawer, 2 doors

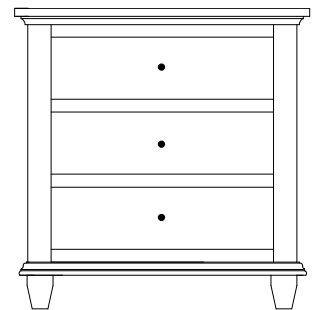

**RD-3145 Night Stand**  
28 $\frac{1}{2}$ "w 29"h 17 $\frac{3}{4}$ "d  
w/3 drawers

# Rosedale Lingeries & Chests



**RD-3150**  
Chest shown

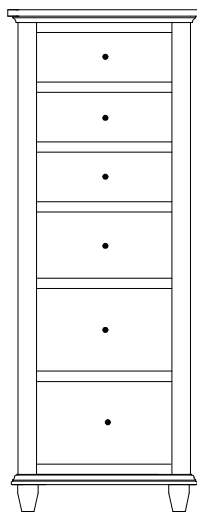

**RD-3146 Lingerie**  
23 $\frac{3}{8}$ "w 60 $\frac{3}{4}$ "h 21 $\frac{3}{4}$ "d  
w/6 drawers

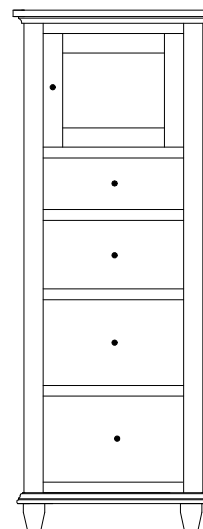

**RD-3147 Lingerie**  
23 $\frac{3}{8}$ "w 60 $\frac{3}{4}$ "h 21 $\frac{3}{4}$ "d  
w/4 drawers, 1 wood door,  
1 adjustable shelf



**RD-3149 Chest**  
37 $\frac{3}{4}$ "w 37"h 21 $\frac{3}{4}$ "d  
w/4 drawers

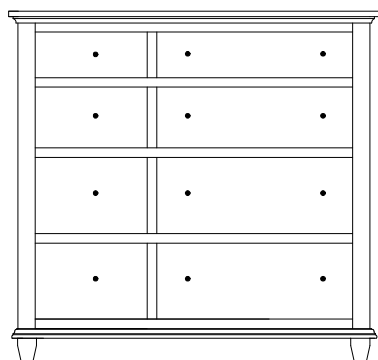

**RD-3148 Chest**  
48 $\frac{3}{4}$ "w 46 $\frac{1}{4}$ "h 21 $\frac{3}{4}$ "d  
w/8 drawers

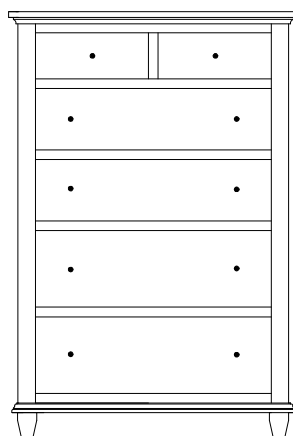

**RD-3150 Chest**  
37 $\frac{3}{4}$ "w 55 $\frac{1}{2}$ "h 21 $\frac{3}{4}$ "d  
w/6 drawers

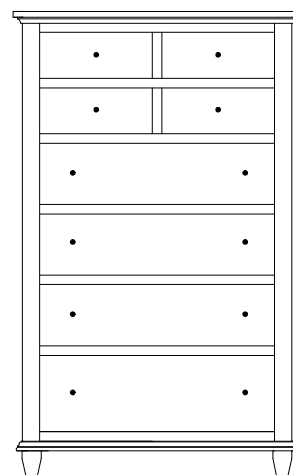

**RD-3151 Hi-Boy**  
37 $\frac{3}{4}$ "w 60 $\frac{3}{4}$ "h 21 $\frac{3}{4}$ "d  
w/8 drawers

# Rosedale Miscellaneous

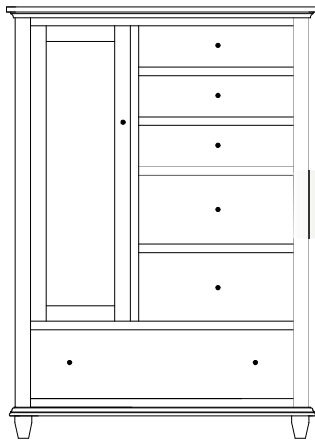

Option:  
Mirror on  
back of door

**RD-3152 Chifferobe**  
45¼"w 62¾"h 21¾"d  
w/6 drawers, 1 door, 2 adj. shelves

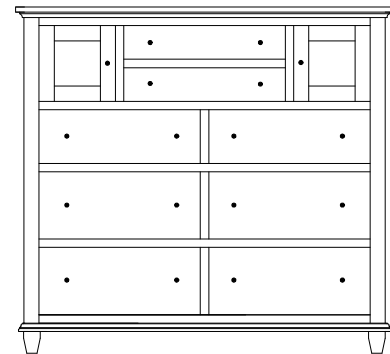

**RD-3153 His & Hers Chest**  
56¼"w 51½"h 21¾"d  
w/8 drawers, 2 doors

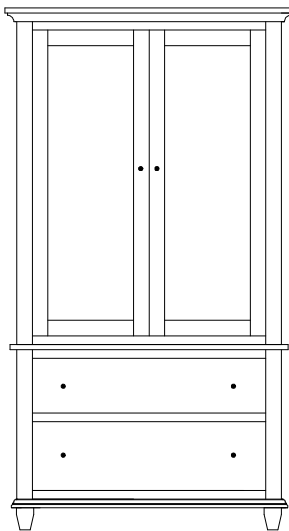

**RD-3162 Armoire**  
42"w 76¼"h 22¼"d  
w/2 drawers, w/2 doors,  
2 adj. shelves & closet rod

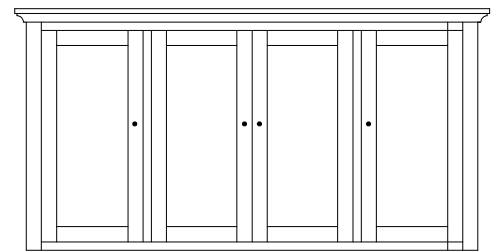

**RD-3159 Mule Chest Top**  
70¾"w 36"h 22¼"d  
w/4 doors & 6 adjustable shelves

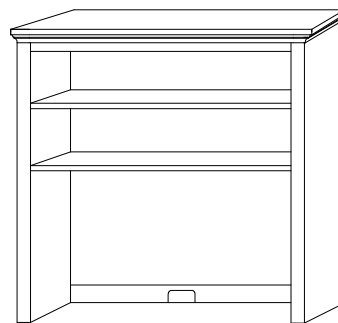

**RD-3197 Study Carrel**  
49½"w 42"h 13¾"d  
w/2 adjustable shelves

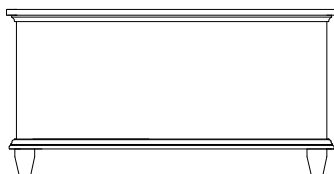

**RD-3135 Blanket Chest**  
42"w 22"h 21½"d

Available  
with aromatic  
cedar bottom

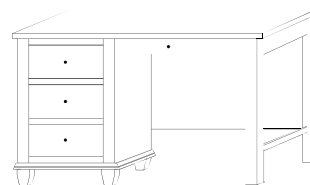

**RD-3199 Student Desk**  
48"w 29¾"h 23"d  
w/3 drawers  
w/1 pencil drawer

Upgrades available on student desk:

Keyboard slideout instead of pencil drawer  
File drawer instead of bottom 2 drawers

# Rosedale Dressers



RD-3157 Dresser shown with MI-2370 Mirror

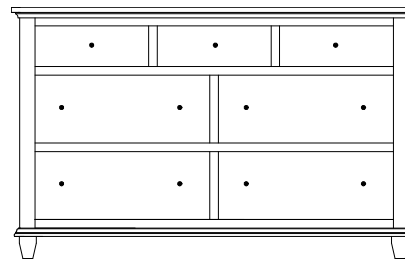

**RD-3154 Dresser**  
58 $\frac{3}{4}$ "w 35 $\frac{3}{4}$ "h 21 $\frac{1}{2}$ "d  
w/7 drawers

Suggested Mirrors:

**MI-3130 Mirror**  
40"h 36"w

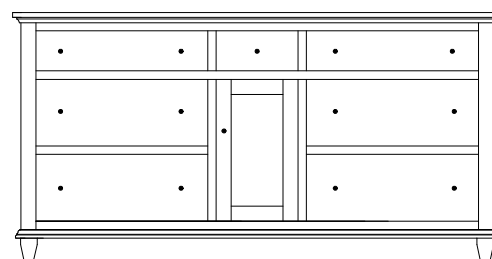

**RD-3156 Dresser**  
72 $\frac{1}{4}$ "w 35 $\frac{3}{4}$ "h 21 $\frac{1}{2}$ "d  
w/7 drawers, 1 door  
w/1 adjustable shelf

Suggested Mirrors:

**MI-3131 Mirror**  
40"h 46"w

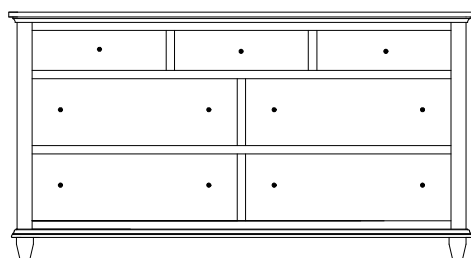

**RD-3155 Dresser**  
68 $\frac{3}{4}$ "w 35 $\frac{3}{4}$ "h 21 $\frac{1}{2}$ "d  
w/7 drawers

Suggested Mirrors:

**MI-3131 Mirror**  
40"h 46"w

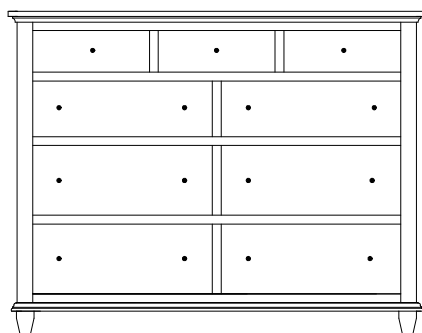

**RD-3157 Dresser**  
58 $\frac{3}{4}$ "w 45"h 21 $\frac{1}{2}$ "d  
w/9 drawers

Suggested Mirrors:

**MI-3132 Mirror**  
32"h 42"w

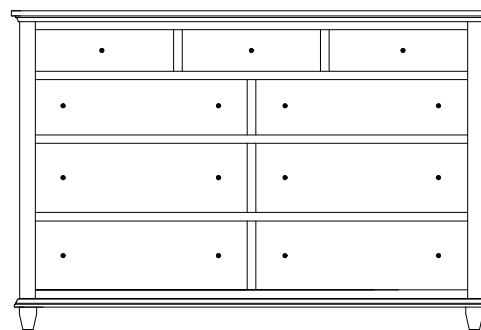

**RD-3158 Dresser**  
68 $\frac{3}{4}$ "w 45"h 21 $\frac{1}{2}$ "d  
w/9 drawers

Suggested Mirrors:

**MI-3133 Mirror**  
32"h 52"w



**MI-3130 Mirror**  
40"h 36"w

**MI-3131 Mirror**  
40"h 46"w

**MI-3132 Mirror**  
32"h 42"w

**MI-3133 Mirror**  
32"h 52"w

Beveled Mirror

# Rosedale Bed Frames



Shown with and **Regular Footboard**

## Rosedale Bed

### Regular Footboard

Available  
with underbed  
storage options.

**RD-3165-K** (King)  
82½"w 87"l  
HB 58"h ■ FB 18"h

**RD-3165-Q** (Queen)  
66½"w 87"l  
HB 58"h ■ FB 18"h

**RD-3165-F** (Full)  
59¾"w 82"l  
HB 58"h ■ FB 18"h

**RD-3165-T** (Twin)  
44½"w 82"l  
HB 58"h ■ FB 18"h

### Low Footboard

**RD-3166-K** (King)  
82½"w 85¼"l  
HB 58"h ■ FB 14¾"h

**RD-3166-Q** (Queen)  
66½"w 85¼"l  
HB 58"h ■ FB 14¾"h

**RD-3166-F** (Full)  
59¾"w 80¼"l  
HB 58"h ■ FB 14¾"h

**RD-3166-T** (Twin)  
44½"w 80¼"l  
HB 58"h ■ FB 14¾"h

### Headboard Only

**RD-3167K-HB** (King)  
58" high

**RD-3167Q-HB** (Queen)  
58" high

**RD-3167F-HB** (Full)  
58" high

**RD-3167T-HB** (Twin)  
58" high

# Rosedale Storage Rail Upgrades

## 12<sup>3</sup>/<sub>4</sub>" From Floor to Box Spring

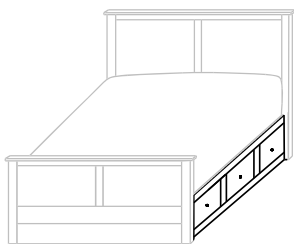

- With 3 drawers on each side
- 12<sup>3</sup>/<sub>4</sub>" from floor to Box Spring
- Inside drawer dimensions on all sizes  
9<sup>1</sup>/<sub>4</sub>"h 18<sup>7</sup>/<sub>8</sub>"w 22<sup>1</sup>/<sub>2</sub>"d

**532-SR-K** King – 6 drawers  
**532-SR-Q** Queen – 6 drawers  
**532-SR-F** Full – 6 drawers  
**532-SR-T** Twin – 3 drawers

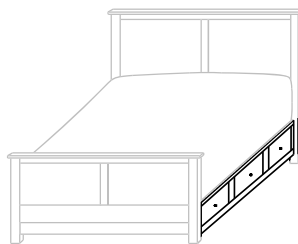

- With 3" Toe Kick
- With 3 drawers on each side
- 12<sup>3</sup>/<sub>4</sub>" from floor to Box Spring
- Inside drawer dimensions on all sizes  
6<sup>1</sup>/<sub>4</sub>"h 18<sup>7</sup>/<sub>8</sub>"w 22<sup>1</sup>/<sub>2</sub>"d

**234-SR-K** King – 6 drawers  
**234-SR-Q** Queen – 6 drawers  
**234-SR-F** Full – 6 drawers  
**234-SR-T** Twin – 3 drawers

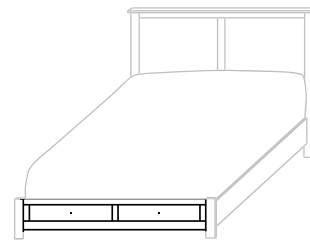

- 12<sup>3</sup>/<sub>4</sub>" from floor to Box Spring
- Inside drawer dimensions  
6<sup>1</sup>/<sub>4</sub>"h 22<sup>1</sup>/<sub>2</sub>"d  
 (King) 31"w      (Queen) 23<sup>1</sup>/<sub>4</sub>"w  
 (Full) 19<sup>5</sup>/<sub>8</sub>"w      (Twin) 29<sup>1</sup>/<sub>4</sub>"w

**685-FDS-K** King – 2 drawers  
**685-FDS-Q** Queen – 2 drawers  
**685-FDS-F** Full – 2 drawers  
**685-FDS-T** Twin – 1 drawer

## 19<sup>3</sup>/<sub>4</sub>" From Floor to Box Spring

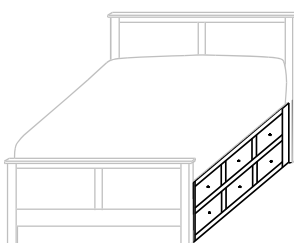

- With 6 drawers on each side
- Twin has 6 drawers on 1 side only
- 19<sup>3</sup>/<sub>4</sub>" from floor to Box Spring
- Inside drawer dimensions on all sizes  
6<sup>1</sup>/<sub>4</sub>"h 18<sup>7</sup>/<sub>8</sub>"w 22<sup>1</sup>/<sub>2</sub>"d

**654-SR-K** King – 12 drawers  
**654-SR-Q** Queen – 12 drawers  
**654-SR-F** Full – 12 drawers  
**654-SR-T** Twin – 6 drawers

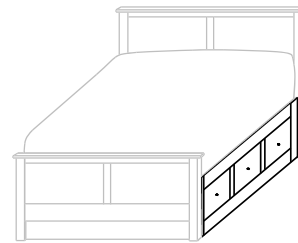

- With 3 drawers on each side
- 19<sup>3</sup>/<sub>4</sub>" from floor to Box Spring
- Inside drawer dimensions on all sizes  
10<sup>1</sup>/<sub>4</sub>"h 18<sup>7</sup>/<sub>8</sub>"w 22<sup>1</sup>/<sub>2</sub>"d

**325-SR-K** King – 6 drawers  
**325-SR-Q** Queen – 6 drawers  
**325-SR-F** Full – 6 drawers  
**325-SR-T** Twin – 3 drawers

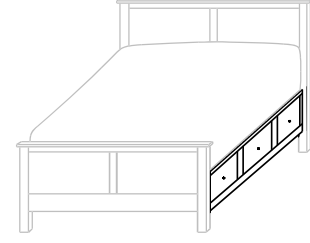

- With 7" Toe Kick
- With 3 drawers on each side
- 19<sup>3</sup>/<sub>4</sub>" from floor to Box Spring
- Inside drawer dimensions on all sizes  
9<sup>1</sup>/<sub>4</sub>"h 18<sup>7</sup>/<sub>8</sub>"w 22<sup>1</sup>/<sub>2</sub>"d

**236-SR-K** King – 6 drawers  
**236-SR-Q** Queen – 6 drawers  
**236-SR-F** Full – 6 drawers  
**236-SR-T** Twin – 3 drawers

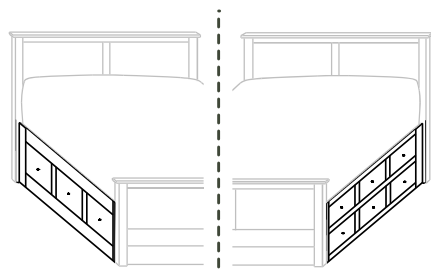

- With 3 drawers on one side and 6 drawers on other side
- 19<sup>3</sup>/<sub>4</sub>" from floor to Box Spring

**420-SR-K** King – 9 drawers  
**420-SR-Q** Queen – 9 drawers  
**420-SR-F** Full – 9 drawers  
 (Twin Not Available)

### Additional Upgrades

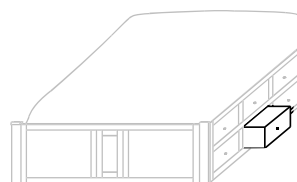

- With Step Stool Pullout in place of drawer

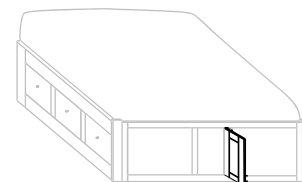

- With Door in Footboard to access area between rails





*Shoreview*  
Bedroom Collection

# Shoreview



## Shoreview Bedroom Collection w/Shoreview Bed

- SH-2090Q Queen Bed
- SH-2011 Night Stand
- SH-2026 Chest
- SH-2030 Dresser
- MI-2430 Mirror

Shown above in **Brown Maple** with **OCS-113 Michael** and **K800-SN Knobs**

### Standard Features:



K800-SN Knobs



Standard with side-mount drawer slides

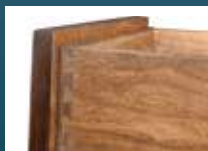

Stained poplar drawer boxes



Dovetailed bed slats



- SH-2090Q Shoreview Bed
- SH-2011 Night Stand
- SH-2026 Chest
- SH-2030 Dresser
- MI-2430 Mirror

*Shown in Brown Maple  
FC-47872 Bel-Aire and  
K800-SN Hardware*

### Available Upgrades:

- Any hardware on our Hardware Options Sheet
- Undermount soft close slides [See Price List]

# Shoreview Night Stands



**SH-2016**  
Night Stand shown



Sliding top option available on all night stands  
(Hidden compartment w/Lock)

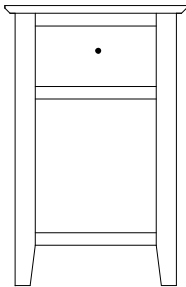

**SH-2011 Night Stand**  
18"w 27¾"h 18"d  
w/1 drawer

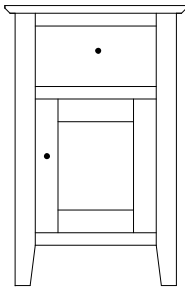

**SH-2012 Night Stand**  
18"w 27¾"h 18"d  
w/1 drawer, 1 door

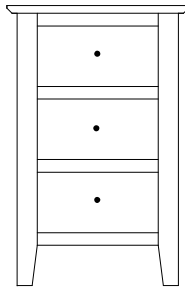

**SH-2013 Night Stand**  
18"w 27¾"h 18"d  
w/3 drawers

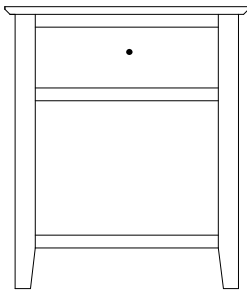

**SH-2014 Night Stand**  
24"w 27¾"h 18"d  
w/1 drawer

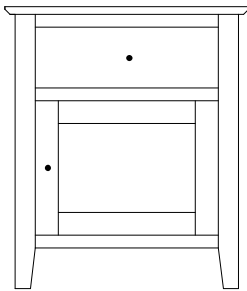

**SH-2015 Night Stand**  
24"w 27¾"h 18"d  
w/1 drawer, 1 door

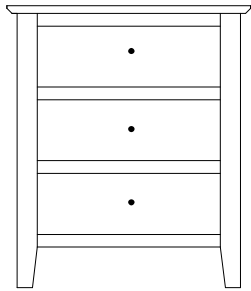

**SH-2016 Night Stand**  
24"w 27¾"h 18"d  
w/3 drawers

# Shoreview Lingeries & Chests



**SH-2026**  
Chest shown

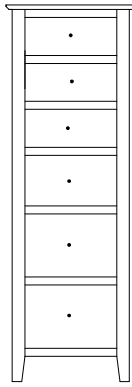

**SH-2017 Lingerie**  
20½"w 59½"h 19½"d  
w/6 drawers

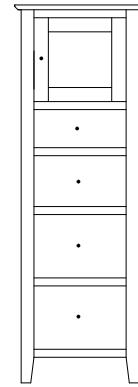

Available with  
mirror in  
door panel

**SH-2018 Lingerie**  
20½"w 59½"h 19½"d  
w/4 drawers, 1 wood door,  
1 adjustable shelf



**SH-2049 Chest**  
36¼"w 35¾"h 19½"d  
w/3 drawers

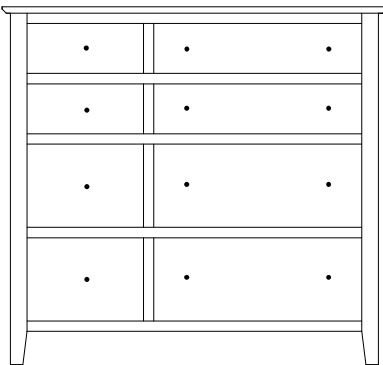

**SH-2041 Chest**  
46¼"w 43"h 19½"d  
w/8 drawers

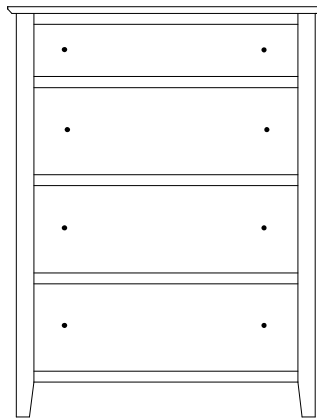

**SH-2026 Chest**  
36¼"w 47"h 19½"d  
w/4 drawers

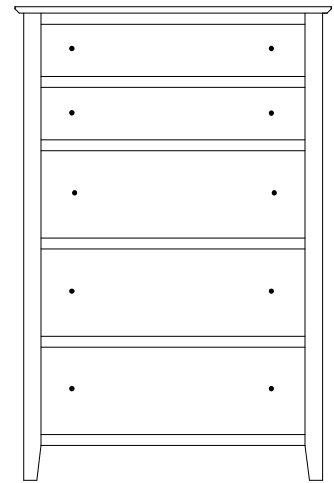

**SH-2027 Hi-Boy**  
36¼"w 54¼"h 19½"d  
w/5 drawers

# Shoreview Miscellaneous

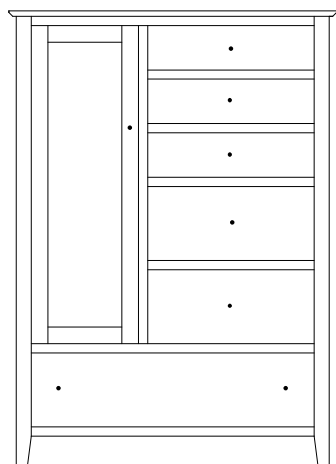

Option:  
Mirror on  
back of door

**SH-2028 Chifferobe**  
44 1/4"w 61 1/2"h 19 1/2"d  
w/6 drawers, 1 door, 2 adj. shelves

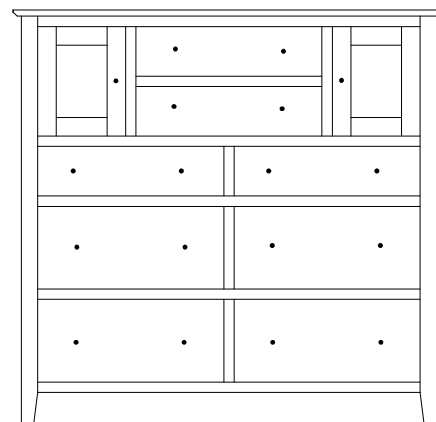

**SH-2047 His & Hers**  
52 1/2"w 50 1/4"h 19 1/2"d  
w/8 drawers, 2 doors

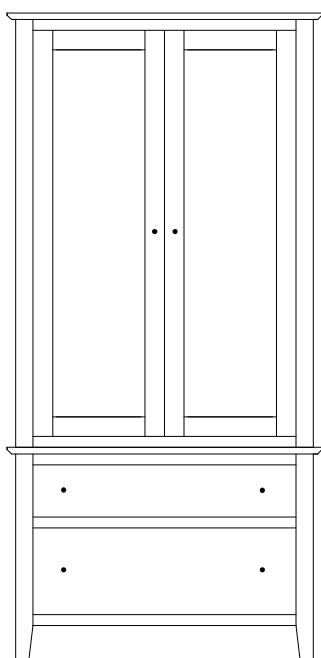

**SH-2062 Armoire**  
36 1/4"w 78"h 19 1/2"d  
w/2 drawers, w/2 doors  
2 adj. shelves & closet rod

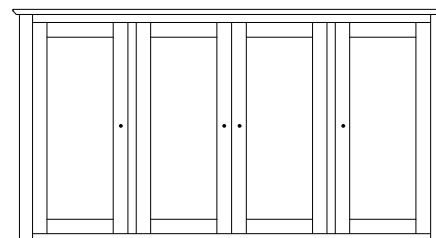

**SH-2059 Mule Chest Top**  
67 3/4"w 35"h 19 1/2"d  
w/4 doors & 6 adjustable shelves

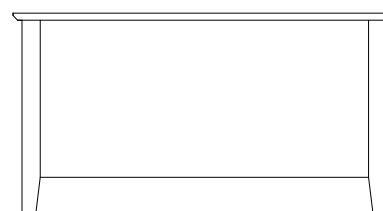

**SH-2035 Blanket Chest**  
42"w 22"h 19 1/2"d

Available  
with aromatic  
cedar bottom

# Shoreview Dressers



SH-2030 Dresser shown with MI-2430 Mirror

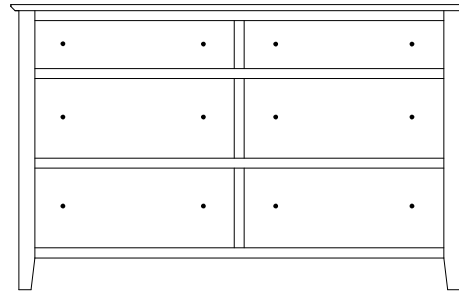

**SH-2030 Dresser**  
57 1/4"w 35 3/4"h 19 1/2"d  
w/6 drawers

Suggested Mirrors:

**MI-2430 Mirror**  
40"h 36"w

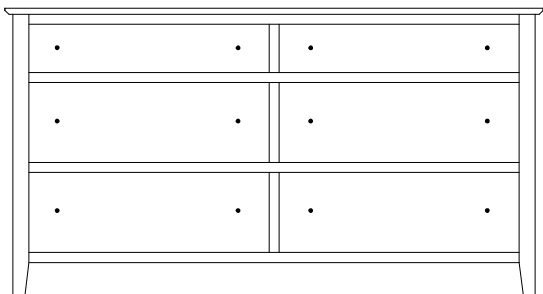

**SH-2031 Dresser**  
67 3/4"w 35 3/4"h 19 1/2"d  
w/6 drawers

Suggested Mirrors:

**MI-2431 Mirror**  
40"h 46"w

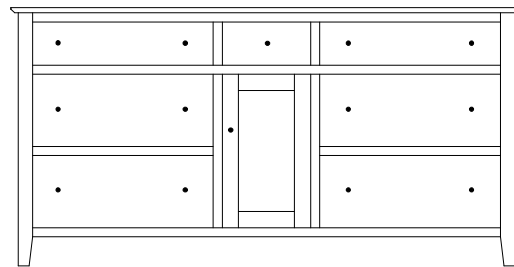

**SH-2032 Dresser**  
70 3/4"w 35 3/4"h 19 1/2"d  
w/7 drawers, 1 door  
w/1 adjustable shelf

Suggested Mirrors:

**MI-2431 Mirror**  
40"h 46"w

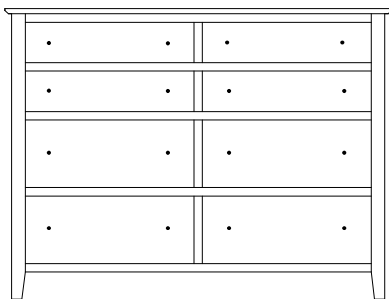

**SH-2043 Tall Dresser**  
57 1/4"w 43"h 19 1/2"d  
w/8 drawers

Suggested Mirrors:

**MI-2432 Mirror**  
32"h 42"w

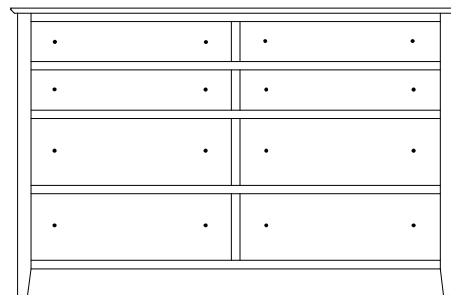

**SH-2044 Tall Dresser**  
67 3/4"w 43"h 19 1/2"d  
w/8 drawers

Suggested Mirrors:

**MI-2433 Mirror**  
32"h 52"w



Plain Mirror

**MI-2430 Mirror**  
40"high 36"wide

**MI-2431 Mirror**  
40"high 46"wide

**MI-2432 Mirror**  
32"high 42"wide

**MI-2433 Mirror**  
32"high 52"wide

# Shoreview Bed Frames



shown with Regular Footboard

## Shoreview Beds

Available  
with underbed  
storage options.

### Regular Footboard

**SH-2088-K (King)**  
81½"w 85½"l  
HB 48"h ■ FB 30"h

**SH-2088-Q (Queen)**  
66"w 85½"l  
HB 48"h ■ FB 30"h

**SH-2088-F (Full)**  
58¾"w 80½"l  
HB 48"h ■ FB 30"h

**SH-2088-T (Twin)**  
44"w 80½"l  
HB 48"h ■ FB 30"h

### Low Footboard

**SH-2090-K (King)**  
81½"w 84½"l  
HB 48"h ■ FB 14¾"h

**SH-2090-Q (Queen)**  
66"w 84½"l  
HB 48"h ■ FB 14¾"h

**SH-2090-F (Full)**  
58¾"w 79½"l  
HB 48"h ■ FB 14¾"h

**SH-2090-T (Twin)**  
44"w 79½"l  
HB 48"h ■ FB 14¾"h

### Headboard Only

**SH-2098-HB-K (King)**  
48" high

**SH-2098-HB-Q (Queen)**  
48" high

**SH-2098-HB-F (Full)**  
48" high

**SH-2098-HB-T (Twin)**  
48" high

# Shoreview Storage Rail Upgrades

## 12<sup>3</sup>/<sub>4</sub>" From Floor to Box Spring

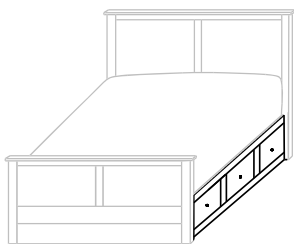

- With 3 drawers on each side
- 12<sup>3</sup>/<sub>4</sub>" from floor to Box Spring
- Inside drawer dimensions on all sizes  
9<sup>1</sup>/<sub>4</sub>"h 18<sup>7</sup>/<sub>8</sub>"w 22<sup>1</sup>/<sub>2</sub>"d

**532-SR-K** King – 6 drawers  
**532-SR-Q** Queen – 6 drawers  
**532-SR-F** Full – 6 drawers  
**532-SR-T** Twin – 3 drawers

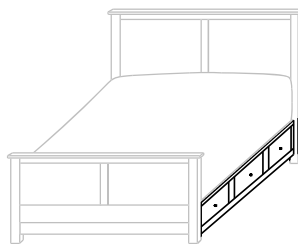

- With 3" Toe Kick
- With 3 drawers on each side
- 12<sup>3</sup>/<sub>4</sub>" from floor to Box Spring
- Inside drawer dimensions on all sizes  
6<sup>1</sup>/<sub>4</sub>"h 18<sup>7</sup>/<sub>8</sub>"w 22<sup>1</sup>/<sub>2</sub>"d

**234-SR-K** King – 6 drawers  
**234-SR-Q** Queen – 6 drawers  
**234-SR-F** Full – 6 drawers  
**234-SR-T** Twin – 3 drawers

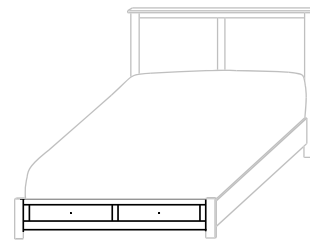

- 12<sup>3</sup>/<sub>4</sub>" from floor to Box Spring
- Inside drawer dimensions  
6<sup>1</sup>/<sub>4</sub>"h 22<sup>1</sup>/<sub>2</sub>"d  
 (King) 31"w      (Queen) 23<sup>1</sup>/<sub>4</sub>"w  
 (Full) 19<sup>5</sup>/<sub>8</sub>"w      (Twin) 29<sup>1</sup>/<sub>4</sub>"w

**685-FDS-K** King – 2 drawers  
**685-FDS-Q** Queen – 2 drawers  
**685-FDS-F** Full – 2 drawers  
**685-FDS-T** Twin – 1 drawer

## 19<sup>3</sup>/<sub>4</sub>" From Floor to Box Spring

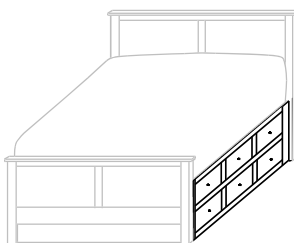

- With 6 drawers on each side
- Twin has 6 drawers on 1 side only
- 19<sup>3</sup>/<sub>4</sub>" from floor to Box Spring
- Inside drawer dimensions on all sizes  
6<sup>1</sup>/<sub>4</sub>"h 18<sup>7</sup>/<sub>8</sub>"w 22<sup>1</sup>/<sub>2</sub>"d

**654-SR-K** King – 12 drawers  
**654-SR-Q** Queen – 12 drawers  
**654-SR-F** Full – 12 drawers  
**654-SR-T** Twin – 6 drawers

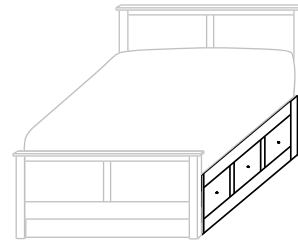

- With 3 drawers on each side
- 19<sup>3</sup>/<sub>4</sub>" from floor to Box Spring
- Inside drawer dimensions on all sizes  
10<sup>1</sup>/<sub>4</sub>"h 18<sup>7</sup>/<sub>8</sub>"w 22<sup>1</sup>/<sub>2</sub>"d

**325-SR-K** King – 6 drawers  
**325-SR-Q** Queen – 6 drawers  
**325-SR-F** Full – 6 drawers  
**325-SR-T** Twin – 3 drawers

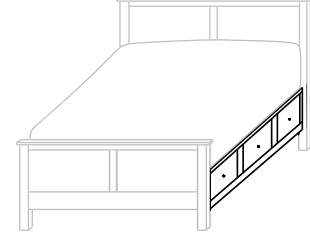

- With 7" Toe Kick
- With 3 drawers on each side
- 19<sup>3</sup>/<sub>4</sub>" from floor to Box Spring
- Inside drawer dimensions on all sizes  
9<sup>1</sup>/<sub>4</sub>"h 18<sup>7</sup>/<sub>8</sub>"w 22<sup>1</sup>/<sub>2</sub>"d

**236-SR-K** King – 6 drawers  
**236-SR-Q** Queen – 6 drawers  
**236-SR-F** Full – 6 drawers  
**236-SR-T** Twin – 3 drawers

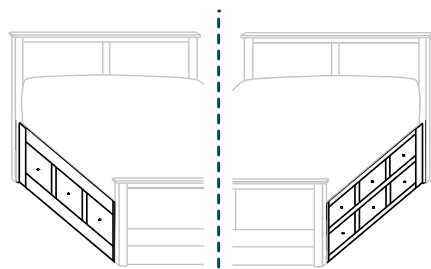

- With 3 drawers on one side and 6 drawers on other side
- 19<sup>3</sup>/<sub>4</sub>" from floor to Box Spring

**420-SR-K** King – 9 drawers  
**420-SR-Q** Queen – 9 drawers  
**420-SR-F** Full – 9 drawers  
 (Twin Not Available)

### Additional Upgrades

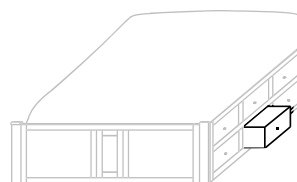

- With Step Stool Pullout in place of drawer

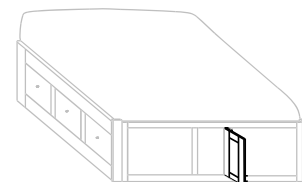

- With Door in Footboard to access area between rails





MAKE YOURSELF  
COMFORTABLE



*Sonora*  
Bedroom Collection

# Sonora



## Sonora Bedroom Collection w/Sleepwell Bed

- SW-493Q Queen Bed
- TB-61 Night Stand
- SO-162 Chest
- SO-163 Dresser
- MI-2130 Mirror

Shown above in **Brown Maple** with **OCS-117 Asbury** and **1½" Wood Knobs**

### Standard Features:



1½" Wood Knobs



Standard with side-mount drawer slides



Stained poplar drawer boxes



Dovetailed bed slats

### Available Upgrades:

- Any hardware on our Hardware Options Sheet
- Undermount soft close slides [See Price List]



- SO-1050Q Panel Bed
- SO-116 Night Stand
- SO-162 Chest
- SO-144 Tall Dresser
- MI-2133 Mirror

*Shown in Rustic Cherry with OCS-117 Asbury and 44-4281-191 Hardware*

# Sonora Night Stands



**SO-116**  
Night Stand shown



Sliding top option available on all night stands  
(Hidden compartment w/Lock)

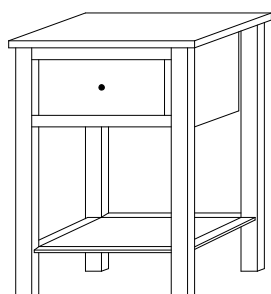

**TB-61 Night Stand**  
20¼"w 27½"h 19¼"d  
w/1 drawer

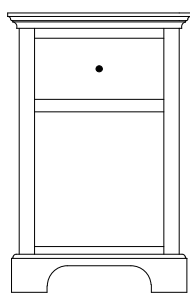

**SO-111 Night Stand**  
18"w 27½"h 19"d  
w/1 drawer

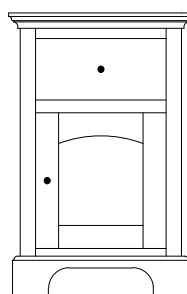

**SO-112 Night Stand**  
18"w 27½"h 19"d  
w/1 drawer, 1 door

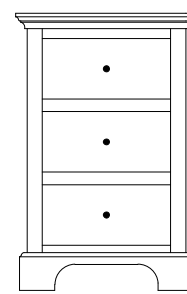

**SO-113 Night Stand**  
18"w 27½"h 19"d  
w/3 drawers

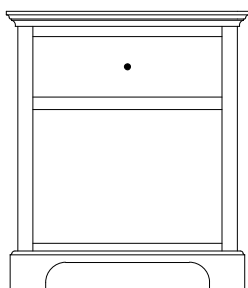

**SO-114 Night Stand**  
24"w 27½"h 19"d  
w/1 drawer

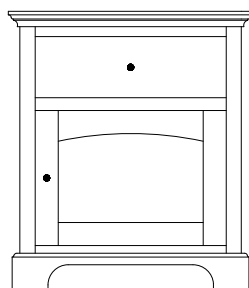

**SO-115 Night Stand**  
24"w 27½"h 19"d  
w/1 drawer, 1 door

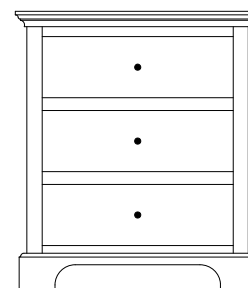

**SO-116 Night Stand**  
24"w 27½"h 19"d  
w/3 drawers

# Sonora Lingeries & Chests



**SO-162**  
Chest shown

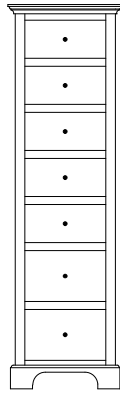

**SO-117 Lingerie**  
18"w 60½"h 21"d  
w/7 drawers

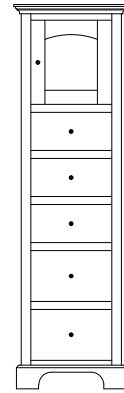

Available with  
mirror panel  
in door (SO-119)

**SO-118 Lingerie**  
18"w 60½"h 21"d  
w/5 drawers, 1 wood door,  
1 adjustable shelf

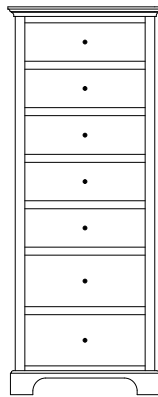

**SO-120 Lingerie**  
24"w 60½"h 21"d  
w/7 drawers

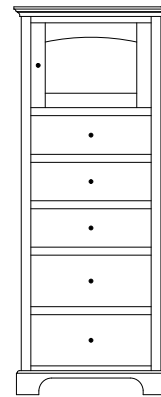

Available with  
mirror panel  
in door (SO-122)

**SO-121 Lingerie**  
24"w 60½"h 21"d  
w/5 drawers, 1 wood door,  
1 adjustable shelf

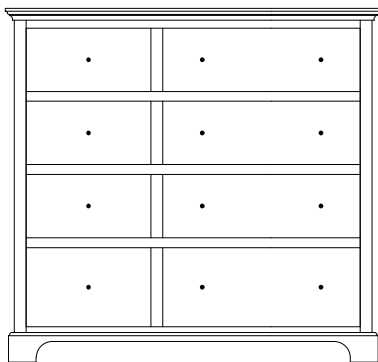

**SO-141 Chest**  
48"w 44¾"h 21"d  
w/8 drawers

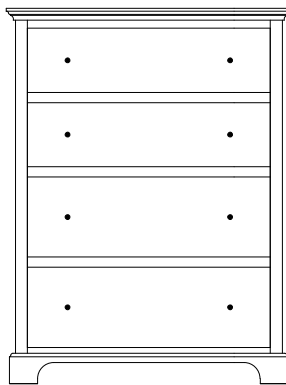

**SO-126 Chest**  
36"w 46¾"h 21"d  
w/4 drawers

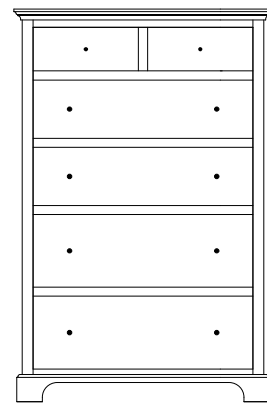

**SO-162 Chest**  
36"w 54"h 21"d  
w/6 drawers

# Sonora Miscellaneous

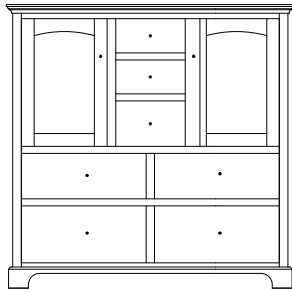

**SO-147 His & Hers**  
51¼"w 50"h 21"d  
w/7 drawers, 2 doors, 2 adj. shelves

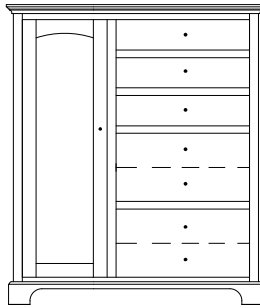

**SO-128 Chifferobe**  
43¼"w 49½"h 21"d  
w/5 drawers, 1 door, 2 adj. shelves

Option:  
Mirror on  
back of door

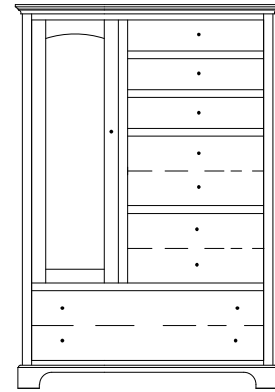

**SO-129 Chifferobe**  
43¼"w 62"h 21"d  
w/6 drawers, 1 door, 2 adj. shelves

Option:  
Mirror on  
back of door

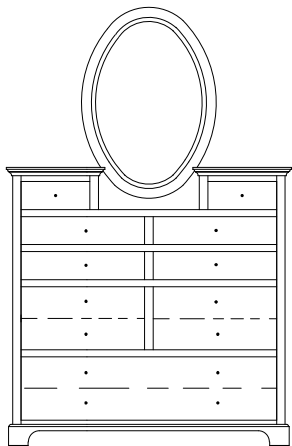

**SO-136 Studio w/Mirror**  
51¼"w 80"h 21"d  
w/9 drawers

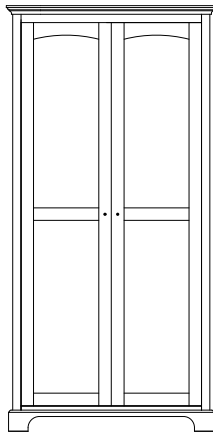

**SO-159 Wardrobe**  
39"w 76"h 25½"d  
w/2 doors, closet rod

Option:  
Adjustable shelves  
Full width drawer  
inside doors in  
bottom of unit

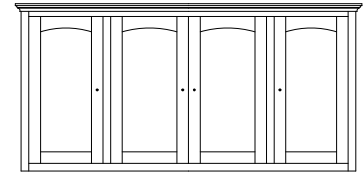

**SO-35 Mule Chest Top**  
68¾"w 35½"h 21½"d  
w/4 doors & 4 adjustable shelves

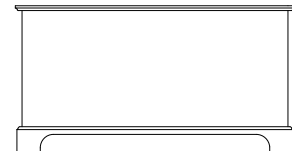

**SO-164 Blanket Chest**  
42"w 22"h 21½"d

Available  
with aromatic  
cedar bottom

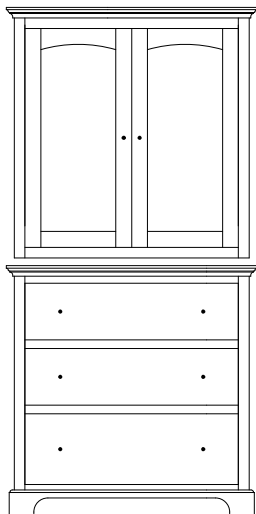

**SO-25 Armoire Top**  
37"w 35½"h 21½"d  
w/2 doors, 2 adj. shelves  
w/1 wire hole in back

**SO-123 Armoire Base**  
36"w 35½"h 21"d  
w/3 drawers

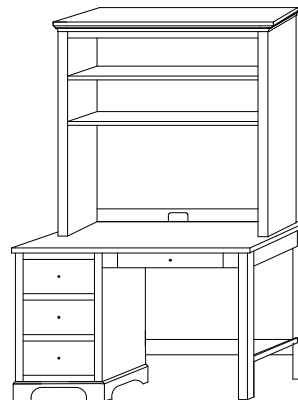

**SO-197 Study Carrel**  
48"w 42"h 13"d  
w/2 adjustable shelves

**SO-199 Student Desk**  
48"w 29¼"h 22½"d  
w/3 drawers  
w/1 pencil drawer

Upgrades available on student desk:

Keyboard slideout instead of pencil drawer  
File drawer instead of bottom 2 drawers

# Sonora Dressers



**SO-163 Dresser** shown with **MI-2130 Mirror**

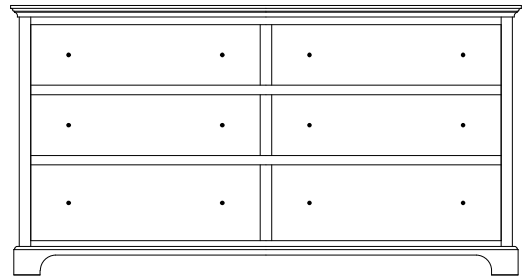

**SO-131 Dresser**  
67¾"w 35½"h 21"d  
w/6 drawers

Suggested Mirrors:

**MI-2131 Mirror**  
40"h 46"w

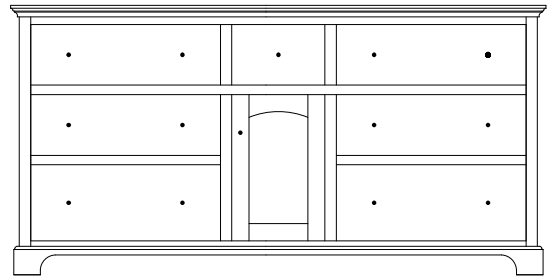

**SO-132 Dresser**  
71"w 35½"h 21"d  
w/7 drawers, 1 door,  
1 adjustable shelf

Suggested Mirrors:

**MI-2131 Mirror**  
40"h 46"w

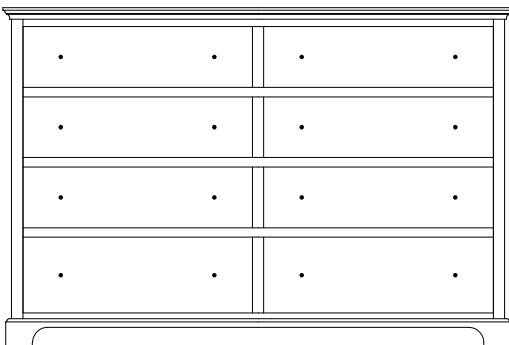

**SO-134 Dresser**  
67¾"w 46¾"h 21"d  
w/8 drawers

Suggested Mirrors:

**MI-2133 Mirror**  
32"h 52"w

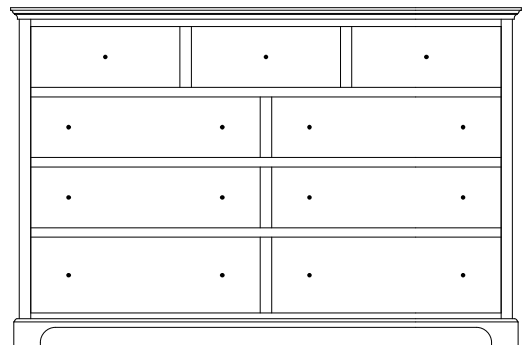

**SO-144 Dresser**  
67¾"w 44¾"h 21"d  
w/9 drawers

Suggested Mirrors:

**MI-2133 Mirror**  
32"h 52"w

# Sonora Dressers

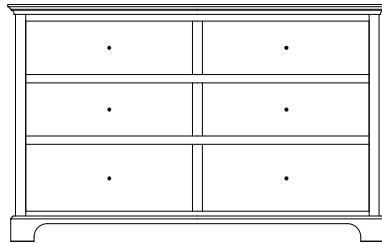

**SO-130 Dresser**  
57¼"w 35½"h 21"d  
w/6 drawers

Suggested Mirrors:

**MI-2131 Mirror**  
40"h 46"w

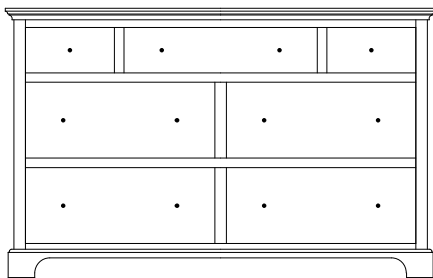

**SO-163 Dresser**  
57¼"w 35½"h 21"d  
w/7 drawers

Suggested Mirrors:

**MI-2130 Mirror**  
40"h 36"w

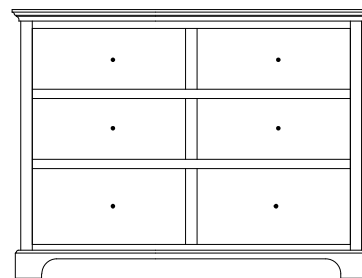

**SO-165 Dresser**  
47¾"w 33½"h 21"d  
w/6 drawers

Suggested Mirrors:

**MI-2130 Mirror**  
40"h 36"w

# Sonora Mirror



Beveled Mirror

**MI-2130 Mirror**  
40"high 36"wide

**MI-2131 Mirror**  
40"high 46"wide

**MI-2132 Mirror**  
32"high 42"wide

**MI-2133 Mirror**  
32"high 52"wide

# Sonora Bed Frames



shown with Regular Footboard



shown with Regular Footboard

## Panel Bed

### Regular Footboard

Available with underbed storage options.

**SO-1050-K** (King)

82¼" w 87½" l

HB 52¾" h ■ FB 30¾" h

**SO-1050-Q** (Queen)

66⅝" w 87½" l

HB 52¾" h ■ FB 30¾" h

**SO-1050-F** (Full)

59½" w 82⅝" l

HB 52¾" h ■ FB 30¾" h

**SO-1050-T** (Twin)

44¾" w 82⅝" l

HB 52¾" h ■ FB 30¾" h

### Low Footboard

**SO-1052-K** (King)

82¼" w 85¾" l

HB 52¾" h ■ FB 14¾" h

**SO-1052-Q** (Queen)

66⅝" w 85¾" l

HB 52¾" h ■ FB 14¾" h

**SO-1052-F** (Full)

59½" w 80¾" l

HB 52¾" h ■ FB 14¾" h

**SO-1052-T** (Twin)

44¾" w 80¾" l

HB 52¾" h ■ FB 14¾" h

### Headboard Only

**SO-1054K-HB** (King)

52¾" high

**SO-1054Q-HB** (Queen)

52¾" high

**SO-1054F-HB** (Full)

52¾" high

**SO-1054T-HB** (Twin)

52¾" high

## Sleepwell Bed

### Regular Footboard

Available with underbed storage options.

**SW-491-K** (King)

79⅝" w 84½" l

HB 48" h ■ FB 30" h

**SW-491-Q** (Queen)

64⅝" w 84½" l

HB 48" h ■ FB 30" h

**SW-491-F** (Full)

56⅞" w 79½" l

HB 48" h ■ FB 30" h

**SW-491-T** (Twin)

42" w 79½" l

HB 48" h ■ FB 30" h

### Low Footboard

**SW-493-K** (King)

79⅝" w 84½" l

HB 48" h ■ FB 14¾" h

**SW-493-Q** (Queen)

64⅝" w 84½" l

HB 48" h ■ FB 14¾" h

**SW-493-F** (Full)

56⅞" w 79½" l

HB 48" h ■ FB 14¾" h

**SW-493-T** (Twin)

42" w 79½" l

HB 48" h ■ FB 14¾" h

### Headboard Only

**SW-495K-HB** (King)

48" high

**SW-495Q-HB** (Queen)

48" high

**SW-495F-HB** (Full)

48" high

**SW-495T-HB** (Twin)

48" high

# Sonora Storage Rail Upgrades

## 12<sup>3</sup>/<sub>4</sub>" From Floor to Box Spring

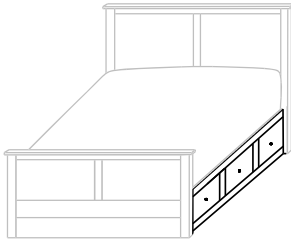

- With 3 drawers on each side
- 12<sup>3</sup>/<sub>4</sub>" from floor to Box Spring
- Inside drawer dimensions on all sizes  
9<sup>1</sup>/<sub>4</sub>"h 18<sup>7</sup>/<sub>8</sub>"w 22<sup>1</sup>/<sub>2</sub>"d

**532-SR-K** King – 6 drawers  
**532-SR-Q** Queen – 6 drawers  
**532-SR-F** Full – 6 drawers  
**532-SR-T** Twin – 3 drawers

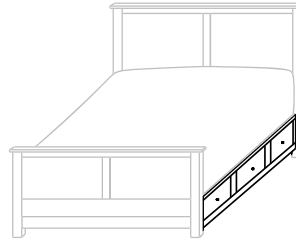

- With 3" Toe Kick
- With 3 drawers on each side
- 12<sup>3</sup>/<sub>4</sub>" from floor to Box Spring
- Inside drawer dimensions on all sizes  
6<sup>1</sup>/<sub>4</sub>"h 18<sup>7</sup>/<sub>8</sub>"w 22<sup>1</sup>/<sub>2</sub>"d

**234-SR-K** King – 6 drawers  
**234-SR-Q** Queen – 6 drawers  
**234-SR-F** Full – 6 drawers  
**234-SR-T** Twin – 3 drawers

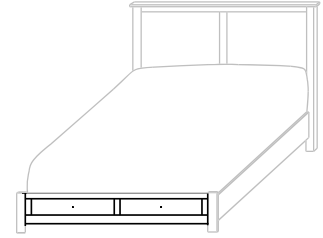

- 12<sup>3</sup>/<sub>4</sub>" from floor to Box Spring
- Inside drawer dimensions  
6<sup>1</sup>/<sub>4</sub>"h 22<sup>1</sup>/<sub>2</sub>"d  
 (King) 31"w      (Queen) 23<sup>1</sup>/<sub>4</sub>"w  
 (Full) 19<sup>5</sup>/<sub>8</sub>"w      (Twin) 29<sup>1</sup>/<sub>4</sub>"w

**685-FDS-K** King – 2 drawers  
**685-FDS-Q** Queen – 2 drawers  
**685-FDS-F** Full – 2 drawers  
**685-FDS-T** Twin – 1 drawer

## 19<sup>3</sup>/<sub>4</sub>" From Floor to Box Spring

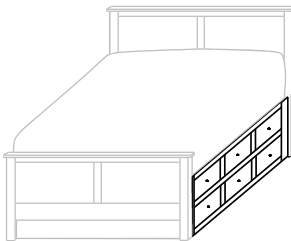

- With 6 drawers on each side
- Twin has 6 drawers on 1 side only
- 19<sup>3</sup>/<sub>4</sub>" from floor to Box Spring
- Inside drawer dimensions on all sizes  
6<sup>1</sup>/<sub>4</sub>"h 18<sup>7</sup>/<sub>8</sub>"w 22<sup>1</sup>/<sub>2</sub>"d

**654-SR-K** King – 12 drawers  
**654-SR-Q** Queen – 12 drawers  
**654-SR-F** Full – 12 drawers  
**654-SR-T** Twin – 6 drawers

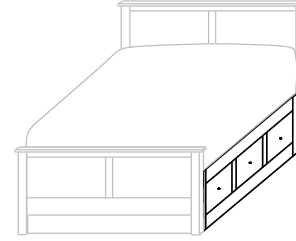

- With 3 drawers on each side
- 19<sup>3</sup>/<sub>4</sub>" from floor to Box Spring
- Inside drawer dimensions on all sizes  
10<sup>1</sup>/<sub>4</sub>"h 18<sup>7</sup>/<sub>8</sub>"w 22<sup>1</sup>/<sub>2</sub>"d

**325-SR-K** King – 6 drawers  
**325-SR-Q** Queen – 6 drawers  
**325-SR-F** Full – 6 drawers  
**325-SR-T** Twin – 3 drawers

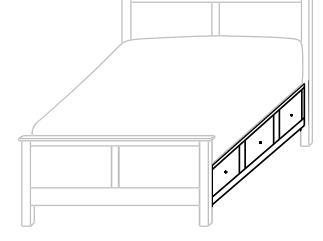

- With 7" Toe Kick
- With 3 drawers on each side
- 19<sup>3</sup>/<sub>4</sub>" from floor to Box Spring
- Inside drawer dimensions on all sizes  
9<sup>1</sup>/<sub>4</sub>"h 18<sup>7</sup>/<sub>8</sub>"w 22<sup>1</sup>/<sub>2</sub>"d

**236-SR-K** King – 6 drawers  
**236-SR-Q** Queen – 6 drawers  
**236-SR-F** Full – 6 drawers  
**236-SR-T** Twin – 3 drawers

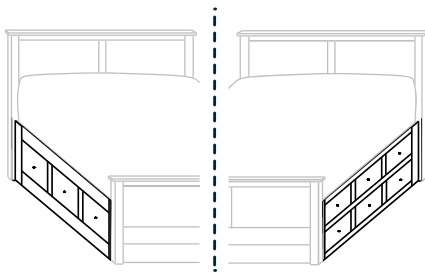

- With 3 drawers on one side and 6 drawers on other side
- 19<sup>3</sup>/<sub>4</sub>" from floor to Box Spring

**420-SR-K** King – 9 drawers  
**420-SR-Q** Queen – 9 drawers  
**420-SR-F** Full – 9 drawers  
 (Twin Not Available)

### Additional Upgrades

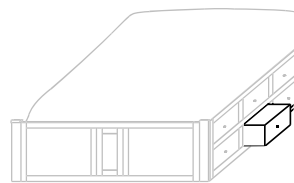

- With Step Stool Pullout in place of drawer

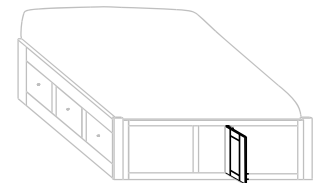

- With Door in Footboard to access area between rails





*Timber Mill*  
Bedroom Collection

# Timber Mill



## Timber Mill Bedroom Collection

- TM-3365Q Queen Bed w/FDS 685 Upgrade
- TM-3342 Night Stand
- TM-3350 Chest
- TM-3358 Dresser
- MI-3333 Mirror

Features: 1¼" Plank Tops with Breadboard ends & Random Saw Marks

Shown above in **Rustic Cherry** with **105 Black Walnut** with **P2170-BI Knobs** and **P2171-BI Pulls**

### Standard Features:



P2170-BI Knobs & P2171-BI Pulls



Standard with side-mount drawer slides



Stained poplar dovetailed drawers



Dovetailed bed slats

### Available Upgrades:

- Any hardware on our Hardware Options Sheet
- Undermount soft close slides [See Price List]



- HT-2125Q Queen Bed
- TM-3345 Night Stand
- TM-3351 Hi-Boy
- TM-3357 Dresser
- MI-3332 Mirror

Shown in **Rustic Hickory Natural** with **FG-20018 Glaze** and **P2170-BI Knobs** and **P2171-BI Pulls**

# Timber Mill Night Stands



**TM-3345**  
Night Stand shown



**Sliding Top Option available  
in all Nightstands**  
(Hidden compartment w/lock)

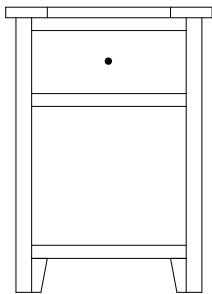

**TM-3340 Night Stand**  
19 $\frac{3}{4}$ "w 27 $\frac{1}{2}$ "h 17 $\frac{1}{2}$ "d  
w/1 drawer

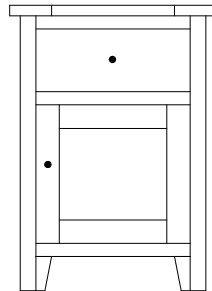

**TM-3341 Night Stand**  
19 $\frac{3}{4}$ "w 27 $\frac{1}{2}$ "h 17 $\frac{1}{2}$ "d  
w/1 drawer, 1 door

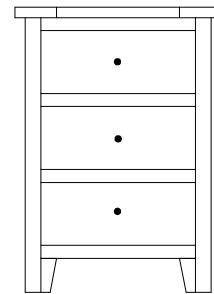

**TM-3342 Night Stand**  
19 $\frac{3}{4}$ "w 27 $\frac{1}{2}$ "h 17 $\frac{1}{2}$ "d  
w/3 drawers

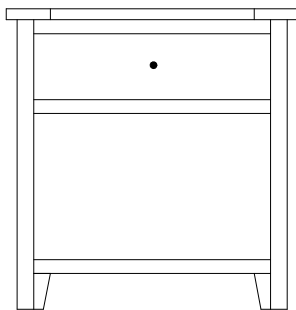

**TM-3343 Night Stand**  
26 $\frac{1}{2}$ "w 27 $\frac{1}{2}$ "h 17 $\frac{1}{2}$ "d  
w/1 drawer

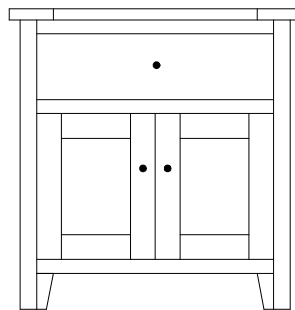

**TM-3344 Night Stand**  
26 $\frac{1}{2}$ "w 27 $\frac{1}{2}$ "h 17 $\frac{1}{2}$ "d  
w/1 drawer, 2 doors

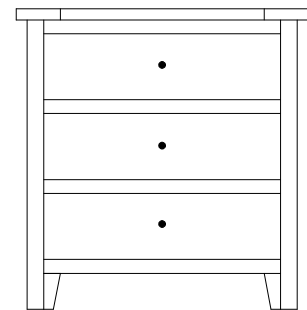

**TM-3345 Night Stand**  
26 $\frac{1}{2}$ "w 27 $\frac{1}{2}$ "h 17 $\frac{1}{2}$ "d  
w/3 drawers

# Timber Mill Lingeries & Chests



**TM-351**  
Hi-Boy shown

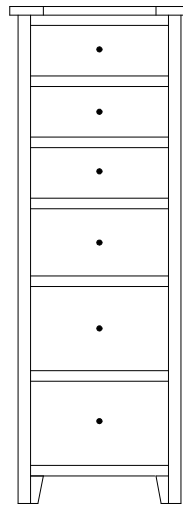

**TM-3346 Lingerie**  
21 $\frac{3}{8}$ "w 59 $\frac{1}{4}$ "h 21 $\frac{1}{2}$ "d  
w/6 drawers

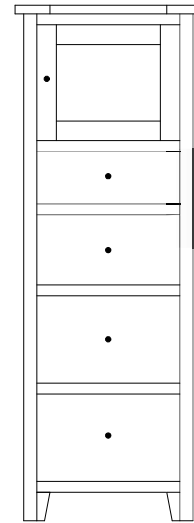

Available with  
mirror in  
door panel

**TM-3347 Lingerie**  
21 $\frac{3}{8}$ "w 59 $\frac{1}{4}$ "h 21 $\frac{1}{2}$ "d  
w/4 drawers, 1 wood door,  
1 adjustable shelf

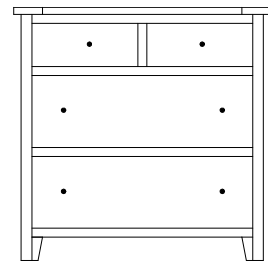

**TM-3349 Chest**  
35 $\frac{3}{4}$ "w 35 $\frac{1}{2}$ "h 21 $\frac{1}{2}$ "d  
w/4 drawers

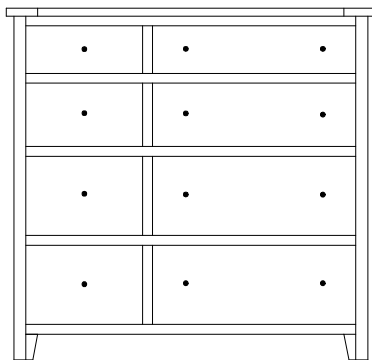

**TM-3348 Chest**  
46 $\frac{3}{4}$ "w 44 $\frac{3}{4}$ "h 21 $\frac{1}{2}$ "d  
w/8 drawers

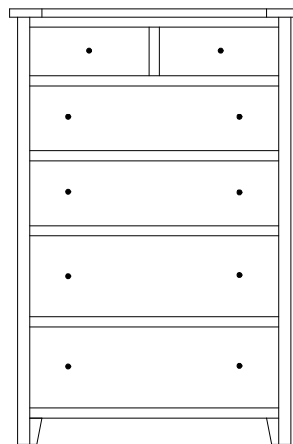

**TM-3350 Chest**  
35 $\frac{3}{4}$ "w 54"h 21 $\frac{1}{2}$ "d  
w/6 drawers

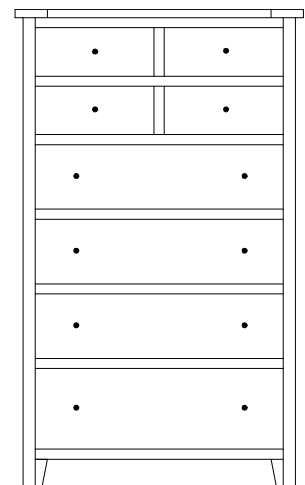

**TM-3351 Hi-Boy**  
35 $\frac{3}{4}$ "w 59 $\frac{1}{4}$ "h 21 $\frac{1}{2}$ "d  
w/8 drawers

# Timber Mill Miscellaneous

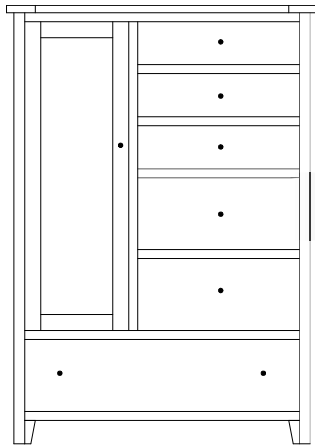

Option:  
Mirror on  
back of door

**TM-3352 Chifferobe**  
43¼"w 61¼"h 21½"d  
w/6 drawers, 1 door, 2 adj. shelves

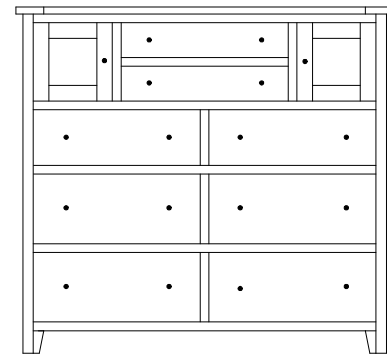

**TM-3353 His & Hers Chest**  
54¼"w 50"h 21½"d  
w/8 drawers, 2 doors

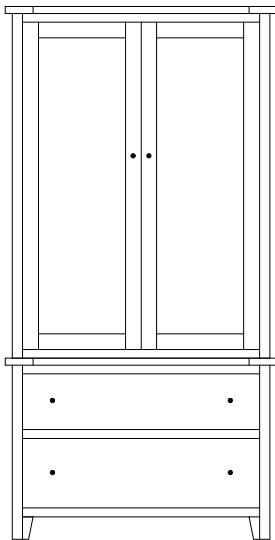

**TM-3362 Armoire**  
39"w 76½"h 21½"d  
w/2 drawers, (top drawer w/divider)  
w/2 doors, 2 adj. shelves & closet rod

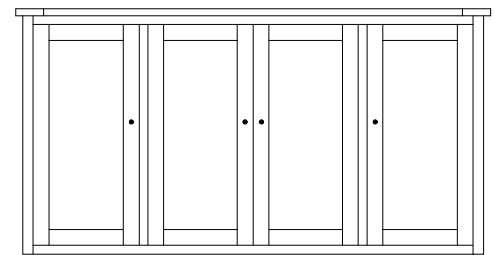

**TM-3359 Mule Chest Top**  
67¾"w 35"h 21½"d  
w/4 doors & 6 adjustable shelves

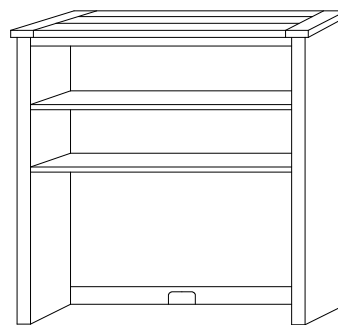

**TM-3397 Study Carrel**  
48"w 42¼"h 13"d  
w/2 adjustable shelves

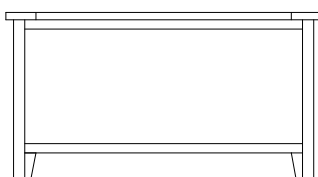

**TM-3335 Blanket Chest**  
42"w 22"h 21½"d

Available  
with aromatic  
cedar bottom

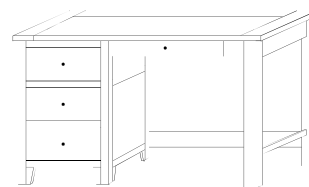

**TM-3399 Student Desk**  
48"w 29"h 23"d  
w/3 drawers  
w/1 pencil drawer

Upgrades available on student desk:

Keyboard slideout instead of pencil drawer  
File drawer instead of bottom 2 drawers

# Timber Mill Dressers



TM-3357 Dresser shown with MI-3332 Mirror

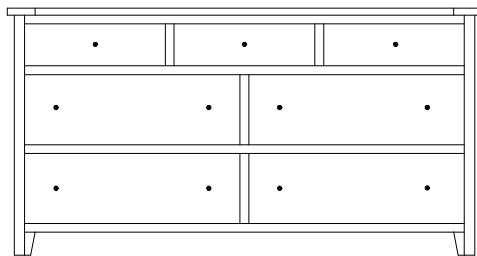

**TM-3355 Dresser**  
67¾"w 35½"h 21½"d  
w/7 drawers

Suggested Mirrors:

**MI-3331 Mirror**  
40"h 46"w

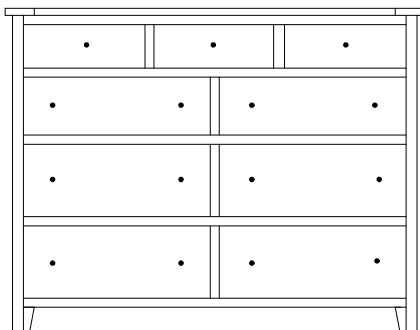

**TM-3357 Dresser**  
57¾"w 44¾"h 21½"d  
w/9 drawers

Suggested Mirrors:

**MI-3332 Mirror**  
32"h 42"w

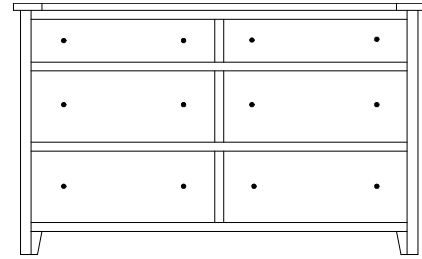

**TM-3354 Dresser**  
57¾"w 35½"h 21½"d  
w/6 drawers

Suggested Mirrors:

**MI-3330 Mirror**  
40"h 36"w

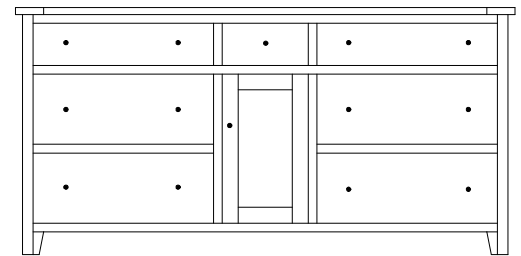

**TM-3356 Dresser**  
71¼"w 35½"h 21½"d  
w/7 drawers, 1 door  
w/1 adjustable shelf

Suggested Mirrors:

**MI-3331 Mirror**  
40"h 46"w

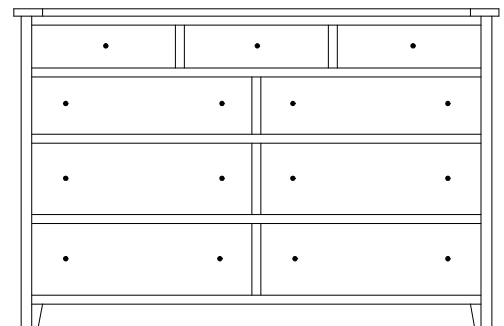

**TM-3358 Dresser**  
67¾"w 44¾"h 21½"d  
w/9 drawers

Suggested Mirrors:

**MI-3333 Mirror**  
32"h 52"w

# Timber Mill Mirrors

---



**MI-3330 Mirror**  
40"h 36"w

**MI-3331 Mirror**  
40"h 46"w

**MI-3332 Mirror**  
32"h 42"w

**MI-3333 Mirror**  
32"h 52"w

Beveled Mirror

# Timber Mill Bed Frames



Bed shown with 234-SR Storage Upgrade and Regular Footboard



Shown with Regular Footboard and 685 Storage Upgrade

## Huntington Bed Regular Footboard

Available with underbed storage options.

**HT-2125K** (King)  
83<sup>5</sup>/<sub>8</sub>"w 91"l  
HB 63<sup>1</sup>/<sub>4</sub>"h ■ FB 29"h

**HT-2125Q** (Queen)  
68"w 91"l  
HB 63<sup>1</sup>/<sub>4</sub>"h ■ FB 29"h

**HT-2125F** (Full)  
60<sup>7</sup>/<sub>8</sub>"w 86"l  
HB 63<sup>1</sup>/<sub>4</sub>"h ■ FB 29"h

**HT-2125T** (Twin)  
46"w 86"l  
HB 63<sup>1</sup>/<sub>4</sub>"h ■ FB 29"h

## Low Footboard

**HT-2126K** (King)  
83<sup>5</sup>/<sub>8</sub>"w 87<sup>3</sup>/<sub>4</sub>"l  
HB 63<sup>1</sup>/<sub>4</sub>"h ■ FB 14<sup>3</sup>/<sub>4</sub>"h

**HT-2126Q** (Queen)  
68"w 87<sup>3</sup>/<sub>4</sub>"l  
HB 63<sup>1</sup>/<sub>4</sub>"h ■ FB 14<sup>3</sup>/<sub>4</sub>"h

**HT-2126F** (Full)  
60<sup>7</sup>/<sub>8</sub>"w 82<sup>3</sup>/<sub>4</sub>"l  
HB 63<sup>1</sup>/<sub>4</sub>"h ■ FB 14<sup>3</sup>/<sub>4</sub>"h

**HT-2126T** (Twin)  
46"w 82<sup>3</sup>/<sub>4</sub>"l  
HB 63<sup>1</sup>/<sub>4</sub>"h ■ FB 14<sup>3</sup>/<sub>4</sub>"h

## Headboard Only

**HT-2127K-HB** (King)  
63<sup>1</sup>/<sub>4</sub>" high

**HT-2127Q-HB** (Queen)  
63<sup>1</sup>/<sub>4</sub>" high

**HT-2127F-HB** (Full)  
63<sup>1</sup>/<sub>4</sub>" high

**HT-2127T-HB** (Twin)  
63<sup>1</sup>/<sub>4</sub>" high

## Timber Mill Bed Regular Footboard

Available with underbed storage options.

**TM-3365-K** (King)  
79<sup>5</sup>/<sub>8</sub>"w 85<sup>1</sup>/<sub>2</sub>"l  
HB 55"h ■ FB 33<sup>1</sup>/<sub>4</sub>"h

**TM-3365-Q** (Queen)  
64"w 85<sup>1</sup>/<sub>2</sub>"l  
HB 55"h ■ FB 33<sup>1</sup>/<sub>4</sub>"h

**TM-3365-F** (Full)  
56<sup>7</sup>/<sub>8</sub>"w 80<sup>1</sup>/<sub>2</sub>"l  
HB 55"h ■ FB 33<sup>1</sup>/<sub>4</sub>"h

**TM-3365-T** (Twin)  
42"w 80<sup>1</sup>/<sub>2</sub>"l  
HB 47"h ■ FB 31"h

## Low Footboard

**TM-3366-K** (King)  
79<sup>3</sup>/<sub>4</sub>"w 85"l  
HB 55"h ■ FB 14<sup>3</sup>/<sub>4</sub>"h

**TM-3366-Q** (Queen)  
64"w 85"l  
HB 55"h ■ FB 14<sup>3</sup>/<sub>4</sub>"h

**TM-3366-F** (Full)  
56<sup>7</sup>/<sub>8</sub>"w 80"l  
HB 55"h ■ FB 14<sup>3</sup>/<sub>4</sub>"h

**TM-3366-T** (Twin)  
42"w 80"l  
HB 55"h ■ FB 14<sup>3</sup>/<sub>4</sub>"h

## Headboard Only

**TM-3367K-HB** (King)  
55" high

**TM-3367Q-HB** (Queen)  
55" high

**TM-3367F-HB** (Full)  
55" high

**TM-3367T-HB** (Twin)  
55" high

# Timber Mill Storage Rail Upgrades

## 12<sup>3</sup>/<sub>4</sub>" From Floor to Box Spring

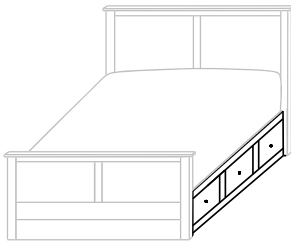

- With 3 drawers on each side
- 12<sup>3</sup>/<sub>4</sub>" from floor to Box Spring
- Inside drawer dimensions on all sizes  
9<sup>1</sup>/<sub>4</sub>"h 18<sup>7</sup>/<sub>8</sub>"w 22<sup>1</sup>/<sub>2</sub>"d

**532-SR-K** King – 6 drawers  
**532-SR-Q** Queen – 6 drawers  
**532-SR-F** Full – 6 drawers  
**532-SR-T** Twin – 3 drawers

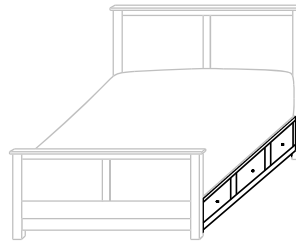

- With 3" Toe Kick
- With 3 drawers on each side
- 12<sup>3</sup>/<sub>4</sub>" from floor to Box Spring
- Inside drawer dimensions on all sizes  
6<sup>1</sup>/<sub>4</sub>"h 18<sup>7</sup>/<sub>8</sub>"w 22<sup>1</sup>/<sub>2</sub>"d

**234-SR-K** King – 6 drawers  
**234-SR-Q** Queen – 6 drawers  
**234-SR-F** Full – 6 drawers  
**234-SR-T** Twin – 3 drawers

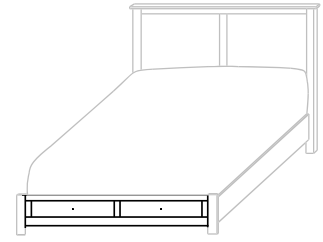

- 12<sup>3</sup>/<sub>4</sub>" from floor to Box Spring
- Inside drawer dimensions  
6<sup>1</sup>/<sub>4</sub>"h 22<sup>1</sup>/<sub>2</sub>"d  
 (King) 31"w      (Queen) 23<sup>1</sup>/<sub>4</sub>"w  
 (Full) 19<sup>5</sup>/<sub>8</sub>"w      (Twin) 29<sup>1</sup>/<sub>4</sub>"w

**685-FDS-K** King – 2 drawers  
**685-FDS-Q** Queen – 2 drawers  
**685-FDS-F** Full – 2 drawers  
**685-FDS-T** Twin – 1 drawer

## 19<sup>3</sup>/<sub>4</sub>" From Floor to Box Spring

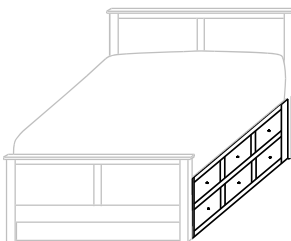

- With 6 drawers on each side
- Twin has 6 drawers on 1 side only
- 19<sup>3</sup>/<sub>4</sub>" from floor to Box Spring
- Inside drawer dimensions on all sizes  
6<sup>1</sup>/<sub>4</sub>"h 18<sup>7</sup>/<sub>8</sub>"w 22<sup>1</sup>/<sub>2</sub>"d

**654-SR-K** King – 12 drawers  
**654-SR-Q** Queen – 12 drawers  
**654-SR-F** Full – 12 drawers  
**654-SR-T** Twin – 6 drawers

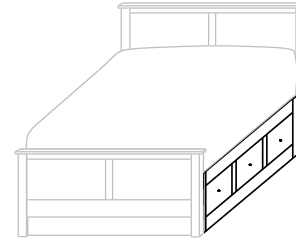

- With 3 drawers on each side
- 19<sup>3</sup>/<sub>4</sub>" from floor to Box Spring
- Inside drawer dimensions on all sizes  
10<sup>1</sup>/<sub>4</sub>"h 18<sup>7</sup>/<sub>8</sub>"w 22<sup>1</sup>/<sub>2</sub>"d

**325-SR-K** King – 6 drawers  
**325-SR-Q** Queen – 6 drawers  
**325-SR-F** Full – 6 drawers  
**325-SR-T** Twin – 3 drawers

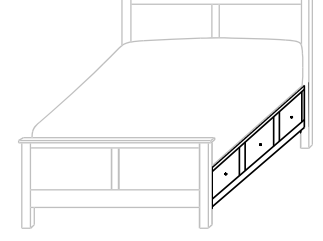

- With 7" Toe Kick
- With 3 drawers on each side
- 19<sup>3</sup>/<sub>4</sub>" from floor to Box Spring
- Inside drawer dimensions on all sizes  
9<sup>1</sup>/<sub>4</sub>"h 18<sup>7</sup>/<sub>8</sub>"w 22<sup>1</sup>/<sub>2</sub>"d

**236-SR-K** King – 6 drawers  
**236-SR-Q** Queen – 6 drawers  
**236-SR-F** Full – 6 drawers  
**236-SR-T** Twin – 3 drawers

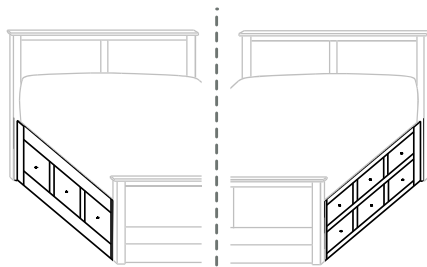

- With 3 drawers on one side and 6 drawers on other side
- 19<sup>3</sup>/<sub>4</sub>" from floor to Box Spring

**420-SR-K** King – 9 drawers  
**420-SR-Q** Queen – 9 drawers  
**420-SR-F** Full – 9 drawers  
 (Twin Not Available)

### Additional Upgrades

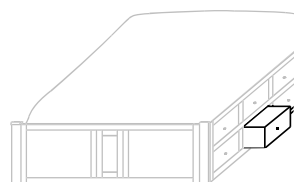

- With Step Stool Pullout in place of drawer

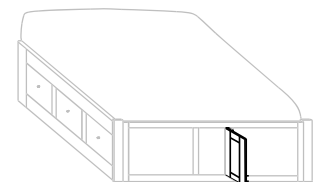

- With Door in Footboard to access area between rails





*Wilkenburg*  
Bedroom Collection

# Wilkenburg



## Wilkenburg Bedroom Collection w/Wilkenburg Bed

- WB-1738Q Queen Bed
- WB-1740 Night Stand
- WB-1750 Chest
- WB-1754 Dresser
- MI-1365 Mirror

Shown above in **Brown Maple** with **OCS-113 Michaels** and **1½" Wood Knobs**

### Standard Features:



1½" Wood Knobs



Standard with side-mount drawer slides



Stained poplar drawer boxes



Dovetailed bed slats

### Available Upgrades:

- Any hardware on our Hardware Options Sheet
- Undermount soft close slides [See Price List]



- 2-WB-1738T Twin Wilkenburg Beds
- 2-WB-1741 Night Stands
- WB-1754 Dresser
- MI-1365 Mirror

Shown in **Brown Maple** with **RNC-1160 Quench Blue** and **1½" Wood Knobs**

# Wilkenburg Night Stands



**WB-1741**  
Night Stand shown



Sliding top option available on all night stands  
(Hidden compartment w/Lock)

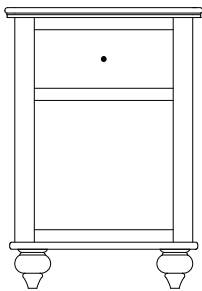

**WB-1740 Night Stand**  
20½"w 28¾"h 19"d  
w/1 drawer

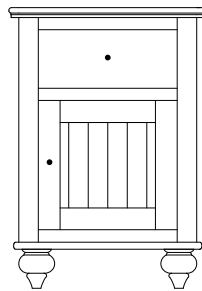

**WB-1741 Night Stand**  
20½"w 28¾"h 19"d  
w/1 drawer, 1 door

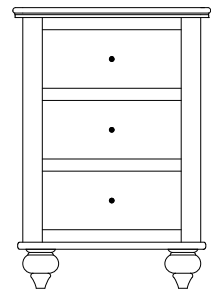

**WB-1742 Night Stand**  
20½"w 28¾"h 19"d  
w/3 drawers

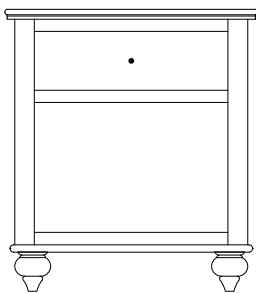

**WB-1743 Night Stand**  
25¾"w 28¾"h 19"d  
w/1 drawer

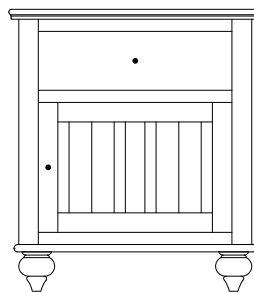

**WB-1744 Night Stand**  
25¾"w 28¾"h 19"d  
w/1 drawer, 1 door

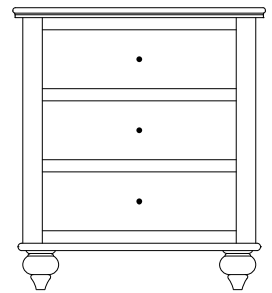

**WB-1745 Night Stand**  
25¾"w 28¾"h 19"d  
w/3 drawers

# Wilkenburg Lingeries & Chests



**WB-1750**  
Chest shown

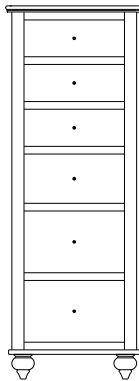

**WB-1746 Lingerie**  
22 1/4"w 60 1/2"h 21"d  
w/6 drawers

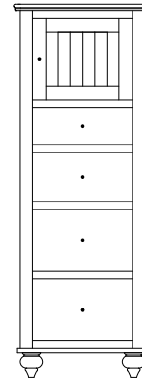

Available with  
mirror in  
door panel

**WB-1747 Lingerie**  
22 1/4"w 60 1/2"h 21"d  
w/4 drawers, 1 wood door,  
1 adjustable shelf

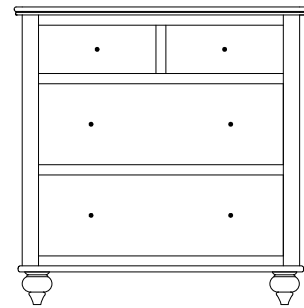

**WB-1749 Chest**  
36 1/4"w 36 3/4"h 21"d  
w/4 drawers

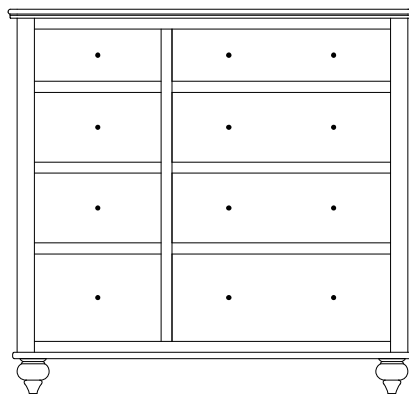

**WB-1748 Chest**  
46 3/4"w 44"h 21"d  
w/8 drawers

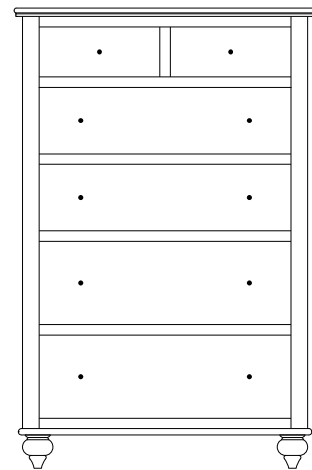

**WB-1750 Chest**  
36 1/4"w 55 1/4"h 21"d  
w/6 drawers

# Wilkenburg Miscellaneous

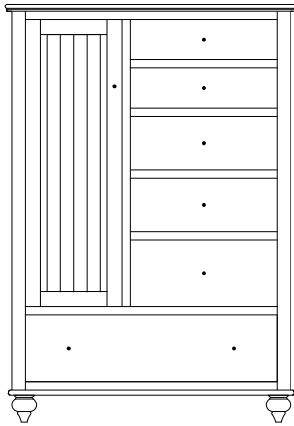

Option:  
Mirror on  
back of door

**WB-1752 Chifferobe**  
43¾"w 62½"h 21"d  
w/6 drawers, 1 door, 2 adj. shelves

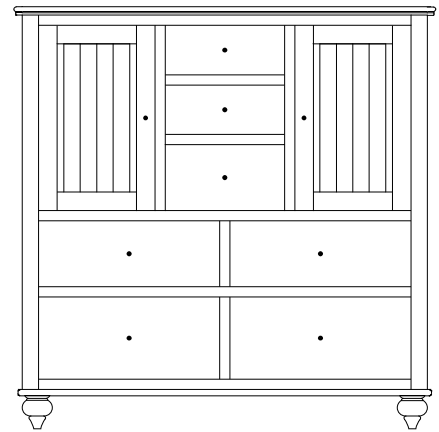

**WB-1753 His & Hers**  
51¼"w 51¼"h 21"d  
w/7 drawers, 2 doors

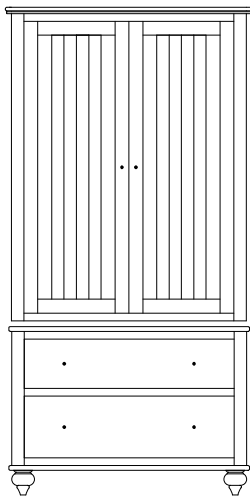

**WB-1762 Armoire**  
40"w 78"h 21"d  
w/2 drawers (top drawer w/divider)  
w/2 doors 2 adj. shelves & closet rod

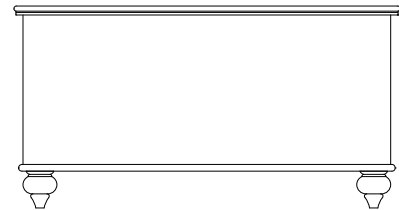

**WB-1735 Blanket Chest**  
42"w 22"h 21½"d

Available  
with aromatic  
cedar bottom

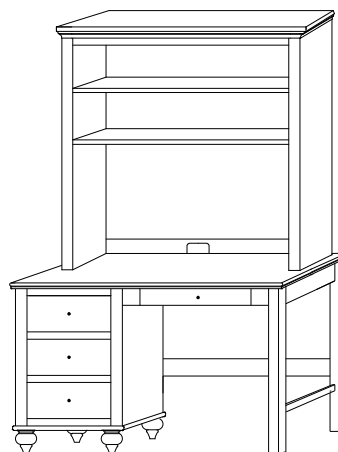

**WB-1797 Study Carrel**  
48"w 42"h 13"d  
w/2 adjustable shelves

**WB-1799 Student Desk**  
48"w 29½"h 22½"d  
w/3 drawers  
w/1 pencil drawer

Upgrades available on student desk:

Keyboard slideout instead of pencil drawer  
File drawer instead of bottom 2 drawers

# Wilkenburg Dressers



WB-1754 Dresser shown with MI-1365 Mirror

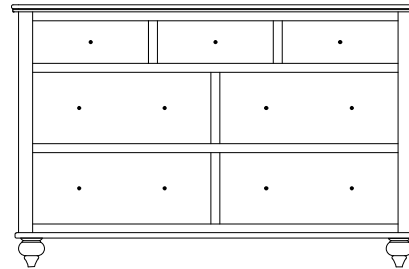

**WB-1754 Dresser**  
57 1/4"w 36 3/4"h 21"d  
w/7 drawers

Suggested Mirrors:

**MI-1365 Mirror**  
40"h 36"w

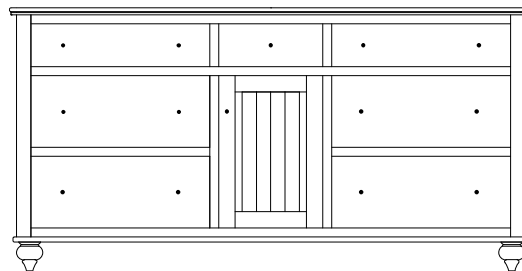

**WB-1756 Dresser**  
73"w 36 3/4"h 21"d  
w/7 drawers, 1 door  
w/1 adjustable shelf

Suggested Mirrors:

**MI-1366 Mirror**  
40"h 46"w

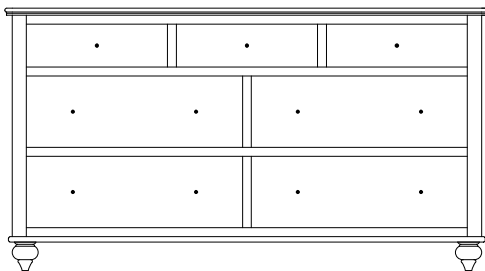

**WB-1755 Dresser**  
67 3/4"w 36 3/4"h 21"d  
w/7 drawers

Suggested Mirrors:

**MI-1366 Mirror**  
40"h 46"w

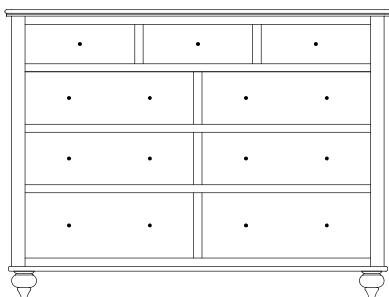

**WB-1757 Tall Dresser**  
57 1/4"w 44"h 21"d  
w/9 drawers

Suggested Mirrors:

**MI-1367 Mirror**  
32"h 42"w

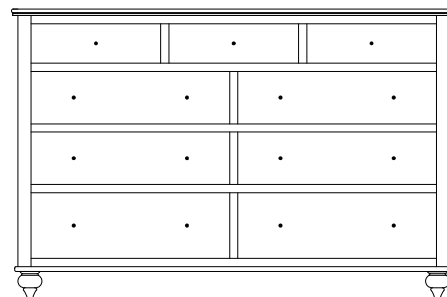

**WB-1758 Tall Dresser**  
67 3/4"w 44"h 21"d  
w/9 drawers

Suggested Mirrors:

**MI-1368 Mirror**  
32"h 52"w



**MI-1365 Mirror**  
40"high 36"wide

**MI-1366 Mirror**  
40"high 46"wide

**MI-1367 Mirror**  
32"high 42"wide

**MI-1368 Mirror**  
32"high 52"wide

Beveled Mirror

# Wilkenburg Bed Frames



shown with Low Footboard

## Wilkenburg Bed

### Regular Footboard

Available  
with underbed  
storage options.

**WB-1736-K (King)**  
81 5/8"w 86 1/2"l  
HB 53"h ■ FB 30"h

**WB-1736-Q (Queen)**  
66"w 86 1/2"l  
HB 53"h ■ FB 30"h

**WB-1736-F (Full)**  
58 7/8"w 81 1/2"l  
HB 53"h ■ FB 30"h

**WB-1736-T (Twin)**  
44"w 81 1/2"l  
HB 53"h ■ FB 30"h

### Low Footboard

**WB-1738-K (King)**  
81 5/8"w 85 1/2"l  
HB 53"h ■ FB 14 3/4"h

**WB-1738-Q (Queen)**  
66"w 85 1/2"l  
HB 53"h ■ FB 14 3/4"h

**WB-1738-F (Full)**  
58 7/8"w 80 1/2"l  
HB 53"h ■ FB 14 3/4"h

**WB-1738-T (Twin)**  
44"w 80 1/2"l  
HB 53"h ■ FB 14 3/4"h

### Headboard Only

**WB-1741-HB-K (King)**  
53" high

**WB-1741-HB-Q (Queen)**  
53" high

**WB-1741-HB-F (Full)**  
53" high

**WB-1741-HB-T (Twin)**  
53" high

# Wilkenburg Storage Rail Upgrades

## 12<sup>3</sup>/<sub>4</sub>" From Floor to Box Spring

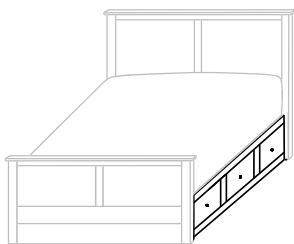

- With 3 drawers on each side
- 12<sup>3</sup>/<sub>4</sub>" from floor to Box Spring
- Inside drawer dimensions on all sizes  
9<sup>1</sup>/<sub>4</sub>"h 18<sup>7</sup>/<sub>8</sub>"w 22<sup>1</sup>/<sub>2</sub>"d

**532-SR-K** King – 6 drawers  
**532-SR-Q** Queen – 6 drawers  
**532-SR-F** Full – 6 drawers  
**532-SR-T** Twin – 3 drawers

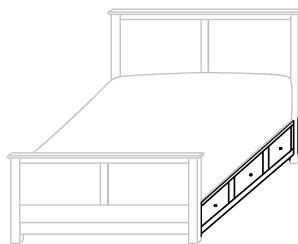

- With 3" Toe Kick
- With 3 drawers on each side
- 12<sup>3</sup>/<sub>4</sub>" from floor to Box Spring
- Inside drawer dimensions on all sizes  
6<sup>1</sup>/<sub>4</sub>"h 18<sup>7</sup>/<sub>8</sub>"w 22<sup>1</sup>/<sub>2</sub>"d

**234-SR-K** King – 6 drawers  
**234-SR-Q** Queen – 6 drawers  
**234-SR-F** Full – 6 drawers  
**234-SR-T** Twin – 3 drawers

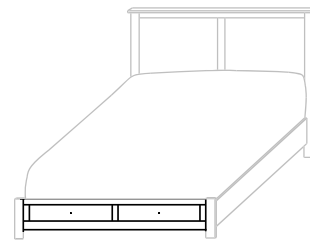

- 12<sup>3</sup>/<sub>4</sub>" from floor to Box Spring
- Inside drawer dimensions  
6<sup>1</sup>/<sub>4</sub>"h 22<sup>1</sup>/<sub>2</sub>"d  
 (King) 31"w      (Queen) 23<sup>1</sup>/<sub>4</sub>"w  
 (Full) 19<sup>5</sup>/<sub>8</sub>"w      (Twin) 29<sup>1</sup>/<sub>4</sub>"w

**685-FDS-K** King – 2 drawers  
**685-FDS-Q** Queen – 2 drawers  
**685-FDS-F** Full – 2 drawers  
**685-FDS-T** Twin – 1 drawer

## 19<sup>3</sup>/<sub>4</sub>" From Floor to Box Spring

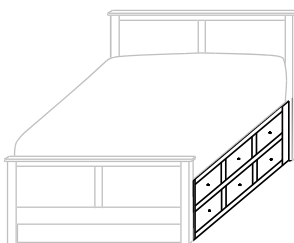

- With 6 drawers on each side
- Twin has 6 drawers on 1 side only
- 19<sup>3</sup>/<sub>4</sub>" from floor to Box Spring
- Inside drawer dimensions on all sizes  
6<sup>1</sup>/<sub>4</sub>"h 18<sup>7</sup>/<sub>8</sub>"w 22<sup>1</sup>/<sub>2</sub>"d

**654-SR-K** King – 12 drawers  
**654-SR-Q** Queen – 12 drawers  
**654-SR-F** Full – 12 drawers  
**654-SR-T** Twin – 6 drawers

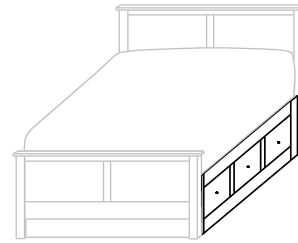

- With 3 drawers on each side
- 19<sup>3</sup>/<sub>4</sub>" from floor to Box Spring
- Inside drawer dimensions on all sizes  
10<sup>1</sup>/<sub>4</sub>"h 18<sup>7</sup>/<sub>8</sub>"w 22<sup>1</sup>/<sub>2</sub>"d

**325-SR-K** King – 6 drawers  
**325-SR-Q** Queen – 6 drawers  
**325-SR-F** Full – 6 drawers  
**325-SR-T** Twin – 3 drawers

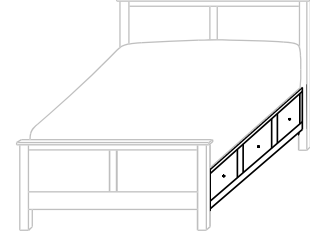

- With 7" Toe Kick
- With 3 drawers on each side
- 19<sup>3</sup>/<sub>4</sub>" from floor to Box Spring
- Inside drawer dimensions on all sizes  
9<sup>1</sup>/<sub>4</sub>"h 18<sup>7</sup>/<sub>8</sub>"w 22<sup>1</sup>/<sub>2</sub>"d

**236-SR-K** King – 6 drawers  
**236-SR-Q** Queen – 6 drawers  
**236-SR-F** Full – 6 drawers  
**236-SR-T** Twin – 3 drawers

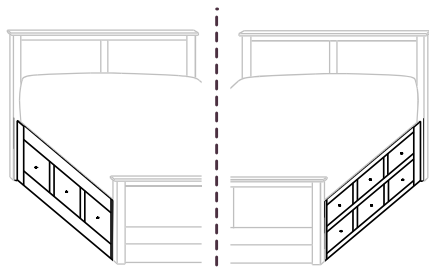

- With 3 drawers on one side and 6 drawers on other side
- 19<sup>3</sup>/<sub>4</sub>" from floor to Box Spring

**420-SR-K** King – 9 drawers  
**420-SR-Q** Queen – 9 drawers  
**420-SR-F** Full – 9 drawers  
 (Twin Not Available)

### Additional Upgrades

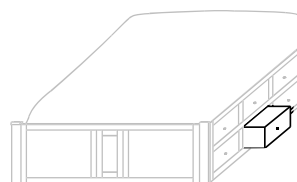

- With Step Stool Pullout in place of drawer

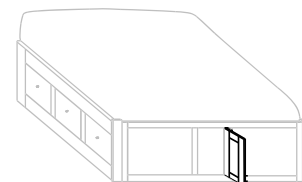

- With Door in Footboard to access area between rails

# Bed Details

## Dimensions for all Beds with Regular Rails

- 9 $\frac{7}{8}$ " from floor to top of slats
- 8" from floor to bottom of rails
- 6" high rails



## Storage Rail System

- Available on all beds or sold separate
- 2 height options

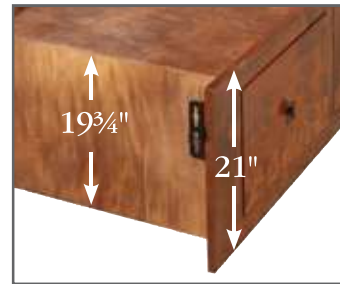

## Footboard Drawer System

- Available on all beds or sold separate



12 $\frac{3}{4}$ " from floor to Box Spring or Mattress

# Storage Rail Upgrades

## 12<sup>3</sup>/<sub>4</sub>" From Floor to Box Spring

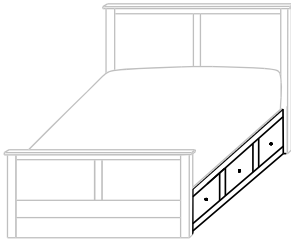

- With 3 drawers on each side
- 12<sup>3</sup>/<sub>4</sub>" from floor to Box Spring
- Inside drawer dimensions on all sizes  
9<sup>1</sup>/<sub>4</sub>"h 18<sup>7</sup>/<sub>8</sub>"w 22<sup>1</sup>/<sub>2</sub>"d

**532-SR-K** King – 6 drawers  
**532-SR-Q** Queen – 6 drawers  
**532-SR-F** Full – 6 drawers  
**532-SR-T** Twin – 3 drawers

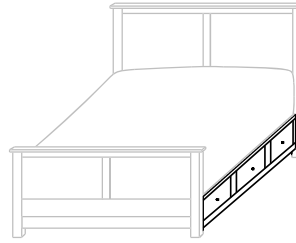

- With 3" Toe Kick
- With 3 drawers on each side
- 12<sup>3</sup>/<sub>4</sub>" from floor to Box Spring
- Inside drawer dimensions on all sizes  
6<sup>1</sup>/<sub>4</sub>"h 18<sup>7</sup>/<sub>8</sub>"w 22<sup>1</sup>/<sub>2</sub>"d

**234-SR-K** King – 6 drawers  
**234-SR-Q** Queen – 6 drawers  
**234-SR-F** Full – 6 drawers  
**234-SR-T** Twin – 3 drawers

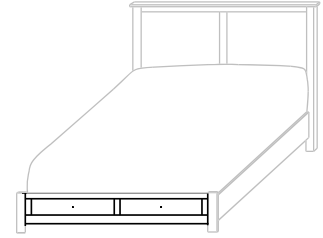

- 12<sup>3</sup>/<sub>4</sub>" from floor to Box Spring
- Inside drawer dimensions  
6<sup>1</sup>/<sub>4</sub>"h 22<sup>1</sup>/<sub>2</sub>"d  
(King) 31"w (Queen) 23<sup>1</sup>/<sub>4</sub>"w  
(Full) 19<sup>5</sup>/<sub>8</sub>"w (Twin) 29<sup>1</sup>/<sub>4</sub>"w

**685-FDS-K** King – 2 drawers  
**685-FDS-Q** Queen – 2 drawers  
**685-FDS-F** Full – 2 drawers  
**685-FDS-T** Twin – 1 drawer

## 19<sup>3</sup>/<sub>4</sub>" From Floor to Box Spring

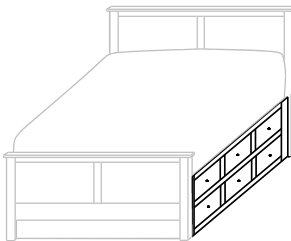

- With 6 drawers on each side
- Twin has 6 drawers on 1 side only
- 19<sup>3</sup>/<sub>4</sub>" from floor to Box Spring
- Inside drawer dimensions on all sizes  
6<sup>1</sup>/<sub>4</sub>"h 18<sup>7</sup>/<sub>8</sub>"w 22<sup>1</sup>/<sub>2</sub>"d

**654-SR-K** King – 12 drawers  
**654-SR-Q** Queen – 12 drawers  
**654-SR-F** Full – 12 drawers  
**654-SR-T** Twin – 6 drawers

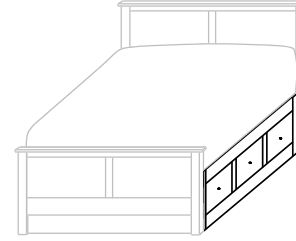

- With 3 drawers on each side
- 19<sup>3</sup>/<sub>4</sub>" from floor to Box Spring
- Inside drawer dimensions on all sizes  
10<sup>1</sup>/<sub>4</sub>"h 18<sup>7</sup>/<sub>8</sub>"w 22<sup>1</sup>/<sub>2</sub>"d

**325-SR-K** King – 6 drawers  
**325-SR-Q** Queen – 6 drawers  
**325-SR-F** Full – 6 drawers  
**325-SR-T** Twin – 3 drawers

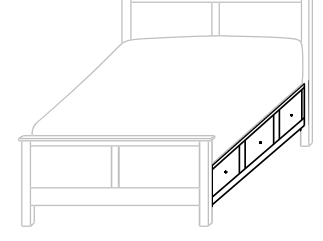

- With 7" Toe Kick
- With 3 drawers on each side
- 19<sup>3</sup>/<sub>4</sub>" from floor to Box Spring
- Inside drawer dimensions on all sizes  
9<sup>1</sup>/<sub>4</sub>"h 18<sup>7</sup>/<sub>8</sub>"w 22<sup>1</sup>/<sub>2</sub>"d

**236-SR-K** King – 6 drawers  
**236-SR-Q** Queen – 6 drawers  
**236-SR-F** Full – 6 drawers  
**236-SR-T** Twin – 3 drawers

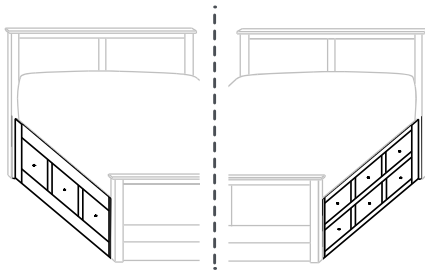

- With 3 drawers on one side and 6 drawers on other side
- 19<sup>3</sup>/<sub>4</sub>" from floor to Box Spring

**420-SR-K** King – 9 drawers  
**420-SR-Q** Queen – 9 drawers  
**420-SR-F** Full – 9 drawers  
 (Twin Not Available)

### Additional Upgrades

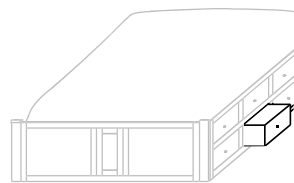

- With Step Stool Pullout in place of drawer

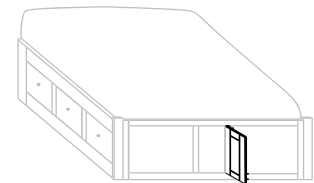

- With Door in Footboard to access area between rails



Shown with Regular Footboard



Shown with Regular Footboard

## Allentown Bed

Available  
with underbed  
storage options.

### Regular Footboard

**AL-4017-K** (King)  
84 $\frac{5}{8}$ "w 87 $\frac{3}{4}$ "l  
HB 48"h ■ FB 18"h

**AL-4017-Q** (Queen)  
69"w 87 $\frac{3}{4}$ "l  
HB 48"h ■ FB 18"h

**AL-4017-F** (Full)  
61 $\frac{7}{8}$ "w 82 $\frac{3}{4}$ "l  
HB 48"h ■ FB 18"h

**AL-4017-T** (Twin)  
47"w 82 $\frac{3}{4}$ "l  
HB 48"h ■ FB 18"h

### Low Footboard

**Al-4025-K** (King)  
84 $\frac{5}{8}$ "w 87 $\frac{3}{4}$ "l  
HB 48"h ■ FB 14 $\frac{3}{4}$ "h

**Al-4025-Q** (Queen)  
69"w 87 $\frac{3}{4}$ "l  
HB 48"h ■ FB 14 $\frac{3}{4}$ "h

**Al-4025-F** (Full)  
61 $\frac{7}{8}$ "w 82 $\frac{3}{4}$ "l  
HB 48"h ■ FB 14 $\frac{3}{4}$ "h

**Al-4025-T** (Twin)  
47"w 82 $\frac{3}{4}$ "l  
HB 48"h ■ FB 14 $\frac{3}{4}$ "h

### Headboard Only

**AL-4033K-HB** (King)  
48" high

**AL-4033Q-HB** (Queen)  
48" high

**AL-4033F-HB** (Full)  
48" high

**AL-4033T-HB** (Twin)  
48" high

## Antique Mission Bed

Available  
with underbed  
storage options.

### Regular Footboard

**AM-2615-K** (King)  
82 $\frac{5}{8}$ "w 88"l  
HB 52 $\frac{3}{4}$ "h ■ FB 27 $\frac{1}{2}$ "h

**AM-2615-Q** (Queen)  
67"w 88"l  
HB 52 $\frac{3}{4}$ "h ■ FB 27 $\frac{1}{2}$ "h

**AM-2615-F** (Full)  
59 $\frac{7}{8}$ "w 83"l  
HB 52 $\frac{3}{4}$ "h ■ FB 27 $\frac{1}{2}$ "h

**AM-2615-T** (Twin)  
45"w 83"l  
HB 52 $\frac{3}{4}$ "h ■ FB 27 $\frac{1}{2}$ "h

### Low Footboard

**AM-2616-K** (King)  
82 $\frac{5}{8}$ "w 86 $\frac{1}{4}$ "l  
HB 52 $\frac{3}{4}$ "h ■ FB 14 $\frac{3}{4}$ "h

**AM-2616-Q** (Queen)  
67"w 86 $\frac{1}{4}$ "l  
HB 52 $\frac{3}{4}$ "h ■ FB 14 $\frac{3}{4}$ "h

**AM-2616-F** (Full)  
59 $\frac{7}{8}$ "w 81 $\frac{1}{4}$ "l  
HB 52 $\frac{3}{4}$ "h ■ FB 14 $\frac{3}{4}$ "h

**AM-2616-T** (Twin)  
45"w 81 $\frac{1}{4}$ "l  
HB 52 $\frac{3}{4}$ "h ■ FB 14 $\frac{3}{4}$ "h

### Headboard Only

**AM-2617K-HB** (King)  
52 $\frac{3}{4}$ " high

**AM-2617Q-HB** (Queen)  
52 $\frac{3}{4}$ " high

**AM-2617F-HB** (Full)  
52 $\frac{3}{4}$ " high

**AM-2617T-HB** (Twin)  
52 $\frac{3}{4}$ " high



Shown with Low Footboard



Shown with Regular Footboard

## Arch Spindle Bed

Available with underbed storage options.

### Regular Footboard

**AS-2625-K** (King)  
79<sup>5</sup>/<sub>8</sub>"w 84<sup>1</sup>/<sub>2</sub>"l  
HB 48"h ■ FB 30"h

**AS-2625-Q** (Queen)  
64"w 84<sup>1</sup>/<sub>2</sub>"l  
HB 48"h ■ FB 30"h

**AS-2625-F** (Full)  
56<sup>7</sup>/<sub>8</sub>"w 79<sup>1</sup>/<sub>2</sub>"l  
HB 48"h ■ FB 30"h

**AS-2625-T** (Twin)  
42"w 79<sup>1</sup>/<sub>2</sub>"l  
HB 48"h ■ FB 30"h

### Low Footboard

**AS-2626-K** (King)  
79<sup>5</sup>/<sub>8</sub>"w 84<sup>1</sup>/<sub>2</sub>"l  
HB 48"h ■ FB 14<sup>3</sup>/<sub>4</sub>"h

**AS-2626-Q** (Queen)  
64"w 84<sup>1</sup>/<sub>2</sub>"l  
HB 48"h ■ FB 14<sup>3</sup>/<sub>4</sub>"h

**AS-2626-F** (Full)  
56<sup>7</sup>/<sub>8</sub>"w 79<sup>1</sup>/<sub>2</sub>"l  
HB 48"h ■ FB 14<sup>3</sup>/<sub>4</sub>"h

**AS-2626-T** (Twin)  
42"w 79<sup>1</sup>/<sub>2</sub>"l  
HB 48"h ■ FB 14<sup>3</sup>/<sub>4</sub>"h

### Headboard Only

**AS-2627K-HB** (King)  
48" high

**AS-2627Q-HB** (Queen)  
48" high

**AS-2627F-HB** (Full)  
48" high

**AS-2627T-HB** (Twin)  
48" high

## Avenue Sleigh Bed

Available with underbed storage options.

### Regular Footboard

**AV-1101-K** (King)  
79<sup>3</sup>/<sub>8</sub>"w 93"l  
HB 58"h ■ FB 30"h

**AV-1101-Q** (Queen)  
64"w 93"l  
HB 58"h ■ FB 30"h

**AV-1101-F** (Full)  
56<sup>7</sup>/<sub>8</sub>"w 88"l  
HB 58"h ■ FB 30"h

**AV-1101-T** (Twin)  
42"w 88"l  
HB 58"h ■ FB 30"h

### Low Footboard

**AV-1102-K** (King)  
79<sup>3</sup>/<sub>8</sub>"w 88<sup>3</sup>/<sub>4</sub>"l  
HB 58"h ■ FB 14<sup>3</sup>/<sub>4</sub>"h

**AV-1102-Q** (Queen)  
64"w 88<sup>3</sup>/<sub>4</sub>"l  
HB 58"h ■ FB 14<sup>3</sup>/<sub>4</sub>"h

**AV-1102-F** (Full)  
56<sup>7</sup>/<sub>8</sub>"w 83<sup>3</sup>/<sub>4</sub>"l  
HB 58"h ■ FB 14<sup>3</sup>/<sub>4</sub>"h

**AV-1102-T** (Twin)  
42"w 83<sup>3</sup>/<sub>4</sub>"l  
HB 58"h ■ FB 14<sup>3</sup>/<sub>4</sub>"h

### Headboard Only

**AV-1103K-HB** (King)  
58" high

**AV-1103Q-HB** (Queen)  
58" high

**AV-1103F-HB** (Full)  
58" high

**AV-1103T-HB** (Twin)  
58" high



Shown with Regular Footboard



Shown with Low Footboard

## Barrington Bed w/Fabric Panels

Available with underbed storage options.

### Regular Footboard

**BR-1417-K** (King)  
78 $\frac{5}{8}$ "w 84 $\frac{1}{2}$ "l  
HB 54"h ■ FB 30"h

**BR-1417-Q** (Queen)  
63 $\frac{1}{8}$ "w 84 $\frac{1}{2}$ "l  
HB 54"h ■ FB 30"h

**BR-1417-F** (Full)  
55 $\frac{7}{8}$ "w 79 $\frac{1}{2}$ "l  
HB 54"h ■ FB 30"h

**BR-1417-T** (Twin)  
41"w 79 $\frac{1}{2}$ "l  
HB 54"h ■ FB 30"h

### Low Footboard

**BR-1425-K** (King)  
78 $\frac{5}{8}$ "w 84 $\frac{1}{2}$ "l  
HB 54"h ■ FB 14 $\frac{3}{4}$ "h

**BR-1425-Q** (Queen)  
63 $\frac{1}{8}$ "w 84 $\frac{1}{2}$ "l  
HB 54"h ■ FB 14 $\frac{3}{4}$ "h

**BR-1425-F** (Full)  
55 $\frac{7}{8}$ "w 79 $\frac{1}{2}$ "l  
HB 54"h ■ FB 14 $\frac{3}{4}$ "h

**BR-1425-T** (Twin)  
41"w 79 $\frac{1}{2}$ "l  
HB 54"h ■ FB 14 $\frac{3}{4}$ "h

### Headboard Only

**BR-1433K-HB** (King)  
54" high

**BR-1433Q-HB** (Queen)  
54" high

**BR-1433F-HB** (Full)  
54" high

**BR-1433T-HB** (Twin)  
54" high

## Barrington Bed w/Wood Panels

Available with underbed storage options.

### Regular Footboard

**BR-1414-K** (King)  
78 $\frac{5}{8}$ "w 84 $\frac{1}{2}$ "l  
HB 54"h ■ FB 30"h

**BR-1414-Q** (Queen)  
63 $\frac{1}{8}$ "w 84 $\frac{1}{2}$ "l  
HB 54"h ■ FB 30"h

**BR-1414-F** (Full)  
55 $\frac{7}{8}$ "w 79 $\frac{1}{2}$ "l  
HB 54"h ■ FB 30"h

**BR-1414-T** (Twin)  
41"w 79 $\frac{1}{2}$ "l  
HB 54"h ■ FB 30"h

### Low Footboard

**BR-1422-K** (King)  
78 $\frac{5}{8}$ "w 84 $\frac{1}{2}$ "l  
HB 54"h ■ FB 14 $\frac{3}{4}$ "h

**BR-1422-Q** (Queen)  
63 $\frac{1}{8}$ "w 84 $\frac{1}{2}$ "l  
HB 54"h ■ FB 14 $\frac{3}{4}$ "h

**BR-1422-F** (Full)  
55 $\frac{7}{8}$ "w 79 $\frac{1}{2}$ "l  
HB 54"h ■ FB 14 $\frac{3}{4}$ "h

**BR-1422-T** (Twin)  
41"w 79 $\frac{1}{2}$ "l  
HB 54"h ■ FB 14 $\frac{3}{4}$ "h

### Headboard Only

**BR-1430K-HB** (King)  
54" high

**BR-1430Q-HB** (Queen)  
54" high

**BR-1430F-HB** (Full)  
54" high

**BR-1430T-HB** (Twin)  
54" high



Shown with Regular Footboard



Shown with Low Footboard

## Bevel Panel Sleigh Bed

Available with underbed storage options.

### Regular Footboard

**BP-2675-K** (King)  
81½"w 91"l  
HB 54"h ■ FB 27"h

**BP-2675-Q** (Queen)  
63"w 91"l  
HB 54"h ■ FB 27"h

**BP-2675-F** (Full)  
59"w 86"l  
HB 54"h ■ FB 27"h

**BP-2675-T** (Twin)  
41"w 86"l  
HB 54"h ■ FB 27"h

### Low Footboard

**BP-2676-K** (King)  
81½"w 87¾"l  
HB 54"h ■ FB 14¾"h

**BP-2676-Q** (Queen)  
63"w 87¾"l  
HB 54"h ■ FB 14¾"h

**BP-2676-F** (Full)  
59"w 82¾"l  
HB 54"h ■ FB 14¾"h

**BP-2676-T** (Twin)  
41"w 82¾"l  
HB 54"h ■ FB 14¾"h

### Headboard Only

**BP-2677K-HB** (King)  
54" high

**BP-2677Q-HB** (Queen)  
54" high

**BP-2677F-HB** (Full)  
54" high

**BP-2677T-HB** (Twin)  
54" high

## Bookcase Bed - CA

Available with underbed storage options.

### Headboard depth 10"

**CA-1110-K** (King)  
82"w 92¾"l  
HB 50"h ■ FB 14¾"h

**CA-1110-Q** (Queen)  
66½"w 92¾"l  
HB 50"h ■ FB 14¾"h

**CA-1110-F** (Full)  
59¾"w 87¾"l  
HB 50"h ■ FB 14¾"h

**CA-1110-T** (Twin)  
44½"w 87¾"l  
HB 50"h ■ FB 14¾"h

### Headboard Only

**CA-1112K-HB** (King)  
50" high

**CA-1112Q-HB** (Queen)  
50" high

**CA-1112F-HB** (Full)  
50" high

**CA-1112T-HB** (Twin)  
50" high



532-SR  
Storage  
Upgrade ↗

Shown with Low Footboard



Shown with Regular Footboard

## Bookcase Bed - SO

Available with underbed storage options.

### Headboard depth 11<sup>3</sup>/<sub>4</sub>"

**SO-1074-K** (King)

81<sup>7</sup>/<sub>8</sub>"w 93<sup>3</sup>/<sub>4</sub>"l

HB 49<sup>3</sup>/<sub>4</sub>"h ■ FB 14<sup>3</sup>/<sub>4</sub>"h

**SO-1074-Q** (Queen)

66"w 93<sup>3</sup>/<sub>4</sub>"l

HB 49<sup>3</sup>/<sub>4</sub>"h ■ FB 14<sup>3</sup>/<sub>4</sub>"h

**SO-1074-F** (Full)

58<sup>7</sup>/<sub>8</sub>"w 88<sup>3</sup>/<sub>4</sub>"l

HB 49<sup>3</sup>/<sub>4</sub>"h ■ FB 14<sup>3</sup>/<sub>4</sub>"h

**SO-1074-T** (Twin)

43<sup>7</sup>/<sub>8</sub>"w 88<sup>3</sup>/<sub>4</sub>"l

HB 49<sup>3</sup>/<sub>4</sub>"h ■ FB 14<sup>3</sup>/<sub>4</sub>"h

### Headboard Only

**SO-1076K-HB** (King)

49<sup>3</sup>/<sub>4</sub>" high

**SO-1076Q-HB** (Queen)

49<sup>3</sup>/<sub>4</sub>" high

**SO-1076F-HB** (Full)

49<sup>3</sup>/<sub>4</sub>" high

**SO-1076T-HB** (Twin)

49<sup>3</sup>/<sub>4</sub>" high

## Brookstone Bed

Available with underbed storage options.

### Regular Footboard

**BP-2865-K** (King)

82<sup>7</sup>/<sub>8</sub>"w 89"l

HB 55<sup>1</sup>/<sub>4</sub>"h ■ FB 34" h

**BP-2865-Q** (Queen)

67" w 89" l

HB 55<sup>1</sup>/<sub>4</sub>"h ■ FB 34" h

**BP-2865-F** (Full)

59<sup>7</sup>/<sub>8</sub>"w 84"l

HB 55<sup>1</sup>/<sub>4</sub>"h ■ FB 34" h

**BP-2865-T** (Twin)

45" w 84" l

HB 55<sup>1</sup>/<sub>4</sub>"h ■ FB 34" h

### Low Footboard

**BK-2866-K** (King)

82<sup>5</sup>/<sub>8</sub>"w 87<sup>1</sup>/<sub>4</sub>"l

HB 55<sup>1</sup>/<sub>4</sub>"h ■ FB 14<sup>3</sup>/<sub>4</sub>"h

**BK-2866-Q** (Queen)

67" w 87<sup>1</sup>/<sub>4</sub>" l

HB 55<sup>1</sup>/<sub>4</sub>"h ■ FB 14<sup>3</sup>/<sub>4</sub>"h

**BK-2866-F** (Full)

59<sup>7</sup>/<sub>8</sub>"w 82<sup>1</sup>/<sub>4</sub>"l

HB 55<sup>1</sup>/<sub>4</sub>"h ■ FB 14<sup>3</sup>/<sub>4</sub>"h

**BK-2866-T** (Twin)

45" w 82<sup>1</sup>/<sub>4</sub>" l

HB 55<sup>1</sup>/<sub>4</sub>"h ■ FB 14<sup>3</sup>/<sub>4</sub>"h

### Headboard Only

**BK-2867K-HB** (King)

55<sup>1</sup>/<sub>4</sub>" high

**BK-2867Q-HB** (Queen)

55<sup>1</sup>/<sub>4</sub>" high

**BK-2867F-HB** (Full)

55<sup>1</sup>/<sub>4</sub>" high

**BK-2867T-HB** (Twin)

55<sup>1</sup>/<sub>4</sub>" high



Shown with Regular Footboard



532-SR  
Storage  
Upgrade

Shown with Regular Footboard

## Cabin Creek Bed Regular Footboard

Available  
with underbed  
storage options.

**CA-564-K** (King)  
82 $\frac{1}{8}$ "w 89 $\frac{1}{2}$ "l  
HB 49 $\frac{1}{4}$ "h ■ FB 21 $\frac{1}{4}$ "h

**CA-564-Q** (Queen)  
66 $\frac{5}{8}$ "w 89 $\frac{1}{2}$ "l  
HB 49 $\frac{1}{4}$ "h ■ FB 21 $\frac{1}{4}$ "h

**CA-564-F** (Full)  
59 $\frac{3}{8}$ "w 84 $\frac{1}{2}$ "l  
HB 49 $\frac{1}{4}$ "h ■ FB 21 $\frac{1}{4}$ "h

**CA-564-T** (Twin)  
44 $\frac{1}{2}$ "w 84 $\frac{1}{2}$ "l  
HB 49 $\frac{1}{4}$ "h ■ FB 21 $\frac{1}{4}$ "h

### Headboard Only

**CA-568K-HB** (King)  
49 $\frac{1}{4}$ " high

**CA-568Q-HB** (Queen)  
49 $\frac{1}{4}$ " high

**CA-568F-HB** (Full)  
49 $\frac{1}{4}$ " high

**CA-568T-HB** (Twin)  
49 $\frac{1}{4}$ " high

## Cabin Creek Bed w/Canopy Regular Footboard

Available  
with underbed  
storage options.

**CA-566-K** (King)  
82 $\frac{1}{8}$ "w 89 $\frac{1}{2}$ "l  
HB 49 $\frac{1}{4}$ "h ■ FB 21 $\frac{1}{4}$ "h

**CA-566-Q** (Queen)  
66 $\frac{5}{8}$ "w 89 $\frac{1}{2}$ "l  
HB 49 $\frac{1}{4}$ "h ■ FB 21 $\frac{1}{4}$ "h

**CA-566-F** (Full)  
59 $\frac{3}{8}$ "w 84 $\frac{1}{2}$ "l  
HB 49 $\frac{1}{4}$ "h ■ FB 21 $\frac{1}{4}$ "h

**CA-566-T** (Twin)  
44 $\frac{1}{2}$ "w 84 $\frac{1}{2}$ "l  
HB 49 $\frac{1}{4}$ "h ■ FB 21 $\frac{1}{4}$ "h



Shown with Regular Footboard & Leather Panels



Shown with Regular Footboard

## Canyon Creek Bed

Available with underbed storage options.

### Regular Footboard

**CC-2565-K (King)**  
82 $\frac{5}{8}$ "w 88"l  
HB 58"h ■ FB 27"h

**CC-2565-Q (Queen)**  
67"w 88"l  
HB 58"h ■ FB 27"h

**CC-2565-F (Full)**  
59 $\frac{7}{8}$ "w 83"l  
HB 58"h ■ FB 27"h

**CC-2565-T (Twin)**  
45"w 83"l  
HB 58"h ■ FB 27"h

### Low Footboard

**CC-2566-K (King)**  
82 $\frac{5}{8}$ "w 86 $\frac{1}{4}$ "l  
HB 58"h ■ FB 14 $\frac{3}{4}$ "h

**CC-2566-Q (Queen)**  
67"w 86 $\frac{1}{4}$ "l  
HB 58"h ■ FB 14 $\frac{3}{4}$ "h

**CC-2566-F (Full)**  
59 $\frac{7}{8}$ "w 81 $\frac{1}{4}$ "l  
HB 58"h ■ FB 14 $\frac{3}{4}$ "h

**CC-2566-T (Twin)**  
45"w 81 $\frac{1}{4}$ "l  
HB 58"h ■ FB 14 $\frac{3}{4}$ "h

### Headboard Only

**CC-2567K-HB (King)**  
58" high

**CC-2567Q-HB (Queen)**  
58" high

**CC-2567F-HB (Full)**  
58" high

**CC-2567T-HB (Twin)**  
58" high

## Claremont Panel Bed

Available with underbed storage options.

### Regular Footboard

**CM-2002-K (King)**  
81 $\frac{5}{8}$ "w 85 $\frac{3}{4}$ "l  
HB 54"h ■ FB 30"h

**CM-2002-Q (Queen)**  
66 $\frac{1}{8}$ "w 85 $\frac{3}{4}$ "l  
HB 54"h ■ FB 30"h

**CM-2002-F (Full)**  
58 $\frac{7}{8}$ "w 80 $\frac{3}{4}$ "l  
HB 54"h ■ FB 30"h

**CM-2002-T (Twin)**  
44"w 80 $\frac{3}{4}$ "l  
HB 54"h ■ FB 30"h

### Low Footboard

**CM-2003-K (King)**  
81 $\frac{5}{8}$ "w 85 $\frac{3}{4}$ "l  
HB 54"h ■ FB 14 $\frac{3}{4}$ "h

**CM-2003-Q (Queen)**  
66 $\frac{1}{8}$ "w 85 $\frac{3}{4}$ "l  
HB 54"h ■ FB 14 $\frac{3}{4}$ "h

**CM-2003-F (Full)**  
58 $\frac{7}{8}$ "w 80 $\frac{3}{4}$ "l  
HB 54"h ■ FB 14 $\frac{3}{4}$ "h

**CM-2003-T (Twin)**  
44"w 80 $\frac{3}{4}$ "l  
HB 54"h ■ FB 14 $\frac{3}{4}$ "h

### Headboard Only

**CM-2001K-HB (King)**  
54" high

**CM-2001Q-HB (Queen)**  
54" high

**CM-2001F-HB (Full)**  
54" high

**CM-2001T-HB (Twin)**  
54" high



234-SR  
Storage  
Upgrade

Shown with Regular Footboard



## Claremont Slat Bed

Available  
with underbed  
storage options.

### Regular Footboard

**CM-1983-K** (King)  
81 $\frac{1}{8}$ "w 85 $\frac{3}{4}$ "l  
HB 54"h ■ FB 30"h

**CM-1983-Q** (Queen)  
66 $\frac{1}{8}$ "w 85 $\frac{3}{4}$ "l  
HB 54"h ■ FB 30"h

**CM-1983-F** (Full)  
58 $\frac{7}{8}$ "w 80 $\frac{3}{4}$ "l  
HB 54"h ■ FB 30"h

**CM-1983-T** (Twin)  
44"w 80 $\frac{3}{4}$ "l  
HB 54"h ■ FB 30"h

### Low Footboard

**CM-1990-K** (King)  
81 $\frac{1}{8}$ "w 85 $\frac{3}{4}$ "l  
HB 54"h ■ FB 14 $\frac{3}{4}$ "h

**CM-1990-Q** (Queen)  
66 $\frac{1}{8}$ "w 85 $\frac{3}{4}$ "l  
HB 54"h ■ FB 14 $\frac{3}{4}$ "h

**CM-1990-F** (Full)  
58 $\frac{7}{8}$ "w 80 $\frac{3}{4}$ "l  
HB 54"h ■ FB 14 $\frac{3}{4}$ "h

**CM-1990-T** (Twin)  
44"w 80 $\frac{3}{4}$ "l  
HB 54"h ■ FB 14 $\frac{3}{4}$ "h

### Headboard Only

**CM-1982K-HB** (King)  
54" high

**CM-1982Q-HB** (Queen)  
54" high

**CM-1982F-HB** (Full)  
54" high

**CM-1982T-HB** (Twin)  
54" high

## Deluxe Poster Bed

Available  
with underbed  
storage options.

### Regular Footboard

**DP-2685-K** (King)  
81 $\frac{1}{8}$ "w 89"l  
HB 69 $\frac{1}{2}$ "h ■ FB 62"h

**DP-2685-Q** (Queen)  
66"w 89"l  
HB 69 $\frac{1}{2}$ "h ■ FB 62"h

**DP-2685-F** (Full)  
58 $\frac{7}{8}$ "w 84"l  
HB 69 $\frac{1}{2}$ "h ■ FB 62"h

**DP-2685-T** (Twin)  
44"w 84"l  
HB 69 $\frac{1}{2}$ "h ■ FB 62"h

### Headboard Only

**DP-2687K-HB** (King)  
69 $\frac{1}{2}$ " high

**DP-2687Q-HB** (Queen)  
69 $\frac{1}{2}$ " high

**DP-2687F-HB** (Full)  
69 $\frac{1}{2}$ " high

**DP-2687T-HB** (Twin)  
69 $\frac{1}{2}$ " high



Shown with Regular Footboard



Shown with Regular Footboard

## Double Bow Bed

Available with underbed storage options.

### Regular Footboard

**LE-480-K (King)**

79 1/4"w 87"l  
HB 47 1/4"h ■ FB 36 1/4"h

**LE-480-Q (Queen)**

63 1/2"w 87"l  
HB 47 1/4"h ■ FB 36 1/4"h

**LE-480-F (Full)**

57"w 82"l  
HB 47 1/4"h ■ FB 36 1/4"h

**LE-480-T (Twin)**

41 1/4"w 82"l  
HB 47 1/4"h ■ FB 36 1/4"h

### Low Footboard

**LE-479-K (King)**

79 1/4"w 85 3/4"l  
HB 47 1/4"h ■ FB 14 3/4"h

**LE-479-Q (Queen)**

63 1/2"w 85 3/4"l  
HB 47 1/4"h ■ FB 14 3/4"h

**LE-479-F (Full)**

57"w 80 3/4"l  
HB 47 1/4"h ■ FB 14 3/4"h

**LE-479-T (Twin)**

41 1/4"w 80 3/4"l  
HB 47 1/4"h ■ FB 14 3/4"h

### Headboard Only

**LE-478-HB-K (King)**

47 1/4" high

**LE-478-HB-Q (Queen)**

47 1/4" high

**LE-478-HB-F (Full)**

47 1/4" high

**LE-478-HB-T (Twin)**

47 1/4" high

## Dowel Bed

Available with underbed storage options.

### Regular Footboard

**LE-481-K (King)**

85"w 87"l  
HB 54 1/2"h ■ FB 38 1/2"h

**LE-481-Q (Queen)**

69"w 87"l  
HB 52 1/2"h ■ FB 36 1/2"h

**LE-481-F (Full)**

62 1/2"w 82"l  
HB 51"h ■ FB 35"h

**LE-481-T (Twin)**

46 1/2"w 82"l  
HB 49"h ■ FB 33"h

### Low Footboard

**LE-483-K (King)**

85"w 85 3/4"l  
HB 54 1/2"h ■ FB 14 3/4"h

**LE-483-Q (Queen)**

69"w 85 3/4"l  
HB 52 1/2"h ■ FB 14 3/4"h

**LE-483-F (Full)**

62 1/2"w 80 3/4"l  
HB 51"h ■ FB 14 3/4"h

**LE-483-T (Twin)**

46 1/2"w 80 3/4"l  
HB 49"h ■ FB 14 3/4"h

### Headboard Only

**LE-485K-HB (King)**

54 1/2" high

**LE-485Q-HB (Queen)**

52 1/2" high

**LE-485F-HB (Full)**

51" high

**LE-485T-HB (Twin)**

49" high



532-SR  
Storage  
Upgrade

Shown with Regular Footboard



234-SR  
Storage  
Upgrade

Shown with Low Footboard

## Dreamland Bed

### Regular Footboard

Available  
with underbed  
storage options.

**CA-595-K** (King)  
79 3/8"w 84 1/2"l  
HB 48"h ■ FB 30"h

**CA-595-Q** (Queen)  
64 1/8"w 84 1/2"l  
HB 48"h ■ FB 30"h

**CA-595-F** (Full)  
56 7/8"w 79 1/2"l  
HB 48"h ■ FB 30"h

**CA-595-T** (Twin)  
42"w 79 1/2"l  
HB 48"h ■ FB 30"h

### Low Footboard

**CA-597-K** (King)  
79 3/8"w 84 1/2"l  
HB 48"h ■ FB 14 3/4"h

**CA-597-Q** (Queen)  
64 1/8"w 84 1/2"l  
HB 48"h ■ FB 14 3/4"h

**CA-597-F** (Full)  
56 7/8"w 79 1/2"l  
HB 48"h ■ FB 14 3/4"h

**CA-597-T** (Twin)  
42"w 79 1/2"l  
HB 48"h ■ FB 14 3/4"h

### Headboard Only

**CA-599K-HB** (King)  
48" high

**CA-599Q-HB** (Queen)  
48" high

**CA-599F-HB** (Full)  
48" high

**CA-599T-HB** (Twin)  
48" high

## Elk Ridge Sleigh Bed

Available  
with underbed  
storage options.

### Regular Footboard

**ER-1930-K** (King)  
79 3/8"w 93"l  
HB 59"h ■ FB 30"h

**ER-1930-Q** (Queen)  
64"w 93"l  
HB 59"h ■ FB 30"h

**ER-1930-F** (Full)  
56 7/8"w 88"l  
HB 59"h ■ FB 30"h

**ER-1930-T** (Twin)  
42"w 88"l  
HB 59"h ■ FB 30"h

### Low Footboard

**ER-1932-K** (King)  
79 3/8"w 88 3/4"l  
HB 59"h ■ FB 14 3/4"h

**ER-1932-Q** (Queen)  
64"w 88 3/4"l  
HB 59"h ■ FB 14 3/4"h

**ER-1932-F** (Full)  
56 7/8"w 83 3/4"l  
HB 59"h ■ FB 14 3/4"h

**ER-1932-T** (Twin)  
42"w 83 3/4"l  
HB 59"h ■ FB 14 3/4"h

### Headboard Only

**ER-1940K-HB** (King)  
59" high

**ER-1940Q-HB** (Queen)  
59" high

**ER-1940F-HB** (Full)  
59" high

**ER-1940T-HB** (Twin)  
59" high



**Post Height  
84"**  
Posts are  
removable

Shown with Regular Footboard



**234-SR  
Storage  
Upgrade**

Shown with Regular Footboard

## Glendale Poster Bed

Available  
with underbed  
storage options.

### Regular Footboard

**GD-1890-K (King)**  
80 1/8"w 87 1/2"l  
HB 48"h ■ FB 14"h

**GD-1890-Q (Queen)**  
64 3/8"w 87 1/2"l  
HB 48"h ■ FB 14"h

**GD-1890-F (Full)**  
57 3/8"w 82 1/2"l  
HB 48"h ■ FB 14"h

**GD-1890-T (Twin)**  
42 1/2"w 82 1/2"l  
HB 48"h ■ FB 14"h

### Headboard Only

**GD-1900K-HB (King)**  
48" high

**GD-1900Q-HB (Queen)**  
48" high

**GD-1900F-HB (Full)**  
48" high

**GD-1900T-HB (Twin)**  
48" high

## Hamilton Bed Regular Footboard

Available  
with underbed  
storage options.

**HM-1880-K (King)**  
82 3/4"w 86 1/8"l  
HB 60"h ■ FB 22"h

**HM-1880-Q (Queen)**  
67 1/4"w 86 1/8"l  
HB 60"h ■ FB 22"h

**HM-1880-F (Full)**  
60 1/8"w 81 1/8"l  
HB 60"h ■ FB 22"h

**HM-1880-T (Twin)**  
45 1/4"w 81 1/8"l  
HB 60"h ■ FB 22"h

### Low Footboard

**HM-1882-K (King)**  
82 3/4"w 84 1/2"l  
HB 60"h ■ FB 14 3/4"h

**HM-1882-Q (Queen)**  
67 1/4"w 84 1/2"l  
HB 60"h ■ FB 14 3/4"h

**HM-1882-F (Full)**  
60 1/8"w 79 1/2"l  
HB 60"h ■ FB 14 3/4"h

**HM-1882-T (Twin)**  
45 1/4"w 79 1/2"l  
HB 60"h ■ FB 14 3/4"h

### Headboard Only

**HM-1885K-HB (King)**  
60" high

**HM-1885Q-HB (Queen)**  
60" high

**HM-1885F-HB (Full)**  
60" high

**HM-1885T-HB (Twin)**  
60" high



Shown with Regular Footboard



Shown with Regular Footboard

## Huntington Bed Regular Footboard

Available  
with underbed  
storage options.

**HT-2125K** (King)  
83<sup>5</sup>/<sub>8</sub>"w 91"l  
HB 63<sup>1</sup>/<sub>4</sub>"h ■ FB 29"h

**HT-2125Q** (Queen)  
68"w 91"l  
HB 63<sup>1</sup>/<sub>4</sub>"h ■ FB 29"h

**HT-2125F** (Full)  
60<sup>7</sup>/<sub>8</sub>"w 86"l  
HB 63<sup>1</sup>/<sub>4</sub>"h ■ FB 29"h

**HT-2125T** (Twin)  
46"w 86"l  
HB 63<sup>1</sup>/<sub>4</sub>"h ■ FB 29"h

## Low Footboard

**HT-2126K** (King)  
83<sup>5</sup>/<sub>8</sub>"w 87<sup>3</sup>/<sub>4</sub>"l  
HB 63<sup>1</sup>/<sub>4</sub>"h ■ FB 14<sup>3</sup>/<sub>4</sub>"h

**HT-2126Q** (Queen)  
68"w 87<sup>3</sup>/<sub>4</sub>"l  
HB 63<sup>1</sup>/<sub>4</sub>"h ■ FB 14<sup>3</sup>/<sub>4</sub>"h

**HT-2126F** (Full)  
60<sup>7</sup>/<sub>8</sub>"w 82<sup>3</sup>/<sub>4</sub>"l  
HB 63<sup>1</sup>/<sub>4</sub>"h ■ FB 14<sup>3</sup>/<sub>4</sub>"h

**HT-2126T** (Twin)  
46"w 82<sup>3</sup>/<sub>4</sub>"l  
HB 63<sup>1</sup>/<sub>4</sub>"h ■ FB 14<sup>3</sup>/<sub>4</sub>"h

## Headboard Only

**HT-2127K-HB** (King)  
63<sup>1</sup>/<sub>4</sub>" high

**HT-2127Q-HB** (Queen)  
63<sup>1</sup>/<sub>4</sub>" high

**HT-2127F-HB** (Full)  
63<sup>1</sup>/<sub>4</sub>" high

**HT-2127T-HB** (Twin)  
63<sup>1</sup>/<sub>4</sub>" high

## Low Modern Bed Regular Footboard

Available  
with underbed  
storage options.

**LM-2366-K** (King)  
84<sup>5</sup>/<sub>8</sub>"w 86<sup>1</sup>/<sub>4</sub>"l  
HB 46"h ■ FB 14<sup>3</sup>/<sub>4</sub>"h

**LM-2366-Q** (Queen)  
69"w 86<sup>1</sup>/<sub>4</sub>"l  
HB 46"h ■ FB 14<sup>3</sup>/<sub>4</sub>"h

**LM-2366-F** (Full)  
61<sup>7</sup>/<sub>8</sub>"w 81<sup>1</sup>/<sub>4</sub>"l  
HB 46"h ■ FB 14<sup>3</sup>/<sub>4</sub>"h

**LM-2366-T** (Twin)  
47"w 81<sup>1</sup>/<sub>4</sub>"l  
HB 46"h ■ FB 14<sup>3</sup>/<sub>4</sub>"h

## Headboard Only

**LM-2367-K-HB** (King)  
46" high

**LM-2367-Q-HB** (Queen)  
46" high

**LM-2367-F-HB** (Full)  
46" high

**LM-2367-T-HB** (Twin)  
46" high



Shown with Low Footboard



Shown with Regular Footboard

## Lewiston Bed Regular Footboard

Available  
with underbed  
storage options.

**LN-2365-K (King)**  
80 1/8"w 85 1/2"l  
HB 54"h ■ FB 30 1/4"h

**LN-2365-Q (Queen)**  
64 1/2"w 85 1/2"l  
HB 54"h ■ FB 30 1/4"h

**LN-2365-F (Full)**  
57 3/8"w 80 1/2"l  
HB 54"h ■ FB 30 1/4"h

**LN-2365-T (Twin)**  
42 1/2"w 80 1/2"l  
HB 54"h ■ FB 30 1/4"h

## Low Footboard

**LN-2366-K (King)**  
80 1/8"w 84 1/2"l  
HB 54"h ■ FB 16"h

**LN-2366-Q (Queen)**  
64 1/2"w 84 1/2"l  
HB 54"h ■ FB 16"h

**LN-2366-F (Full)**  
57 3/8"w 79 1/2"l  
HB 54"h ■ FB 16"h

**LN-2366-T (Twin)**  
42 1/2"w 79 1/2"l  
HB 54"h ■ FB 16"h

## Headboard Only

**LN-2367K-HB (King)**  
54" high

**LN-2367Q-HB (Queen)**  
54" high

**LN-2367F-HB (Full)**  
54" high

**LN-2367T-HB (Twin)**  
54" high

## Lindenhurst Sleigh Bed Regular Footboard

Available  
with underbed  
storage options.

**LH-1520-K (King)**  
79 1/8"w 89 1/4"l  
HB 48"h ■ FB 30"h

**LH-1520-Q (Queen)**  
63 3/8"w 89 1/4"l  
HB 48"h ■ FB 30"h

**LH-1520-F (Full)**  
56 3/8"w 85 1/4"l  
HB 48"h ■ FB 30"h

**LH-1520-T (Twin)**  
41 5/8"w 85 1/4"l  
HB 48"h ■ FB 30"h

## Low Footboard

**LH-1522-K (King)**  
79 1/8"w 89 3/8"l  
HB 48"h ■ FB 14 3/4"h

**LH-1522-Q (Queen)**  
63 3/8"w 89 3/8"l  
HB 48"h ■ FB 14 3/4"h

**LH-1522-F (Full)**  
56 3/8"w 84 3/8"l  
HB 48"h ■ FB 14 3/4"h

**LH-1522-T (Twin)**  
41 5/8"w 84 3/8"l  
HB 48"h ■ FB 14 3/4"h

## Headboard Only

**LH-1525-HB-K (King)**  
48" high

**LH-1525-HB-Q (Queen)**  
48" high

**LH-1525-HB-F (Full)**  
48" high

**LH-1525-HB-T (Twin)**  
48" high



Shown with Regular Footboard



Shown with Regular Footboard

## Luellen Bed

### Regular Footboard

Available with underbed storage options.

**LE-1451-K** (King)  
83 $\frac{3}{8}$ "w 91"l  
HB 65 $\frac{7}{8}$ "h ■ FB 35 $\frac{7}{8}$ "h

**LE-1451-Q** (Queen)  
68 $\frac{1}{8}$ "w 91"l  
HB 65 $\frac{7}{8}$ "h ■ FB 35 $\frac{7}{8}$ "h

**LE-1451-F** (Full)  
60 $\frac{7}{8}$ "w 86"l  
HB 65 $\frac{7}{8}$ "h ■ FB 35 $\frac{7}{8}$ "h

**LE-1451-T** (Twin)  
46"w 86"l  
HB 65 $\frac{7}{8}$ "h ■ FB 35 $\frac{7}{8}$ "h

### Low Footboard

**LE-1457-K** (King)  
83 $\frac{3}{8}$ "w 87 $\frac{3}{4}$ "l  
HB 65 $\frac{7}{8}$ "h ■ FB 14 $\frac{3}{4}$ "h

**LE-1457-Q** (Queen)  
68 $\frac{1}{8}$ "w 87 $\frac{3}{4}$ "l  
HB 65 $\frac{7}{8}$ "h ■ FB 14 $\frac{3}{4}$ "h

**LE-1457-F** (Full)  
60 $\frac{7}{8}$ "w 82 $\frac{3}{4}$ "l  
HB 65 $\frac{7}{8}$ "h ■ FB 14 $\frac{3}{4}$ "h

**LE-1457-T** (Twin)  
46"w 82 $\frac{3}{4}$ "l  
HB 65 $\frac{7}{8}$ "h ■ FB 14 $\frac{3}{4}$ "h

### Headboard Only

**LE-1463K-HB** (King)  
65 $\frac{7}{8}$ " high

**LE-1463Q-HB** (Queen)  
65 $\frac{7}{8}$ " high

**LE-1463F-HB** (Full)  
65 $\frac{7}{8}$ " high

**LE-1463T-HB** (Twin)  
65 $\frac{7}{8}$ " high

## Manhattan Curved Bed

### Regular Footboard

Available with underbed storage options.

**MH-2171-K** (King)  
82 $\frac{1}{8}$ "w 87"l  
HB 59 $\frac{1}{4}$ "h ■ FB 30 $\frac{1}{4}$ "h

**MH-2171-Q** (Queen)  
66 $\frac{1}{2}$ "w 87"l  
HB 57 $\frac{1}{4}$ "h ■ FB 30 $\frac{1}{4}$ "h

**MH-2171-F** (Full)  
59 $\frac{3}{8}$ "w 82"l  
HB 55 $\frac{3}{4}$ "h ■ FB 30 $\frac{1}{4}$ "h

**MH-2171-T** (Twin)  
44 $\frac{1}{2}$ "w 82"l  
HB 53 $\frac{3}{4}$ "h ■ FB 30 $\frac{1}{4}$ "h

### Low Footboard

**MH-2178-K** (King)  
82 $\frac{1}{8}$ "w 85 $\frac{3}{4}$ "l  
HB 59 $\frac{1}{4}$ "h ■ FB 14 $\frac{3}{4}$ "h

**MH-2178-Q** (Queen)  
66 $\frac{1}{2}$ "w 85 $\frac{3}{4}$ "l  
HB 57 $\frac{1}{4}$ "h ■ FB 14 $\frac{3}{4}$ "h

**MH-2178-F** (Full)  
59 $\frac{3}{8}$ "w 80 $\frac{3}{4}$ "l  
HB 55 $\frac{3}{4}$ "h ■ FB 14 $\frac{3}{4}$ "h

**MH-2178-T** (Twin)  
44 $\frac{1}{2}$ "w 80 $\frac{3}{4}$ "l  
HB 53 $\frac{3}{4}$ "h ■ FB 14 $\frac{3}{4}$ "h

### Headboard Only

**MH-2170K-HB** (King)  
59 $\frac{1}{4}$ " high

**MH-2170Q-HB** (Queen)  
57 $\frac{1}{4}$ " high

**MH-2170F-HB** (Full)  
55 $\frac{3}{4}$ " high

**MH-2170T-HB** (Twin)  
53 $\frac{3}{4}$ " high



Shown with Regular Footboard



Shown with Regular Footboard

## Manhattan Panel Bed

Available with underbed storage options.

### Regular Footboard

**MH-2174-K (King)**  
82 $\frac{1}{8}$ "w 86 $\frac{1}{2}$ "l  
HB 53"h ■ FB 30"h

**MH-2174-Q (Queen)**  
66 $\frac{1}{2}$ "w 86 $\frac{1}{2}$ "l  
HB 53"h ■ FB 30"h

**MH-2174-F (Full)**  
59 $\frac{3}{8}$ "w 81 $\frac{1}{2}$ "l  
HB 53"h ■ FB 30"h

**MH-2174-T (Twin)**  
44 $\frac{1}{2}$ "w 81 $\frac{1}{2}$ "l  
HB 53"h ■ FB 30"h

### Low Footboard

**MH-2175-K (King)**  
82 $\frac{1}{8}$ "w 85 $\frac{1}{2}$ "l  
HB 53"h ■ FB 14 $\frac{3}{4}$ "h

**MH-2175-Q (Queen)**  
66 $\frac{1}{2}$ "w 85 $\frac{1}{2}$ "l  
HB 53"h ■ FB 14 $\frac{3}{4}$ "h

**MH-2175-F (Full)**  
59 $\frac{3}{8}$ "w 80 $\frac{1}{2}$ "l  
HB 53"h ■ FB 14 $\frac{3}{4}$ "h

**MH-2175-T (Twin)**  
44 $\frac{1}{2}$ "w 80 $\frac{1}{2}$ "l  
HB 53"h ■ FB 14 $\frac{3}{4}$ "h

### Headboard Only

**MH-2173K-HB (King)**  
53" high

**MH-2173Q-HB (Queen)**  
53" high

**MH-2173F-HB (Full)**  
53" high

**MH-2173T-HB (Twin)**  
53" high

## Monticello Bed

Available with underbed storage options.

### Regular Footboard

**MO-1410-K (King)**  
83 $\frac{5}{8}$ "w 89 $\frac{1}{2}$ "l  
HB 60"h ■ FB 15 $\frac{3}{4}$ "h

**MO-1410-F (Full)**  
60 $\frac{7}{8}$ "w 84 $\frac{1}{2}$ "l  
HB 48"h ■ FB 15 $\frac{3}{4}$ "h

**MO-1410-Q (Queen)**  
68"w 89 $\frac{1}{2}$ "l  
HB 60"h ■ FB 15 $\frac{3}{4}$ "h

**MO-1410-T (Twin)**  
46"w 84 $\frac{1}{2}$ "l  
HB 60"h ■ FB 15 $\frac{3}{4}$ "h

### Headboard Only

**MO-1417-K-HB (King)**  
60" high

**MO-1417-F-HB (Full)**  
60" high

**MO-1417-Q-HB (Queen)**  
60" high

**MO-1417-T-HB (Twin)**  
60" high



Shown with Regular Footboard



Shown with Regular Footboard and 234 Storage Upgrade

## Olde Cottage Bed

Available with underbed storage options.

### Regular Footboard

**OD-2765-K** (King)  
81 $\frac{5}{8}$ "w 87 $\frac{1}{2}$ "l  
HB 56"h ■ FB 17"h

**OD-2765-Q** (Queen)  
66"w 87 $\frac{1}{2}$ "l  
HB 56"h ■ FB 17"h

**OD-2765-F** (Full)  
58 $\frac{7}{8}$ "w 82 $\frac{1}{2}$ "l  
HB 56"h ■ FB 17"h

**OD-2765-T** (Twin)  
44"w 82 $\frac{1}{2}$ "l  
HB 56"h ■ FB 17"h

### Low Footboard

**OD-2766-K** (King)  
81 $\frac{5}{8}$ "w 86"l  
HB 56"h ■ FB 14 $\frac{3}{4}$ "h

**OD-2766-Q** (Queen)  
66"w 86"l  
HB 56"h ■ FB 14 $\frac{3}{4}$ "h

**OD-2766-F** (Full)  
58 $\frac{7}{8}$ "w 81"l  
HB 56"h ■ FB 14 $\frac{3}{4}$ "h

**OD-2766-T** (Twin)  
44"w 81"l  
HB 56"h ■ FB 14 $\frac{3}{4}$ "h

### Headboard Only

**OD-2767K-HB** (King)  
56" high

**OD-2767Q-HB** (Queen)  
56" high

**OD-2767F-HB** (Full)  
56" high

**OD-2767T-HB** (Twin)  
56" high

## Open Sleigh Bed

Available with underbed storage options.

### Regular Footboard

**OS-2695-K** (King)  
79"w 94"l  
HB 53"h ■ FB 33"h

**OS-2695-Q** (Queen)  
63 $\frac{5}{8}$ "w 94"l  
HB 53"h ■ FB 33"h

**OS-2695-F** (Full)  
56 $\frac{1}{2}$ "w 89"l  
HB 53"h ■ FB 33"h

**OS-2695-T** (Twin)  
41 $\frac{5}{8}$ "w 89"l  
HB 53"h ■ FB 33"h

### Low Footboard

**OS-2696-K** (King)  
79"w 89 $\frac{3}{4}$ "l  
HB 53"h ■ FB 14 $\frac{3}{4}$ "h

**OS-2696-Q** (Queen)  
63 $\frac{5}{8}$ "w 89 $\frac{3}{4}$ "l  
HB 53"h ■ FB 14 $\frac{3}{4}$ "h

**OS-2696-F** (Full)  
56 $\frac{1}{2}$ "w 84 $\frac{3}{4}$ "l  
HB 53"h ■ FB 14 $\frac{3}{4}$ "h

**OS-2696-T** (Twin)  
41 $\frac{5}{8}$ "w 84 $\frac{3}{4}$ "l  
HB 53"h ■ FB 14 $\frac{3}{4}$ "h

### Headboard Only

**OS-2697K-HB** (King)  
53" high

**OS-2697Q-HB** (Queen)  
53" high

**OS-2697F-HB** (Full)  
53" high

**OS-2697T-HB** (Twin)  
53" high



Shown with Regular Footboard



Shown with Regular Footboard

## Panel Bed

### Regular Footboard

Available  
with underbed  
storage options.

**SO-1050-K (King)**  
82¼" w 87½" l  
HB 52¾" h ■ FB 30¾" h

**SO-1050-Q (Queen)**  
66⅝" w 87½" l  
HB 52¾" h ■ FB 30¾" h

**SO-1050-F (Full)**  
59½" w 82½" l  
HB 52¾" h ■ FB 30¾" h

**SO-1050-T (Twin)**  
44¾" w 82½" l  
HB 52¾" h ■ FB 30¾" h

### Low Footboard

**SO-1052-K (King)**  
82¼" w 85¾" l  
HB 52¾" h ■ FB 14¾" h

**SO-1052-Q (Queen)**  
66⅝" w 85¾" l  
HB 52¾" h ■ FB 14¾" h

**SO-1052-F (Full)**  
59½" w 80¾" l  
HB 52¾" h ■ FB 14¾" h

**SO-1052-T (Twin)**  
44¾" w 80¾" l  
HB 52¾" h ■ FB 14¾" h

### Headboard Only

**SO-1054K-HB (King)**  
52¾" high

**SO-1054Q-HB (Queen)**  
52¾" high

**SO-1054F-HB (Full)**  
52¾" high

**SO-1054T-HB (Twin)**  
52¾" high

## Prairie Bed

### Regular Footboard

Available  
with underbed  
storage options.

**PI-1122-K (King)**  
81⅝" w 84½" l  
HB 53" h ■ FB 30" h

**PI-1122-Q (Queen)**  
66" w 84½" l  
HB 53" h ■ FB 30" h

**PI-1122-F (Full)**  
58⅞" w 79½" l  
HB 53" h ■ FB 30" h

**PI-1122-T (Twin)**  
44" w 79½" l  
HB 53" h ■ FB 30" h

### Low Footboard

**PI-1124-K (King)**  
81⅝" w 84½" l  
HB 53" h ■ FB 14¾" h

**PI-1124-Q (Queen)**  
66" w 84½" l  
HB 53" h ■ FB 14¾" h

**PI-1124-F (Full)**  
58⅞" w 79½" l  
HB 53" h ■ FB 14¾" h

**PI-1124-T (Twin)**  
44" w 79½" l  
HB 53" h ■ FB 14¾" h

### Headboard Only

**PI-1126K-HB (King)**  
53" high

**PI-1126Q-HB (Queen)**  
53" high

**PI-1126F-HB (Full)**  
53" high

**PI-1126T-HB (Twin)**  
53" high



Shown with Regular Footboard



532-SR  
Storage  
Upgrade

Shown with Regular Footboard

## Rainbow Panel Bed

Available with underbed storage options.

### Regular Footboard

**CA-441-K (King)**  
85¾" w 87" l  
HB 59¼" h ■ FB 30¼" h

**CA-441-Q (Queen)**  
70¼" w 87" l  
HB 57¼" h ■ FB 30¼" h

**CA-441-F (Full)**  
63" w 82" l  
HB 55¾" h ■ FB 30¼" h

**CA-441-T (Twin)**  
48⅞" w 82" l  
HB 53¾" h ■ FB 30¼" h

### Low Footboard

**CA-443-K (King)**  
85¾" w 85¾" l  
HB 59¼" h ■ FB 14¾" h

**CA-443-Q (Queen)**  
70¼" w 85¾" l  
HB 57¼" h ■ FB 14¾" h

**CA-443-F (Full)**  
63" w 80¾" l  
HB 55¾" h ■ FB 14¾" h

**CA-443-T (Twin)**  
48⅞" w 80¾" l  
HB 53¾" h ■ FB 14¾" h

### Headboard Only

**CA-446K-HB (King)**  
59¼" high

**CA-446Q-HB (Queen)**  
57¼" high

**CA-446F-HB (Full)**  
55¾" high

**CA-446T-HB (Twin)**  
53¾" high

## Rainbow Spindle Bed

Available with underbed storage options.

### Regular Footboard

**CA-527-K (King)**  
85¾" w 87" l  
HB 59¼" h ■ FB 30¼" h

**CA-527-Q (Queen)**  
70¼" w 87" l  
HB 57¼" h ■ FB 30¼" h

**CA-527-F (Full)**  
63" w 82" l  
HB 55¾" h ■ FB 30¼" h

**CA-527-T (Twin)**  
48⅞" w 82" l  
HB 53¾" h ■ FB 30¼" h

### Low Footboard

**CA-529-K (King)**  
85¾" w 85¾" l  
HB 59¼" h ■ FB 14¾" h

**CA-529-Q (Queen)**  
70¼" w 85¾" l  
HB 57¼" h ■ FB 14¾" h

**CA-529-F (Full)**  
63" w 80¾" l  
HB 55¾" h ■ FB 14¾" h

**CA-529-T (Twin)**  
48⅞" w 80¾" l  
HB 53¾" h ■ FB 14¾" h

### Headboard Only

**CA-531K-HB (King)**  
59¼" high

**CA-531Q-HB (Queen)**  
57¼" high

**CA-531F-HB (Full)**  
55¾" high

**CA-531T-HB (Twin)**  
53¾" high



Shown with Regular Footboard  
and **532 Storage Upgrade**



Shown with Regular Footboard

## Regency Bed Regular Footboard

Available  
with underbed  
storage options.

**RG-2665-K** (King)  
79½"w 96½"l  
HB 58"h ■ FB 38½"h

**RG-2665-Q** (Queen)  
64½"w 96½"l  
HB 58"h ■ FB 38½"h

**RG-2665-F** (Full)  
57"w 91½"l  
HB 58"h ■ FB 38½"h

**RG-2665-T** (Twin)  
42½"w 91½"l  
HB 58"h ■ FB 38½"h

## Low Footboard

**RG-2666-K** (King)  
79½"w 90¾"l  
HB 58"h ■ FB 14¾"h

**RG-2666-Q** (Queen)  
64½"w 90¾"l  
HB 58"h ■ FB 14¾"h

**RG-2666-F** (Full)  
57"w 85¾"l  
HB 58"h ■ FB 14¾"h

**RG-2666-T** (Twin)  
42½"w 85¾"l  
HB 58"h ■ FB 14¾"h

## Headboard Only

**RG-2667K-HB** (King)  
58" high

**RG-2667Q-HB** (Queen)  
58" high

**LN-2667F-HB** (Full)  
58" high

**LN-2667T-HB** (Twin)  
58" high

## Rosedale Bed Regular Footboard

Available  
with underbed  
storage options.

**RD-3165-K** (King)  
82½"w 87"l  
HB 58"h ■ FB 18"h

**RD-3165-Q** (Queen)  
66½"w 87"l  
HB 58"h ■ FB 18"h

**RD-3165-F** (Full)  
59¾"w 82"l  
HB 58"h ■ FB 18"h

**RD-3165-T** (Twin)  
44½"w 82"l  
HB 58"h ■ FB 18"h

## Low Footboard

**RD-3166-K** (King)  
82½"w 85¼"l  
HB 58"h ■ FB 14¾"h

**RD-3166-Q** (Queen)  
66½"w 85¼"l  
HB 58"h ■ FB 14¾"h

**RD-3166-F** (Full)  
59¾"w 80¼"l  
HB 58"h ■ FB 14¾"h

**RD-3166-T** (Twin)  
44½"w 80¼"l  
HB 58"h ■ FB 14¾"h

## Headboard Only

**RD-3167K-HB** (King)  
58" high

**RD-3167Q-HB** (Queen)  
58" high

**RD-3167F-HB** (Full)  
58" high

**RD-3167T-HB** (Twin)  
58" high



**Post Height  
80"**  
Posts are  
removable

Shown with Regular Footboard



Shown with Regular Footboard

## Rosewood Poster Bed

Available  
with underbed  
storage options.

### Regular Footboard

**RW-1910-K** (King)  
80 1/8"w 87 1/2"l  
HB 52"h ■ FB 23"h

**RW-1910-Q** (Queen)  
64 3/8"w 87 1/2"l  
HB 52"h ■ FB 23"h

**RW-1910-F** (Full)  
57 3/8"w 82 1/2"l  
HB 52"h ■ FB 23"h

**RW-1910-T** (Twin)  
42 1/2"w 82 1/2"l  
HB 52"h ■ FB 23"h

### Headboard Only

**RW-1920K-HB** (King)  
52" high

**RW-1920Q-HB** (Queen)  
52" high

**RW-1920F-HB** (Full)  
52" high

**RW-1920T-HB** (Twin)  
52" high

## Shoreview Bed

Available  
with underbed  
storage options.

### Regular Footboard

**SH-2088-K** (King)  
81 1/2"w 85 1/2"l  
HB 48"h ■ FB 30"h

**SH-2088-Q** (Queen)  
66"w 85 1/2"l  
HB 48"h ■ FB 30"h

**SH-2088-F** (Full)  
58 7/8"w 80 1/2"l  
HB 48"h ■ FB 30"h

**SH-2088-T** (Twin)  
44"w 80 1/2"l  
HB 48"h ■ FB 30"h

### Low Footboard

**SH-2090-K** (King)  
81 1/2"w 84 1/2"l  
HB 48"h ■ FB 14 3/4"h

**SH-2090-Q** (Queen)  
66"w 84 1/2"l  
HB 48"h ■ FB 14 3/4"h

**SH-2090-F** (Full)  
58 7/8"w 79 1/2"l  
HB 48"h ■ FB 14 3/4"h

**SH-2090-T** (Twin)  
44"w 79 1/2"l  
HB 48"h ■ FB 14 3/4"h

### Headboard Only

**SH-2098K-HB** (King)  
48" high

**SH-2098Q-HB** (Queen)  
48" high

**SH-2098F-HB** (Full)  
48" high

**SH-2098T-HB** (Twin)  
48" high



Shown with Regular Footboard



Shown with Regular Footboard

## Single Panel Sleigh Bed

Available with underbed storage options.

### Regular Footboard

**SP-2705-K** (King)  
81½" w 95¼" l  
HB 52" h ■ FB 25" h

**SP-2705-Q** (Queen)  
66½" w 95¼" l  
HB 52" h ■ FB 25" h

**SP-2705-F** (Full)  
59" w 90¼" l  
HB 52" h ■ FB 25" h

**SP-2705-T** (Twin)  
44½" w 90¼" l  
HB 52" h ■ FB 25" h

### Low Footboard

**SP-2706-K** (King)  
81½" w 90¼" l  
HB 52" h ■ FB 14¾" h

**SP-2706-Q** (Queen)  
66½" w 90¼" l  
HB 52" h ■ FB 14¾" h

**SP-2706-F** (Full)  
59" w 85¼" l  
HB 52" h ■ FB 14¾" h

**SP-2706-T** (Twin)  
44½" w 85¼" l  
HB 52" h ■ FB 14¾" h

### Headboard Only

**SP-2707K-HB** (King)  
52" high

**SP-2707Q-HB** (Queen)  
52" high

**SP-2707F-HB** (Full)  
52" high

**SP-2707T-HB** (Twin)  
52" high

## Sleepwell Bed

Available with underbed storage options.

### Regular Footboard

**SW-491-K** (King)  
79⅝" w 84½" l  
HB 48" h ■ FB 30" h

**SW-491-Q** (Queen)  
64⅝" w 84½" l  
HB 48" h ■ FB 30" h

**SW-491-F** (Full)  
56⅞" w 79½" l  
HB 48" h ■ FB 30" h

**SW-491-T** (Twin)  
42" w 79½" l  
HB 48" h ■ FB 30" h

### Low Footboard

**SW-493-K** (King)  
79⅝" w 84½" l  
HB 48" h ■ FB 14¾" h

**SW-493-Q** (Queen)  
64⅝" w 84½" l  
HB 48" h ■ FB 14¾" h

**SW-493-F** (Full)  
56⅞" w 79½" l  
HB 48" h ■ FB 14¾" h

**SW-493-T** (Twin)  
42" w 79½" l  
HB 48" h ■ FB 14¾" h

### Headboard Only

**SW-495K-HB** (King)  
48" high

**SW-495Q-HB** (Queen)  
48" high

**SW-495F-HB** (Full)  
48" high

**SW-495T-HB** (Twin)  
48" high



Shown with Low Footboard



Shown with Low Footboard

## Slumberland Bed

Available  
with underbed  
storage options.

### Regular Footboard

**SL-1061-K** (King)

79<sup>5</sup>/<sub>8</sub>"w 84<sup>1</sup>/<sub>2</sub>"l

HB 50"h ■ FB 30"h

**SL-1061-Q** (Queen)

64<sup>1</sup>/<sub>8</sub>"w 84<sup>1</sup>/<sub>2</sub>"l

HB 50"h ■ FB 30"h

**SL-1061-F** (Full)

56<sup>7</sup>/<sub>8</sub>"w 79<sup>1</sup>/<sub>2</sub>"l

HB 50"h ■ FB 30"h

**SL-1061-T** (Twin)

42"w 79<sup>1</sup>/<sub>2</sub>"l

HB 50"h ■ FB 30"h

### Low Footboard

**SL-1063-K** (King)

79<sup>5</sup>/<sub>8</sub>"w 84<sup>1</sup>/<sub>2</sub>"l

HB 50"h ■ FB 14<sup>3</sup>/<sub>4</sub>"h

**SL-1063-Q** (Queen)

64<sup>1</sup>/<sub>8</sub>"w 84<sup>1</sup>/<sub>2</sub>"l

HB 50"h ■ FB 14<sup>3</sup>/<sub>4</sub>"h

**SL-1063-F** (Full)

56<sup>7</sup>/<sub>8</sub>"w 79<sup>1</sup>/<sub>2</sub>"l

HB 50"h ■ FB 14<sup>3</sup>/<sub>4</sub>"h

**SL-1063-T** (Twin)

42"w 79<sup>1</sup>/<sub>2</sub>"l

HB 50"h ■ FB 14<sup>3</sup>/<sub>4</sub>"h

### Headboard Only

**SL-1065K-HB** (King)

50" high

**SL-1065Q-HB** (Queen)

50" high

**SL-1065F-HB** (Full)

50" high

**SL-1065T-HB** (Twin)

50" high

## Sunrise Queen Bed

Available  
with underbed  
storage options.

### Regular Footboard

**SN-2715-K** (King)

79<sup>5</sup>/<sub>8</sub>"w 84<sup>1</sup>/<sub>2</sub>"l

HB 47<sup>1</sup>/<sub>4</sub>"h ■ FB 30"h

**SN-2715-Q** (Queen)

64"w 84<sup>1</sup>/<sub>2</sub>"l

HB 47<sup>1</sup>/<sub>4</sub>"h ■ FB 30"h

**SN-2715-F** (Full)

56<sup>7</sup>/<sub>8</sub>"w 79<sup>1</sup>/<sub>2</sub>"l

HB 47<sup>1</sup>/<sub>4</sub>"h ■ FB 30"h

**SN-2715-T** (Twin)

42"w 79<sup>1</sup>/<sub>2</sub>"l

HB 47<sup>1</sup>/<sub>4</sub>"h ■ FB 30"h

### Low Footboard

**SN-2716-K** (King)

79<sup>5</sup>/<sub>8</sub>"w 84<sup>1</sup>/<sub>2</sub>"l

HB 47<sup>1</sup>/<sub>4</sub>"h ■ FB 14<sup>3</sup>/<sub>4</sub>"h

**SN-2716-Q** (Queen)

64"w 84<sup>1</sup>/<sub>2</sub>"l

HB 47<sup>1</sup>/<sub>4</sub>"h ■ FB 14<sup>3</sup>/<sub>4</sub>"h

**SN-2716-F** (Full)

56<sup>7</sup>/<sub>8</sub>"w 79<sup>1</sup>/<sub>2</sub>"l

HB 47<sup>1</sup>/<sub>4</sub>"h ■ FB 14<sup>3</sup>/<sub>4</sub>"h

**SN-2716-T** (Twin)

42"w 79<sup>1</sup>/<sub>2</sub>"l

HB 47<sup>1</sup>/<sub>4</sub>"h ■ FB 14<sup>3</sup>/<sub>4</sub>"h

### Headboard Only

**SN-2717K-HB** (King)

47<sup>1</sup>/<sub>4</sub>" high

**SN-2717Q-HB** (Queen)

47<sup>1</sup>/<sub>4</sub>" high

**SN-2717F-HB** (Full)

47<sup>1</sup>/<sub>4</sub>" high

**SN-2717T-HB** (Twin)

47<sup>1</sup>/<sub>4</sub>" high



Shown with Regular Footboard and 685 Storage Upgrade



Shown with Low Footboard

## Timber Mill Bed

Available with underbed storage options.

### Regular Footboard

**TM-3365-K** (King)  
79<sup>3</sup>/<sub>8</sub>"w 85<sup>1</sup>/<sub>2</sub>"l  
HB 55"h ■ FB 33<sup>1</sup>/<sub>4</sub>"h

**TM-3365-Q** (Queen)  
64"w 85<sup>1</sup>/<sub>2</sub>"l  
HB 55"h ■ FB 33<sup>1</sup>/<sub>4</sub>"h

**TM-3365-F** (Full)  
56<sup>7</sup>/<sub>8</sub>"w 80<sup>1</sup>/<sub>2</sub>"l  
HB 55"h ■ FB 33<sup>1</sup>/<sub>4</sub>"h

**TM-3365-T** (Twin)  
42"w 80<sup>1</sup>/<sub>2</sub>"l  
HB 47"h ■ FB 31"h

### Low Footboard

**TM-3366-K** (King)  
79<sup>3</sup>/<sub>4</sub>"w 85"l  
HB 55"h ■ FB 14<sup>3</sup>/<sub>4</sub>"h

**TM-3366-Q** (Queen)  
64"w 85"l  
HB 55"h ■ FB 14<sup>3</sup>/<sub>4</sub>"h

**TM-3366-F** (Full)  
56<sup>7</sup>/<sub>8</sub>"w 80"l  
HB 55"h ■ FB 14<sup>3</sup>/<sub>4</sub>"h

**TM-3366-T** (Twin)  
42"w 80"l  
HB 55"h ■ FB 14<sup>3</sup>/<sub>4</sub>"h

### Headboard Only

**TM-3367K-HB** (King)  
55" high

**TM-3367Q-HB** (Queen)  
55" high

**TM-3367F-HB** (Full)  
55" high

**TM-3367T-HB** (Twin)  
55" high

## Wilkenburg Bed

Available with underbed storage options.

### Regular Footboard

**WB-1736-K** (King)  
81<sup>5</sup>/<sub>8</sub>"w 86<sup>1</sup>/<sub>2</sub>"l  
HB 53"h ■ FB 30"h

**WB-1736-Q** (Queen)  
66"w 86<sup>1</sup>/<sub>2</sub>"l  
HB 53"h ■ FB 30"h

**WB-1736-F** (Full)  
58<sup>7</sup>/<sub>8</sub>"w 81<sup>1</sup>/<sub>2</sub>"l  
HB 53"h ■ FB 30"h

**WB-1736-T** (Twin)  
44"w 81<sup>1</sup>/<sub>2</sub>"l  
HB 53"h ■ FB 30"h

### Low Footboard

**WB-1738-K** (King)  
81<sup>5</sup>/<sub>8</sub>"w 85<sup>1</sup>/<sub>2</sub>"l  
HB 53"h ■ FB 14<sup>3</sup>/<sub>4</sub>"h

**WB-1738-Q** (Queen)  
66"w 85<sup>1</sup>/<sub>2</sub>"l  
HB 53"h ■ FB 14<sup>3</sup>/<sub>4</sub>"h

**WB-1738-F** (Full)  
58<sup>7</sup>/<sub>8</sub>"w 80<sup>1</sup>/<sub>2</sub>"l  
HB 53"h ■ FB 14<sup>3</sup>/<sub>4</sub>"h

**WB-1738-T** (Twin)  
44"w 80<sup>1</sup>/<sub>2</sub>"l  
HB 53"h ■ FB 14<sup>3</sup>/<sub>4</sub>"h

### Headboard Only

**WB-1741K-HB** (King)  
53" high

**WB-1741Q-HB** (Queen)  
53" high

**WB-1741F-HB** (Full)  
53" high

**WB-1741T-HB** (Twin)  
53" high